



Your hometown newspaper serving Northville for 136 years

Thursday, September 14, 2006

northvillerecord.com

50¢

Volume 137 Number 9

Northville, Michigan

## Look inside for your GREEN SHEET Classifieds

Greensheetclassifieds.com

## What you NEED to KNOW

### What's the plan?

The Northville Parks and Recreation Department is inviting residents to attend an informal workshop to discuss updating its five-year master plan. The 4-7 p.m. meeting is scheduled for Tuesday, Sept. 26 at Northville Township Hall, 44405 W. Six Mile Road.

### What's Going On?

#### In town

See what's happening locally this weekend by checking out Northville's official events calendar. Page 16A.

What's Going On? residents may dispose of household hazardous waste locally 8 a.m.-4 p.m. Saturday, Sept. 23. There is no charge for the community effort. Materials will be collected at the city's Department of Public Works yard, 650 Doheny Drive. Page 3A.

#### What a waste!

Northville residents may dispose of household hazardous waste locally 8 a.m.-4 p.m. Saturday, Sept. 23. There is no charge for the community effort. Materials will be collected at the city's Department of Public Works yard, 650 Doheny Drive. Page 3A.

For breaking news in Northville, click www.northvillerecord.com

## Obituaries

Austin "Mike" Allen, 91  
Paul Eagan, 94  
John Stubenvoll, 87  
Janet H. Miller, 81  
Marie E. Durham, 90  
— Page 6A

## INDEX

Classifieds.....3D  
Class Notes.....11A  
Opinion.....14A  
It's Always Something.....5A  
Obituaries.....6A  
Sports.....1B  
What's Going On?.....16A

## CONTACT US

Classifieds: (888) 999-1288  
Newsroom: (248) 349-1700  
Home Delivery: (888) 840-4809



6 53174 33333 9

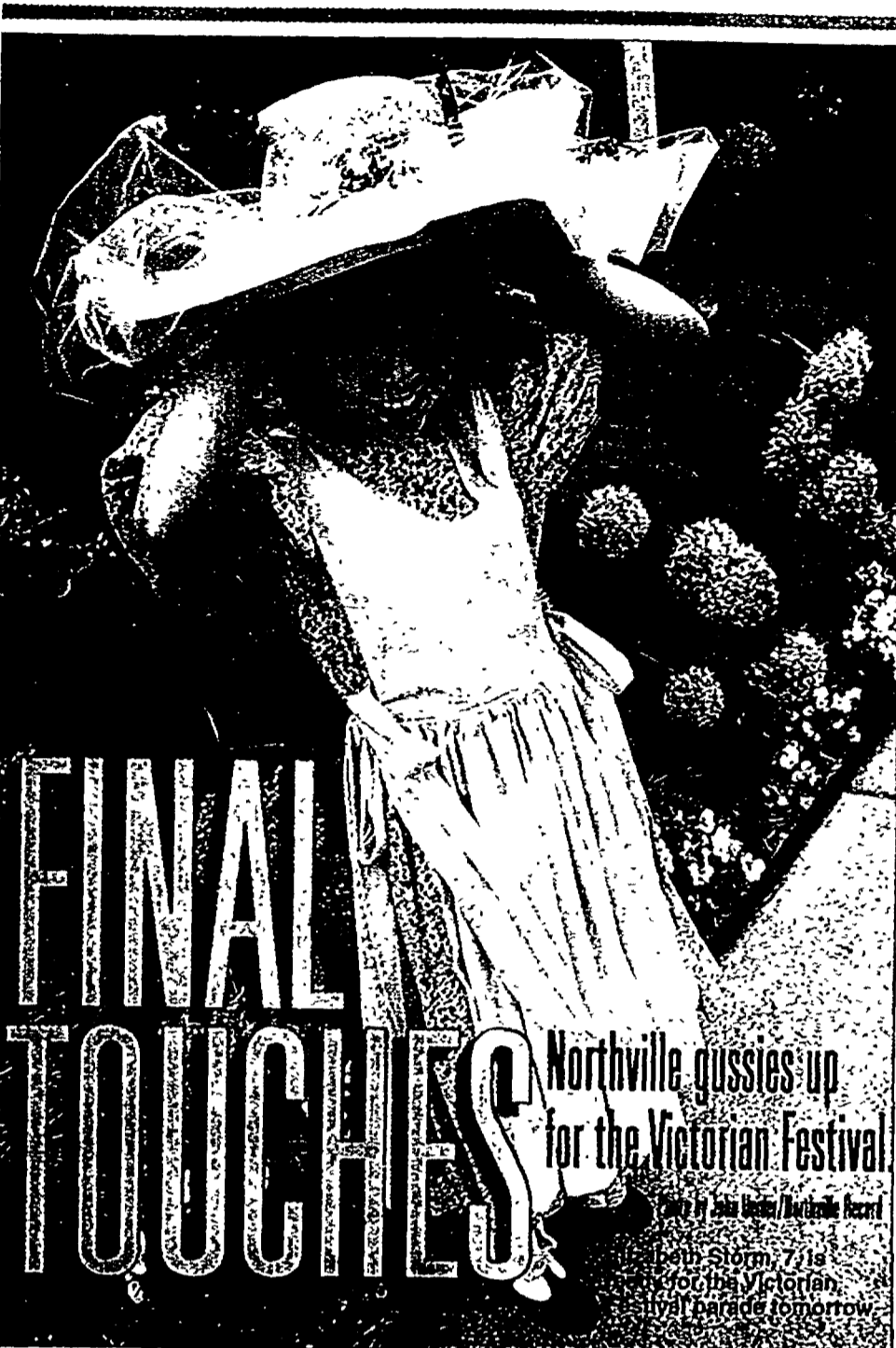

### Community dresses the part for 18th annual stroll into the past

## Victorian Festival

By Maureen Johnston  
RECORD STAFF WRITER

Tomorrow morning, Elizabeth Storm will tie her pinafore, fasten her hat and slip into the 1800s.

The 7-year-old will stroll with 630 Northville community third graders into the world predating iPods and Crocs. The public and private schools' annual field trip casts the tiny historians in the roles of their predecessors, walking them through vintage architecture and coaxing them to simple play during a leisurely lawn lunch.

"When they get downtown — it's just the whole atmosphere," said Elizabeth's mom, Amy, who

"The parents have to dress, too, so I have the whole shebang."

Amy Storm  
Resident, Northville

previously accompanied her sons, Brian and Eric, on the school outing. "They feel like they're in 'Victorian Northville.' " "The best part is when they all have lunch at Mill Race (Historical Village), playing

### Festival Hours:

- Friday: 5-11 p.m.
- Saturday: 11 a.m.-11 p.m.
- Sunday: 11 a.m.-5 p.m.

around the old buildings. That's when you really feel like you stepped back in time."

The morning student promenade officially launches Northville's weekend return to the era of its foundation during the reign of British monarch, Queen Victoria. The rest of the local gentlefolks, adorned in their Victorian finery, will begin trickling into town when the work day ends, before the 6:30 p.m. parade start. City streets originally traversed by horse and carriage will close to vehicles through Sunday evening. Let the bows and curtsies begin.

### Puttin' on the ritz

While the festival host organization, the Northville Chamber of Commerce, has been fluffing the plumes of entertainment and attractions, the Northville

continued on Page 7A

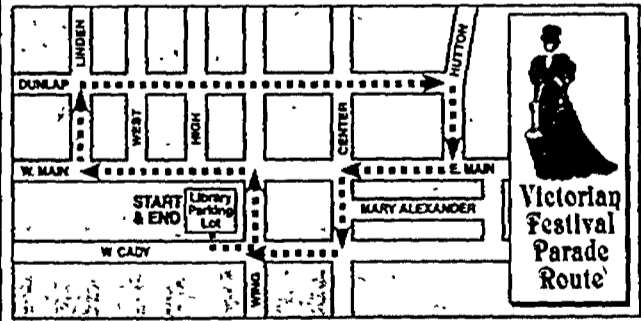

# Teachers: no deal yet

## But educators return to local classrooms anyway

By Victoria Mitchell  
RECORD STAFF WRITER

Contract talks are expected to resume today between the district and Northville Education Association.

Northville Public Schools teachers have been without a contract since Sept. 1 and speculation continues as to whether an agreement will be reached or an extension will be agreed upon by both parties.

"It is an issue being reviewed," said Leonard Reznierski, Northville Public Schools superintendent.

Some progress has been made resulting in the issuance of the 2006-07 school year tentative calendar and change in hours students attend class.

Both sides have agreed to attend two-hour bargaining sessions on September 14, 21, 28 and Oct. 5.

According to the Northville Education Association Web site, the organization has formally submitted a request for a contract extension to the school board.

Although both sides decline to discuss specific sticking points, major issues under discussion include teacher salaries and benefits.

A 2004 settlement for the teacher contract expiring last month included a 1 percent

### Four-titude

Extended Class Days Some Northville students are unhappy about a school day extended by four minutes this year. See why. Page 10A.

### 'Veggin' out

Healthy Choices This year local students have vegetarian options while standing in the lunch line. Page 9A.

salary raise for the first semester of 2004-05; 1 percent salary raise for the second semester of 2004-05; 2 percent salary raise for 2005-06 school year; doubled prescription drug co-pay; longer days; and an earlier start day to the year.

This is not the first time teachers began the year without a permanent contract in place.

The 1998-2004 contract between the association and Northville Public Schools was extended three times before a settlement was reached in the end of November 2004.

Victoria Mitchell can be reached at (248) 349-1700, ext. 122 or vmitchell@gannett.com.

## Two local deaths mark passing of Northville era

### Friends, family mourn Allen, Stubenvoll

By Maureen Johnston  
RECORD STAFF WRITER

Last week, the City of Northville lost two of its founding fathers, Austin Malcolm "Mike" Allen and John Frederick Stubenvoll.

Allen, Northville mayor from 1958-1978, died Sept. 9. He was 91.

Stubenvoll, 87, was a lifelong Northville resident. He died Sept. 6 following a brief battle with cancer.

Both public council members when the city was incorporated in 1955, their legacy was built upon their shared desire to offer residents a full-service, efficiently managed, independent municipality.

"It's sad because they were both fine community citizens," said Bill Sliger, former Northville Record publisher. "They were the last two members of the original city council.



Long-term Northville mayor Mike Allen holds one of his ceremonial gavels in his home office.

"As members of the first council, they had to make a number of recommendations and considerations in the way the city would progress."

Following visitation at the Casterline Funeral Home and church services, both men were interred at Rural Hill Cemetery.

continued on Page 13A

## Autumn dance: Do the mill

### Family operation serves up cider and donuts as annual tradition

By Maureen Johnston  
RECORD STAFF WRITER

A smiling five-year-old Jane Colter curled one hand into her mom's and the other into a bag of spice donuts.

After school last Thursday, the Amerman Elementary School kindergartner and her mother, Julie, enjoyed an afternoon at Parmenter's Northville Cider Mill. They picked a sweet feast to take home and share with brother Zachary, 9, and dad, Brian.

"I think it's a thing families like to do in the fall, visit a cider mill," said mill co-owner Diane Jones.

"It's a nice thing to do — the colors, the sun, it's not too cold."

The mill's family had poured cider for the Colter family, a fall tradition begun by the Parmenters on the site in 1873. For sibling owners Jones and Cheryl Nelson, Labor Day weekend ushered in their 16th season.

Ready to do the mill? Here's some tips:

### Finding it

Tucked off the main drag, Parmenter's sits along the Rouge River, near the spot where Baseline Road

continued on Page 21A



Photo by JOHN HEIDER/Northville Record

Parmenter's employees Mike Jones, left, and Tom Curry sort apples as they begin the cider making process.

**FALLERT** Stay Warm & Cozy with HOT SAVINGS with an ENERGY EFFICIENT Bryant Furnace Call FALLERT 248-437-4385 Your Heating & Cooling Specialists since 1980

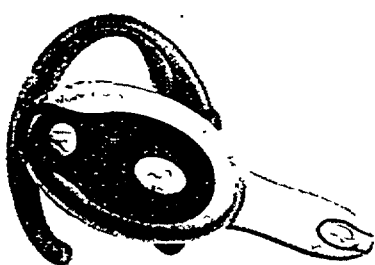
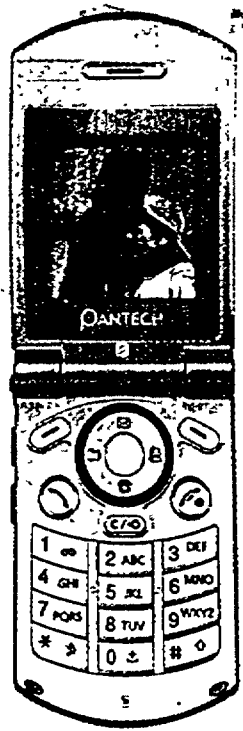
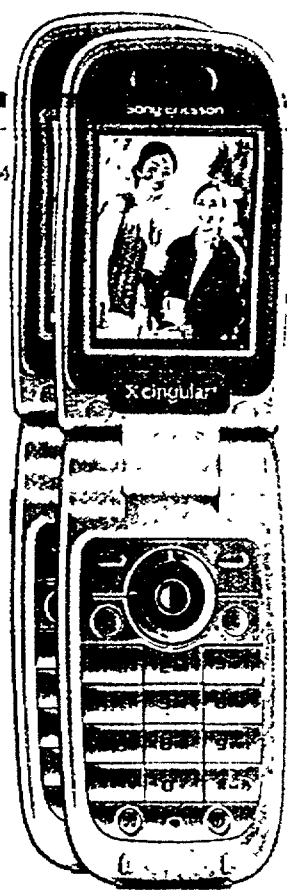
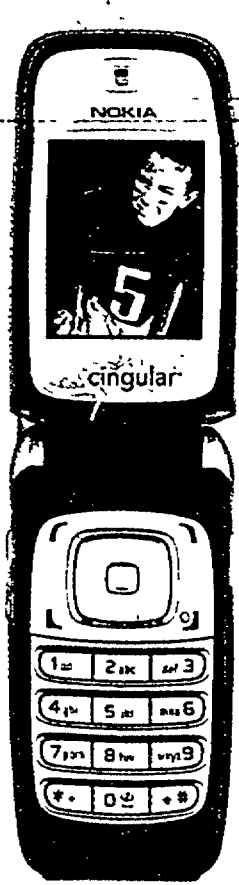

**▶ GET \$50**  
 When you switch to Cingular by trading in your phone from any other wireless carrier.  
\$50 mail-in rebate debit card on new contract and 2-year service agreement.

**▶ FEWEST DROPPED CALLS**  
 Testing from the leading independent research company proves that Cingular has the fewest dropped calls of any wireless carrier.

cingular 

<p><b>Novi 43215 Grand River</b>                  (248) 449-1779†                  Inside Twelve Oaks Mall                  (248) 449-9092†</p>	<p><b>Plymouth 620 Ann Arbor Rd. W</b>                  (734) 451-0720†                  White Lake 9136 Highland Rd.                  (248) 698-0500†</p>	<p><b>Commerce Twp. 140 Commerce Rd.</b>                  (248) 363-2600                  1529 Union Lake Rd., (248) 363-3900</p>	<p><b>New Hudson 30482 Mulford Rd.</b>                  (248) 446-3222                  Northville 1116 W Main                  (248) 343-8116</p>	<p><b>South Lyon 20734 Portac Trail</b>                  (248) 486-7800</p>	<p><b>Westland 47454 Portac Trail</b>                  (248) 668-9898                   †Open Sunday</p>
---	--	---	--	---	--

\*Cingular also imposes monthly a Regulatory Cost Recovery Charge of up to \$1.25 to help defray costs incurred in complying with State and Federal telecom regulations, State and Federal Universal Service charges, and surcharges for customer-based and revenue-based state and local assessments on Cingular. These are not taxes or government-required charges.

Limited-time offer. Other conditions and restrictions apply. See contract and rate plan brochure for details. Subscriber must live and have a mailing address within Cingular's owned network coverage area. Up to \$36 activation fee applies. Equipment price and availability may vary by market and may not be available from independent retailers. Early Termination Fee: None if canceled in the first 30 days, thereafter \$175. Some agents impose additional fees. Sales tax calculated based on price of unactivated equipment. **BlackBerry Card:** Price of Nokia 6102c before \$50 mail-in rebate debit card and data package purchase is \$99.99. Prices of Sony Ericsson 2525a phones before \$40 mail-in rebate debit cards and Push to Talk service agreements are \$99.99 and \$59.99, respectively. Price of Pantech C300 before data package purchase is \$89.99. Price of Motorola HS850 Bluetooth Headset before \$20 mail-in rebate debit card is \$69.99. Allow 10-12 weeks for rebate debit card. Rebate debit card not available at all locations. Must be customer for 30 consecutive days. Must be postmarked by 11/2/06. \*\$9.99 minimum data package purchase required. **Unlimited Price Services:** Unlimited voice services are provided solely for five dialing between two individuals. **Offnet Usage:** If your minutes of use (including unlimited services) on other carriers' networks ("offnet usage") during any two consecutive months exceed your offnet usage allowance, Cingular may at its option terminate your service, deny your continued use of other carriers' coverage, or change your plan to one imposing usage charges for offnet usage. Your offnet usage allowance is equal to the lesser of 750 minutes or 40% of the anytime minutes included with your plan. **Pantech C300:** World's smallest camera flip phone by volume. **Dropped calls claim** is based on nationwide experience among national carriers. **30-day guarantee:** If phone is returned within 30 days in like-new condition with all components, early termination fee will be waived. All other charges apply. ©2006 Cingular Wireless. All rights reserved.



# Hazardous Waste Day offers clean up

By Renee Saunders  
RECORD STAFF WRITER

Melvin and Linda Lestock gladly stockpile hazardous waste. The Northville couple saves the stuff in their garage for a very special day that comes around twice a year: Household Hazardous Waste Day.

"It's amazing how many things we can accumulate," Linda Lestock said, who has lived with her family in Northville for 18 years.

"My husband has some oil, but we're getting ready to move, so we'll probably be delving into the cupboards and the basement looking at what's down there."

As part of an agreement between Northville, Northville Township and Livonia, Household Hazardous Waste Day is held twice per year, in the spring and fall, for city and township residents.

This year's fall event is scheduled from 8 a.m.-4 p.m. Saturday, Sept. 23 at the city of Northville's Department of Public Works yard, 650 Doherty Drive.

Livonia sponsors Household Hazardous Waste Day in the spring and Northville sponsors the event in the fall.

Lestock said she and her husband are moving to Florida, hopefully before the end of fall, because her husband is retiring, so dumping off their waste before the move is a priority.

"We live in a throw-away society, so I am very conscious about what goes back into the environment," she said. "We have to save it for our children, our grandchildren and their children."

James Gallogly, Northville public works director said the city, township and Livonia have worked together for about six years to give residents a convenient way to dispose of their hazardous material.

"It's the best service we offer," Gallogly said. "They get rid of all of their environmental sins in 30 minutes — Saturdays are very important to people."

While its convenient and free for residents and the three municipalities ask everyone to participate, Hazardous Waste Day comes at a cost.

The municipalities are required to pay the contractor about \$33 per vehicle to dispose of the gunk.

Because of the cost, Gallogly suggests Northville city residents talk to their neighbors and try to collect waste from the neighborhood and haul it to the site in one vehicle.

Northville Township residents are not openly encouraged to do

## Time, day, place

Household Hazardous Waste Day is scheduled from 8 a.m. - 4 p.m. at the city of Northville's Department of Public Works yard, 650 Doherty Drive. For more information, call (248) 449-9930.

## What is hazardous waste?

- Aerosol Cans
- Any Household Chemicals
- Automobile/Marine/Household Batteries
- Caustic/Acids
- Computer Equipment
- Fluorescent Light Bulbs
- Gasoline/Gasoline and Oil Mixes
- Herbicides/Pesticides

- Insecticides/Fungicides
- Kerosene
- Modems
- Computers/Electronics
- Medical Waste (sharp items in containers only)
- Mercury Items
- Mercury Contaminated Debris
- Oil Based Paints/Stains
- Primers/Turpentine/Varnishes

- Propane Tanks
- Transmission Fluid/Antifreeze

## What isn't hazardous waste?

- Latex Paint
- Ammunition

the same.

"We encourage all residents to participate and help in protecting the environment: the lakes and the streams," said Jill Rickard, township staff engineer. "We don't want to discourage anyone from coming. We would rather see the material than worry about \$33 a car. It costs more to clean

up pollution.

"But of course, we would like to see savings any chance we get."

Renee Saunders can be reached at (248) 349-1700 ext. 110, or via e-mail at [rsaunders@gannett.com](mailto:rsaunders@gannett.com)



Photo by JOHN HEIDER/Northville Record

Linda Lestock gathers hazardous waste she and her husband, Mel, will dispose of during Northville's Household Hazardous Waste Day on Sept. 23.

THINKING ABOUT...  
**A NEW FURNACE?**

**LENNOX**  
Innovation never let us go!

**FREE ESTIMATES**  
(734) 525-1930

- 0% Financing Available
- 5 Years Parts & Labor Warranty

Our 32nd Year!  
**UNITED TEMPERATURE**  
8919 MIDDLEBELT • LIVONIA

**Jim Seghi Renovations**

**100 FREE**  
Lottery Tickets With Any Renovation of \$5,000 or more!

• Additions  
• Kitchens  
• Bathrooms  
• Decks  
• Basements

248-437-2454  
[www.jimseghirenovations.com](http://www.jimseghirenovations.com)

**45th Anniversary Sale**

**Hardy Mums**  
3/\$10.00

**Jumbo Mums**  
3/\$12

**All Plants, Trees & Evergreens**  
45% off

Spend \$150 and receive an additional 10% off!

**HOLLOW OAK**  
11900 Rushton Rd.  
South Lyon  
248-437-7507

# Chevrolet Specials!

**2007 CHEVY IMPALA LT**

Stk. #6243

**\$121.64\***  
mo.

**2007 TAHOE LT 4x4**

Stk. #16543

**\$310.43\***  
mo.

**2007 CHEVY TRAILBLAZER LS**

Stk. #16554

**\$187.10\***  
mo.

**2007 CHEVY SILVERADO EXT CAB**

Stk. #16436

**\$87\***  
mo.

**2006 CHEVY TRAILBLAZER 4x4**

MSRP \$29,750  
Champion Savings -\$5,500  
Champion Rebate -\$3,350  
Stk. #P2095

**Now! \$20,900**

**2006 CHEVY IMPALA LT**

MSRP \$22,780  
Champion Savings -\$2,720  
Champion Rebate -\$1,600  
Stk. #P2097

**Now! \$18,460**

**2006 CHEVY MALIBU MAXX**

MSRP \$21,090  
Champion Savings -\$2,860  
Champion Rebate -\$2,250  
Stk. #P2197

**Now! \$15,980**

**2006 CHEVY UPLANDER**

MSRP \$25,680  
Champion Savings -\$3,770  
Champion Rebate -\$3,250  
Stk. #P2142

**Now! \$18,660**

**Finance Specialist on Staff**  
**Help For All Credit Situations**  
Toll Free Approval #  
\*\*24 Hours\*\*  
**1-800-680-4362\*\***  
or Call Direct  
**1-888-339-CHEV (2433)**

# Used Specials!

<b>2003-2006 CHEVY IMPALAS</b>  <b>From \$6,900</b>	2002 CHEVY SILVERADO ..... <b>\$12,900</b>	2002 LAND ROVER FREELANDER .. <b>\$11,900</b>
2002 CHEVY S-10 EXT CAB 4x4 .. <b>\$8,900</b>	2002 CHEVY SUBURBAN ..... <b>\$12,900</b>	1998 CHEVY LUMINA ..... <b>\$3,900</b>
2001 GMC SAFARI ..... <b>\$8,800</b>	2004 CHEVY TRAILBLAZER 4x4 .. <b>\$16,900</b>	2003 CHEVY VENTURE ..... <b>\$8,900</b>
2004 SATURN VUE ..... <b>\$13,900</b>	1999 FORD ESCORT ..... <b>\$5,900</b>	2003 CHEVY TRAILBLAZER ... <b>\$11,900</b>
	2001 FORD EXPLORER SPORT .. <b>\$7,900</b>	2002 KIA SPECTRA ..... <b>\$5,900</b>
	2000 JEEP GRAND CHEROKEE .. <b>\$6,900</b>	2001 DODGE GRAND CARAVAN EX .. <b>\$10,900</b>

**C HAMPION**  
**CHEVROLET**

5000 E. Grand River • Brighton/Howell  
I-96 Exit 141 & Grand River  
**TOLL FREE (888) 339-2438**  
**www.champchev.com**

\*Payments based on GMS, plus tax. Total due at signing \$3995.00 with a transfer of plate. Residency restrictions apply. Subject to presale. Vehicles may not be as pictured. GMAC approval required. Closed-end leases, 27 months, 10,000 miles per year. 25c per mile over 10,000 per year. Excess wear and tear provisions apply.

# Mr. Crime Fighter

Northville resident turns FBI, Mafia experience into private crime-fighting career

By Renee Saunders  
STAFF WRITER

Michael Barrett lived a double life.

The Northville Township resident worked for the Mafia.

His resume included money laundering, transferring funds out of the country, insider trading and stock market manipulation, skills which he still uses today working for a fraud deterrent advisory firm in Bloomfield Hills.

His Mafia days were before John Gotti was boss.

Back then, Barrett had a different name, lived in a different state, became engaged and adopted his children.

Or so the Mafia thought.

Barrett did live in a state other than Michigan, but they didn't have his real name and never knew that he was married before he started "working" for them.

They never had a clue that the two daughters he was raising were his own.

And they especially didn't know that Barrett was actually an undercover Federal Bureau of Investigation agent.

"It was sometimes tense," said Barrett, now a divorcee whose daughters have grown. "The trick to it, is that it's not too far from

**"The trick to it, is that it's not too far from your own reality. I walked the walk, I talked the talk."**

**Michael Barrett**  
Former FBI agent

Since retiring from the FBI in 2000, Barrett opened a white-collar crime busting firm, but recently closed his own business to work his new post as senior manager at Cendrowski Corporate Advisors in Bloomfield Hills.

With his previous experience in litigation support, fraud and forensic accounting and white collar crime investigations, Barrett said it makes sense that he now works for a leading accounting and fraud deterrent advisory firm.

"It was a logical progression from working for the FBI for 25 years," Barrett said.

In addition with recently landing a new job, Barrett also was recently appointed by the National Republican Congressional Committee to serve on the Business Advisory Council.

His position is expected to play a crucial role in involving top business people in the process of government reform.

"I've been a public servant most of my life," Barrett said.

Renee Saunders can be reached at (248) 349-1700 ext. 110, or via e-mail at [rsaunders@gannett.com](mailto:rsaunders@gannett.com)



Photo by RENEE SAUNDERS/Northville Record

Michael Barrett was an undercover FBI agent working for the Mafia during the 1980s.

**"It was a logical progression from working for the FBI for 25 years."**

**Michael Barrett**  
Former FBI agent

THE NORTHVILLE RECORD  
Published Each Thursday  
By The Northville Record  
104 W. Main Street  
Northville, Michigan 48167  
Periodical  
At Northville, Michigan

Subscription Rates:  
Inside Counties \$26 one year home delivery. Outside Counties (in Michigan) are \$40 per year, prepaid. Out of state, \$50 per year.

The Northville Record is published by Federated Publications, Inc a wholly owned subsidiary of Gannett Co. Inc. Postmaster, send address changes to: The Northville Record, Post Office Box 470, Howell, MI 48844. POLICY STATEMENT: All advertising published in The Northville Record is subject to the conditions stated in the applicable rate card, copies of which are available from the advertising department, The Northville Record, 104 W. Main Street, Northville, Michigan 48167. (248-349-1700). The Northville Record reserves the right not to accept an advertiser's order. The Northville Record ad-takers have no authority to bind this newspaper and only publication of an advertisement shall constitute final acceptance of the advertiser's order.

Publication Number USPS 3989-20

THE WORLD'S FINEST LADIES' & GENTLEMEN'S CLOTHING

**40% TO 70% OFF**  
**INVENTORY LIQUIDATION**  
**10 DAYS ONLY!**

CANALI • CORNELIANI • VESTIMENTA • HICKEY-FREEMAN

**SUITS** ..... as low as **\$495**

**SPORTCOATS** .... as low as **\$295**

**SPECIAL!**  
LUIGI BIANCHI **SUITS** Regular \$995-\$1295 **NOW \$695**  
Special order sizes available

HICKEY-FREEMAN  
**SUITS & SPORTCOATS**  
**1/2 PRICE**  
Shirts **\$69** or **2 for \$125**

ZANELLA • INCOTEX • BERNARD ZINS  
**TROUSERS 40% OFF**

**SHIRT SPECIALS!**  
CANALI • XACUS • LORENZINI  
Values to \$295 **NOW \$99.95**

**OUTERWEAR JACKETS**  
**50-60-70% OFF**

**LADIES' COLLECTION**  
PIAZZA SEMPIONI  
ZANELLA  
BERNARD ZINS  
**50% 60% 70% OFF!**

**GRAVATI SHOES**  
**40% OFF**

**RENAISSANCE**  
ANN ARBOR

350 SOUTH MAIN  
DOWNTOWN ANN ARBOR  
734-769-8511  
[www.renaissanceannarbor.com](http://www.renaissanceannarbor.com)  
Mon & Tues 11-7 • Wed & Thurs 11-8  
Fri & Sat 11-9 • Sunday 12-5

Exceeding the remodeling expectations of our clients for over 41 years!

**FULL SERVICE REMODELING**



**KITCHENS  
BATHROOMS  
ADDITIONS  
BASEMENTS**

**SIDING  
ROOFS  
WINDOWS  
DECKS**

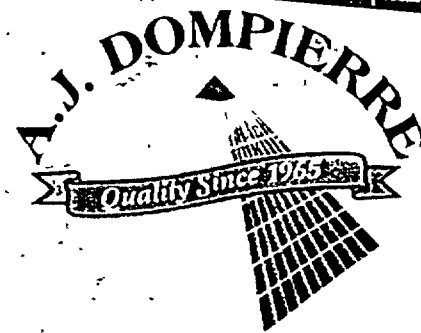

Mention this ad & Save up to \$1000!

CONSTRUCTION

**kitchens**  
BY DOMPIERRE

**248.478.4450**

or visit our newly remodeled showroom at:  
32423 Grand River • Farmington • MI • 48336  
[www.ajdompiereconstruction.com](http://www.ajdompiereconstruction.com)

OE06466857

Circle Money Market™ Account

**4.50%**  
APY

BALANCES OF \$10,000 OR MORE  
WITH CIRCLE CHECKING™

**Charter One**  
Not your typical bank.®

**Liquid Savings. Solid Returns.**

To open an account, visit any of our 124 Michigan branches or call 1-877-TOP-RATE.

# Tell HGTV: What's in those Victorian attics?

Hey, those bartenders look familiar, kind of ... Word is, Laurie and Terry Marrs are going to return from their summer long Petoskey retreat just in time to tend bar at the Victorian Saloon Friday. Stop by the tent behind city hall!

Speaking of the Victorian Festival ... Taking 15 minutes on Sunday could help save a missing child — maybe your own. From 10:30 a.m.-4 p.m., the Michigan Masons are supplying an identification kit, including fingerprints, dental impression and DNA swab, to have handy in the event your child goes missing. They will be set up on Wing Street, south of Main. Fifteen minutes ...

Also this weekend, Orin Jewelers will highlight acclaimed jewelry designer Patricia Daunis' latest collection Saturday and Sunday. Designs of 18- and 14-karat gold and sterling silver — check it out!

Ah yes, the 2006-07 school year is under way. Word from district officials is the first week of school went like a breeze. Despite a few transportation wrinkles, kids, parents, teachers and staff floated through the unofficial start of fall.

He's baaa-aack. Independent producer Jamie Sonderman, son of longtime Northville residents Janet and David Bryant, returned to town last night for his film screening at the Marquis. With a warm welcome, more indie films may follow ...

Got ideas? The folks over at Parks and Recreation are inviting suggestions for services and facilities for the next five years while they update their master plan. It's an informal workshop. Drop in or stay, 4-7 p.m. Tuesday, Sept. 26 at the Northville Township Hall. One thing for sure, keeping the co-ed softball league is key ...

Speaking of projects ... Northville resident Russ Craighead volunteered to help

restore and customize a 1947 Dodge truck into a performance showpiece as part of 94.7 WCSX on-air personalities JJ & Lynne's 2006 Stone Soup Nailhead. The truck will be raffled Sept. 21 to benefit the Children's Leukemia Foundation of Michigan. Want a \$25 ticket? Visit [www.leukemi-michigan.org](http://www.leukemi-michigan.org) or call (248) 353-8222.

Talk about extreme makeovers ... check out the redo going on at the southwest corner of Grace and Eight Mile? Looks like there will be some sore elbows over there ...

Thursday night is sold out, but you might still get a spot Wednesday. With the close of Emily's on Center Street, chef-owner Rick Halberg will host final farewell wine dinners Sept. 20 and 21. Call and see. (248) 349-0505.

What will the bridge look like? That's what the Beal Town folks will be talking about at 6 p.m. Tuesday, Sept. 26, in the city council chambers. The project to reconnect the south side to the rest of downtown is supposed to happen next summer ...

Corn maze with a twist ... that's right, the Maybury Farm maze, opening this weekend, winds through the woods for added excitement. Check it out!

Speaking of excitement ... word is Northville Colony Estates residents spotted a coyote Sunday night prowling backyards along the Country Club Village border. Ah-oooooo.

What about the house where the women fell victim to an icicle, or a tale of some sort? "If Walls Could Talk," the weekly series Sundays on HGTV is coming to Michigan to film homes with intriguing pasts and unusual stories. Homeowners who would like to be considered for the program should contact Keri Grogan at (303) 712-3302 or [kgrogan@highnoonentertainment.com](mailto:kgrogan@highnoonentertainment.com).



Party host Ken Kaestner.



Arbor Mino and Andrew Donnelly.



Lorie and Bob Boshoven.



Novi Street neighbors.



Musician Rennie Kaufman

Heather Donnelly.



Elizabeth Boshoven and

Photos by LESLEY DONNELLY

## Nothin', but a Block Party!

Sunday, Sept. 3 marked the annual Novi Street Block Party. Still going strong after 14 years, the neighbors of Novi Street, between Allen and Langfield, gather for

one last celebration before the beginning of the new school year. The Block Party includes former neighbors, who return annually to reunite and enjoy live entertainment. This year's honored guest was musician Rennie Kaufmann.



## We're going the extra... forty-thousand miles.

At DTE Energy we're going the extra mile for our customers - making our service safer, more efficient and more reliable than ever. Over the next five years, Detroit Edison plans to use infrared scanners and cameras to inspect our entire electrical system, nearly 3,000 circuits and 40 thousand miles of electrical lines. All in all, service to 2.2 million customers will be enhanced. It's part of a 5 billion dollar investment in the communities we serve - for superior service and reliability.

**DTE Energy**



Detroit Edison

[dteenergy.com](http://dteenergy.com)

The Power of Your Community | e=DTE®

### CHARTER TOWNSHIP OF NORTHVILLE NOTICE TO RESIDENTS OF THE CHARTER TOWNSHIP OF NORTHVILLE

There will be a PUBLIC HEARING on the budget for the fiscal year January 1, 2007 through December 31, 2007 at the Northville Township Municipal Offices, 44405 Six Mile Rd., Northville, MI 48168 at 7:30 p.m. September 21, 2006.

All interested residents are invited to attend. Comments and questions concerning the proposed budget will be heard at the public hearing.

A copy of the proposed budget will be available for public inspection at the Township Clerk's office beginning September 11, 2006 between the hours of 9:00 a.m. and 4:00 p.m.

The property tax millage rate proposed to be levied to support the proposed budget will be a subject of this hearing.

(9-7/14-06 NR 308193) SUE A HILLEBRAND, CLERK

### CHARTER TOWNSHIP OF NORTHVILLE NOTICE OF PUBLIC HEARING

Pursuant to Act No. 198 of Public Acts of 1974, as amended, the Charter Township of Northville has authorization to establish an Industrial Development District in order to permit local industries to obtain exemption from certain real and personal property tax, for a period of years; and WHEREAS, the Charter Township of Northville seeks to improve the marketability of the Northville Technology Park by creating Industrial Development District # 5 to encompass its legal boundaries.

NOW THEREFORE BE IT RESOLVED, that the Charter Township of Northville, Board of Trustees hereby gives NOTICE OF A PUBLIC HEARING to be held on Thursday, September 21 at 7:30 p.m. Charter Township of Northville Township Hall, Board of Trustees Chambers, 44405 Six Mile Road, Northville, Michigan 48168.

Any owner, resident, or taxpayer may appear at said Hearing and give testimony.

The location of said premises to be considered as an Industrial Development District is described as: Property Identification Numbers - 8277-063-99-0002-726, 8277-063-99-0002-724, 8277-063-99-0002-722, 8277-063-99-0002-720.

Said property is as shown on the map below.

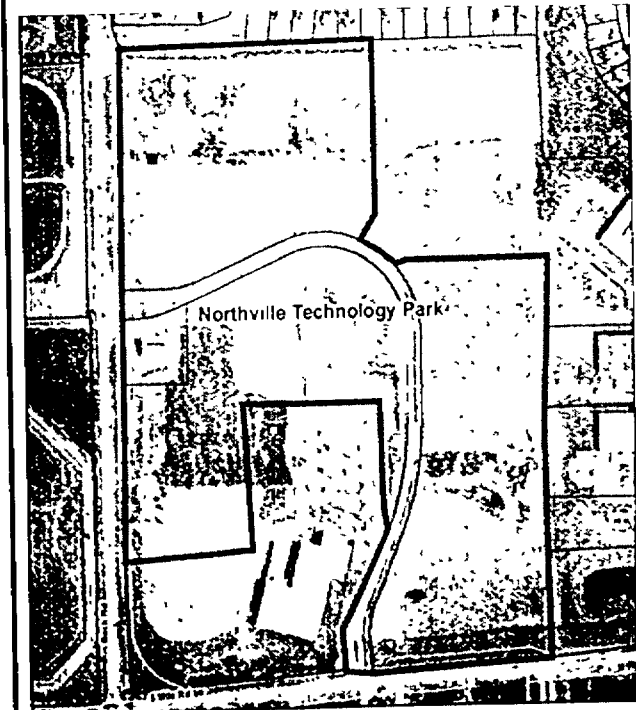

Site location map and complete legal descriptions of all affected parcels is available at the Clerk's office.

SUE HILLEBRAND, CMC TOWNSHIP CLERK

(9-7/14-06 NR 308641)

## POLICE BRIEFS

## Larceny

A 68-year-old man reported priceless treasures were taken from his home on the 4400 block of Country Lane during the summer.

He told police that two months ago he began to notice items of value missing from his home when his daughter asked for his saved Beetle albums and original collector Clue game. He originally thought the items had been misplaced. In mid-August, he noticed his antique collection of ancient Egyptian, Roman and Greek, dated as far back as 650 A.D. were missing from his vault located inside his home. At the same time, he noticed a Jim dynasty pot missing from its place in the living area. He told police four to five days before he made the Sept. 3 police report, he noticed his Tang dynasty gold goblet, circa 750 A.D., was also missing and provided police with a picture of the item. He told police his wife and children could not have taken the items. The case is open.

## Stolen vehicle

A 76-year-old man living on the 1900 block of Surrey Lane reported his 1996 Lumina was missing from its usual parking space Saturday, Sept. 2. Six of the van's seats were recovered near a dumpster, according to the police report and two other vehicles in that area had their tires stolen. The case is open.

## Civil matter

A 55-year-old woman and her 66-year-old husband visited the police station because their neighbor, a 75-year-old woman repeatedly asked them to trim the bushes along their

driveway. The woman who reported the incident told police she had no intentions of trimming the bushes, so her neighbor allegedly hired a man to cut them, despite her wishes. When contacted by police, the neighbor told the officer her now deceased husband planted the bushes, they were her property and Northville Township building department officials were coming to verify the property lines located on the 18000 block of Larugh Drive. The officer asked the neighbor not to touch the bushes until the property dispute is handled. The case is closed.

## Just too fast

A Roscommon man faces a Sept. 21 court date on drunk driving charges after an arrest by Northville police last Friday.

Police reports indicated officers stopped the white Ford pickup driver after he was allegedly traveling 53 mph on Eight Mile Road, near Novi Road. Preliminary breath tests indicated the man's blood alcohol content was .14, above the state's .08 legal limit, the report said.

After arresting the man for operating a vehicle while intoxicated, officers transported him to the Northville Township police station where he was held pending bond.

## Home invasion

On Sept. 5, Northville police were dispatched to a home in the 300 block of Hill Street after the homeowner's daughter discovered apparent evidence of a burglary attempt.

According to police reports, the 25-year-old woman told officers nothing appeared to be missing

from the garage, one of the attempted areas of entry. Police reports documented cut screens, a broken window and prymarks where the suspect apparently tried to enter the home from the attached garage.

The woman reported someone rang the doorbell at about 1:30 a.m. the day she discovered the damage, but she did not respond. Officers speculated it could have been the suspect checking to see if the home was occupied.

Police reports indicated neighbors did not witness any suspects. The investigation remains open.

## Busy intersection

Twenty four hours apart, Northville police arrested two women at the same location for drunk driving after initially stopping them for an illegal right turn on a red signal.

Police reports indicated a 28-year-old Westland woman driving a black Taurus was stopped last Friday near the intersection of Eight Mile and Novi roads. She was arrested for drunk driving after a preliminary breath test indicated a .142 blood alcohol level, above the state's .08 legal limit. She was transported to the Northville Township police station, where she was assigned a Sept. 18 court date and held pending bond.

On Saturday, a 30-year-old Commerce Township woman driving a red Pontiac was arrested for drunk driving at Novi and Eight Mile roads after a preliminary breath test indicated her blood alcohol content was .147, reports said. She was transported to the township station, where she was assigned a Sept. 21 court date and held pending bond.

## MEETING NOTEBOOK: SCHOOLS

## Sept. 12 Meeting

All members were present  
Next Meeting: Sept. 26

## New teacher hires

Board members unanimously approved probationary teacher contracts for the 2006-07 school year. As of Sept. 7, 26 certified staff members were hired. There are four certified positions remaining.

## Year-end report

District administrators reviewed the Northville Public Schools 2005-06 year-end report Tuesday night, detailing district challenges. Points included the success of two elections and failure of one; tragic losses of Tim Turner and Hannah Rose Doody; exceeding academic benchmarks; legislative recognition of the district's IST program; and fiscal hardships and successes, including an unqualified audit report and refunding bond issue.

## Summer school

Northville Public Schools Summer School Principal Bob Boshoven presented the 2006 final report Tuesday to members of the Board. He said the program participation grew 61 percent from 2004. The summer school staff also increased this year with the addition of elementary school offerings, two biology courses and the student

increase. Boshoven said the program was profitable, returning \$38,479 dollars to the district.

## Superintendent evaluation

Board members unanimously approved the 2005-06 superintendent's evaluation report. Superintendent Leonard Rezmierski was favorably reviewed in the categories of goals, management of district departments, community relations, personal qualities and board relationships. A new format was used this year, the first change in 15 years.

## Textbook approval

Board members unanimously approved the district's suggested Sixth Grade Math Pilot Textbook program. The approval includes 450 sixth-grade regular and 120 advanced math books.

## Board policies

Unanimous support was given by the board, approving the following district policies for reaffirmation: Use of buildings and properties; citizen comment at school board meetings; fund balance; and special recognition.

## Sanitary sewer

The Board unanimously approved a sanitary sewer easement/sewerage lift

station agreement on the Northville Public Schools-owned Garfield and Eight Mile roads property. The approval grants the City of Novi a non-exclusive, perpetual easement for sanitary sewer on the southwest portion of the property. Officials said the decision will save the district about \$50,000 in future development costs if they decide to build on the property.

## Cablecast

The Northville Public Schools Board of Education meeting will be available to Comcast subscribers 9 p.m. Monday, Sept. 18 on channel 18.

## Special meeting

The Board of Education will hold a special study session meeting looking at future growth 7 p.m. Tuesday, Sept. 19. The meeting is open to the public.

## OBITUARIES

## PAUL E. EAGAN

Age 94, died August 29, 2006 at Baptist Manor in Farmington Hills, Michigan. Mr. Eagan retired in 1974 as a design engineer with Ford Motor Car Company after 22 years of service. Memorial services were held at the First Baptist Church of Northville on Saturday, September 9, 2006. Mr. Eagan is survived by four children, Joyce Campbell, Donald (Janet) Eagan, Marjorie Julien and Marilyn (Robert) Rowan; thirteen grandchildren and eight great-grandchildren. Memorial contributions to Gideon's International, 37625 Thimbark, Wayne, MI 48184 would be appreciated. Arrangements by Northrop-Sassaman Funeral Home.

## JANET H MILLER

Age 81, died September 1, 2006 at her residence in Northville. Mrs. Miller was a homemaker. Funeral services were held at the Northrop-Sassaman Funeral home on September 5, 2006. Interment was in Rural Hill Cemetery. Mrs. Miller is survived by three children, Robert W. Miller, Judith (Vincent) Amatangelo and Douglas (Peggy) Miller. And six grandchildren, Kelly & Jessie Miller, Katie & Matt Amatangelo and Andrew & Eric Miller. Memorial to the American Heart Association would be appreciated. Arrangements by Northrop-Sassaman Funeral Home.

## MARIE E. DURHAM

Age 90, died September 2, 2006 at South Lyons Gardens Nursing & Rehabilitation. She was a 30 year resident of Northville prior to her death. She owned and operated a general store prior to her retirement. Services for Mrs. Durham were private at the First United Methodist Church of Northville. Mrs. Durham is survived by two daughters, Dolores (late Jerry) Swaton and Sharon (Joe) Lineman. Four grandchildren and nine great grandchildren. Memorial contributions to the cancer research fund of your choice would be appreciated. Arrangements by Northrop-Sassaman Funeral Home.



AUSTIN MALCOLM "MIKE" ALLEN

Age 91, a resident of Northville since 1937, passed away peacefully on September 9, 2006. He was born October 3, 1914 in Whitewater, Missouri to Ossie B. and Azzie (Austin) Allen. He was united in marriage to Inga H. Allen until her death on June 4, 1974. He married Betty J. Allen on August 28, 1976 and they recently celebrated their 30 year anniversary. Mr. Allen began as a designer and builder of monuments in Flint, he then founded Allen Monument Company in Milford, and expanded to Northville in 1937. He owned and operated Allen Monuments from 1937-1995 and was a member of the Michigan Monument Builders. Mr. Allen was devoted to Northville. He was on the city council before serving as Mayor from 1958-1977. He was the Citizen of the Year for the Northville Chamber of Commerce in 1977. Mr. Allen was honored when Allen Terrace was named after him. He was a member of the Rotary Club in Northville for 35 years. He was a member of the Northville Masonic Lodge 186, the Plymouth Elks Lodge 1780, the First Presbyterian Church of Northville, the Northville Historical Society, the Republican Party, and served as an officer for the Northville Driving Club. He worked with the "Stone Gang", which is a volunteer group that makes repairs the Mill Race Village. Mr. Allen enjoyed traveling, gardening, and carpentry; especially building bird houses and toast tongs. He is survived by his wife Betty J. Allen; his children, Jim (Pat) Allen and Sharon Allen; his step-daughter Patricia Hoffman; his siblings, Doris Cheadle, Naomi Jones, Jerome Allen, Flora Johnson, and Hoy (Dorothy) Allen; his grandchildren Scott Allen and Shari Allen; and his great grandchildren Heather Allen (Ryan Buckthorpe), Nicole Allen, and Justin Allen. In addition to his parents and his wife Inga, he was preceded in death by 3 brothers, Ossie Allen Jr., Finney Allen, and Robert Allen, and a sister, Marie Zymda. A funeral service was held Wednesday at the First Presbyterian Church of Northville. Rev. Kent Clise and Rev. James Russell officiated the service. Mr. Allen was laid to rest at Rural Hill Cemetery in Northville. Memorials to the First Presbyterian Church, 200 E. Main St., Northville, MI 48167, the Northville Historical Society, 215 Griswold Ave., Northville, MI 48167, or Allen Terrace, 401 High St., Northville, MI 48167. Arrangements entrusted to Casterline Funeral Home, Inc.

## JOHN FREDERICK STUBENVOLL

Age 87, a lifelong resident of Northville, died peacefully in Marywood Nursing Care Center on September 6, 2006 following a brief battle with cancer. He was born October 11, 1918 in Detroit, Michigan to Frederick W. Stubenvoll and Alice Victoria Wall. He graduated from Northville High School in the Class of 1936. John attended one year at Lawrence Tech. He served in the U.S. Army in the Military Police during WWII and was stationed in Brisbane, Australia and Manila, Philippines. He obtained the rank of Master Sergeant. On August 17, 1946 he was united in marriage to Juanita Irene Elkington in Northville, until her death in August, 1984. He married Ruth Esther Stroh in May 1985, until her death in January, 2005. John began working as a bank teller for the Depositors State Bank of Northville which later merged with Manufacturers Bank. He worked in various branches and was promoted to Vice President. He received a degree in banking from the Stonier Graduate School of Banking affiliated with Rutgers University in 1961. He retired in 1976. John served as a member of the Northville City Council until 1957. He was actively involved in the incorporation of Northville from a village to a city in 1955. He was a member of the First United Methodist Church of Northville. He enjoyed traveling and visiting with family and friends. He is survived by his children, Kyle (Edward) Redente of Colorado and Jane Stubenvoll of Colorado; his granddaughters Elizabeth Redente, Kate Redente and Jessica Redente all of Colorado; and by many nieces, nephews and friends. In addition to his parents and wives he was preceded in death by 5 brothers, Wilbur, Melvin, & Frederick Stubenvoll, Ray & Edward Armstrong, and a sister, Erma Armstrong Durham and a granddaughter Jennifer Redente. A funeral service was held last Saturday at Casterline Funeral Home, Inc. 122 W. Dunlap, Northville. Rev. Lisa "Cook" with the First United Methodist Church officiated the service. Mr. Stubenvoll was laid to rest at Rural Hill Cemetery in Northville. Memorials to the American Cancer Society, 18505 W 12 Mile Rd., Southfield, MI 48076 or to Angela Hospice, 14100 Newburgh Rd., Livonia, MI 48154-5010

## OBITUARY POLICY

The first seven lines of an obituary are published free of charge. After that, there is a fee of \$3 a line. Pictures may be published for \$25.

\*Deadline for obituaries is Tuesday at 10:00 a.m. for publication in Thursday's newspaper.

For more information, call 888-999-1288, or contact your funeral home.

\*Holiday deadlines are subject to change.



## USE OXYGEN?

Imagine No Refills & No Tanks Ever Again!

At less than 5 lbs. the Freestyle by Airsep is the only portable oxygen concentrator specifically designed for those who know no boundaries. Freestyle captures the heart of what it means to live the good life—without limitation. This portable concentrator offers the same weight advantages of tanks & liquid oxygen, yet provides an unlimited supply of oxygen. With the Freestyle you can attend an all day sporting event or wedding. You can even go on a boat trip or even a cruise without worrying about running out of oxygen. The Freestyle's battery lasts longer than any other on the market today.

Depending on liter flow you can get up to 13.5 hours of freedom. Plus the battery can be charged while in use with ac/dc power.

Free Style



## The Portability Experts

## Harbor Oxygen

Home Respiratory Equipment  
Call for your FREE 1-2 day trial!

Phone (248) 446-6114 • Fax (248) 446-6115  
29454 Haas Rd. • Wixom, MI 48393  
Shancoebartell@msa.com

## Searching for the Right Mortgage?

Look no further.

Our first time buyer program is just one of many options.

5.25% Rate

7.613% APR\*

3 Year Adjustable Rate Mortgage with 0 points

The 5.25% rate is as of 9/1/2006 and subject to change. The corresponding Annual Percentage Rate (APR) is 7.613%. The rate is guaranteed for 3 years then subject to change with a 1% annual cap and 5% maximum. The monthly principal and interest payments on a \$200,000 home with 3% down and no points would be \$1,066.34. Loan term 30 years.

Refinance now and lock in this great rate for 5 years!

5.99% Rate

7.131% APR\*

5 Year Adjustable Rate Mortgage with 0 points

The 5.99% rate is as of 9/1/2006 and subject to change. The corresponding Annual Percentage Rate (APR) is 7.131%. The rate is guaranteed for 5 years then subject to change with a 2% annual cap and 6% maximum. The monthly principal and interest payments on a \$250,000 home with 20% down and no points would be \$1,197.82. Loan term 30 years.

Call today and talk to a local mortgage expert. We offer low rates, a variety of mortgage programs and the personal service you expect from Community Financial. Plus, you'll receive a no-cost, no-obligation mortgage analysis designed to help you understand your options.



COMMUNITY FINANCIAL  
MORTGAGE SERVICES

(734) 582-8500

(877) 937-2328 ext. 8500 toll free

www.cfu.org

All loans are subject to approval. This is not an offer for financing, each applicant must submit a complete application and required credit documentation. Proof of homeowners insurance and tax escrow required. Equal Housing Lender. ©2006 Community Financial

# VICTORIAN: Northville ready for annual festival

continued from 1A

Department of Public Works has been spit-shining the city's shoes.

"We'll try to make the city look it's best," said public works director Jim Gallogly, adding city workers this week pulled weeds and added wood chips to islands in city-owned parking lots.

Two weeks ago, public works crews hung the trademark lavender banners on the lightpoles. Last week, they striped parking spaces along downtown side-streets and on the expanded lot behind the Marquis Theatre.

Gallogly said six new trees were planted downtown this week, just in time for the festival. Behind the scenes, city and chamber representatives have coordinated logistics for set-up, power, operations and clean-up.

"This is Northville's largest community event and really a chance for us to shine," said Janet Bloom, chamber marketing and events coordinator. "We expect a wonderful turnout."

## Dressing the part

The sight of gingham dresses, knickers, caps and suspenders mingling on downtown side-walks will remind spectators to allow time for their own trip home to primp. Residents flock to the parade procession to flaunt their authentic and reproduction ascots and bustles.

The 100-year step backward commences with the 1 p.m. Friday close of Main and Center

streets when non-profit organizations dress up their booths, children's rides are unwrapped and antiques come out of closets.

The chamber hired professional entertainers to perform on stage and stroll throughout downtown tomorrow, Saturday and Sunday. The Northville Arts Commission invited artists to exhibit on east Main Street from Center to Hutton streets during its annual Arts Market.

Other events hosted in coordination with the festival are a historic home tour, a parlor tea, a breakfast tea, vintage baseball games, art exhibit, antique market, Victorian saloon, dog competition and antique car show.

## Fashion tradition

Elizabeth Storm said she is looking forward to her walk back in time tomorrow, with her classmates and during the evening parade.

This summer, her Victorian experience began with selecting a dress from the array previously worn by her friend's older sisters during the festival's 18-year

**Art Market**  
Located on E. Main Street  
Presented by Northville Arts Commission  
10am - 7:30pm Saturday  
11am - 5pm Sunday  
Art Market is one of the premier features of the Victorian Festival and adds a modern twist to the Victorian Era environment.

**Art House**  
Located on Cady Street  
Presented by Northville Arts Commission  
4:30 - 8:30pm Friday  
9:30am - 5pm Saturday  
11am - 5pm Sunday  
Camera Club Photography Show  
A guided tour of the club's favorite 2006 images.

history. "That's the way a lot of us get the costumes, hand-me-downs," said Amy Storm, who will accompany Amerman elementary teacher Marilyn Kowalkowski's class downtown tomorrow. "The parents have to dress, too, so I have the whole shebang."

From her wide-brim hat to her low-heeled shoes, Elizabeth is looking forward to donning her ensemble when she awakens tomorrow.

"I'll be thinking how fun it will be."

Maureen Johnston can be reached at (248) 349-1700, ext. 103, or via e-mail at mjohnston@gannett.com.



Photo by JOHN HEIDER/Northville Record

Is Maggie May a shoo-in for cutest dog? Susan Newman will find out this weekend when she enters her five-pound Yorkie Shihtzu in the Northville Parks and Recreation Department's new Great Dog Expedition at 10 a.m. Saturday on Ford Field.

"This is Northville's largest community event and really a chance for us to shine."

Janet Bloom

Marketing and Events Coordinator, Northville Chamber of Commerce

## Historical Home Tour

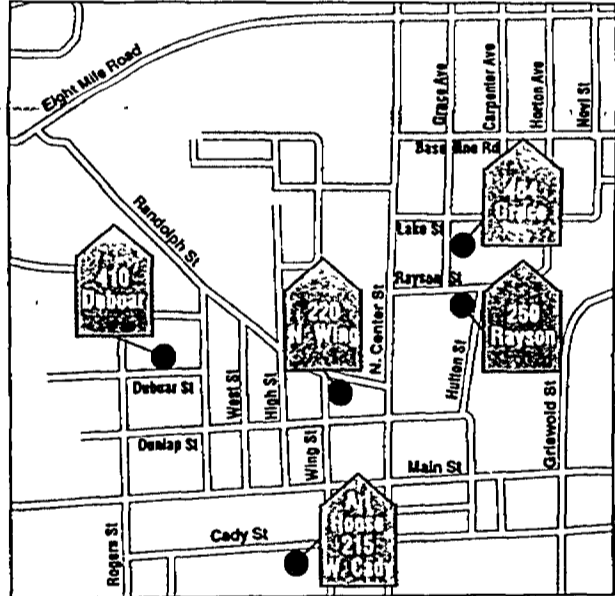

SOURCE: American Association of University Women

# Historical Home Tour slated for Saturday

## Home Tour Rules

- Homes may be visited in any order.
- No shoes or bare feet are permitted in the homes. Socks may be worn or booties provided at the door must be worn.
- No smoking, eating, or drinking in the homes.
- Children under 12 (including infants) and pets are not allowed on the tour.

5. Interior photographs are not permitted.

## 2006 Historical Home Tour

- Maynard Home, 410 Dubuque St.
- Suchomel Home, 220 N. Wing St.
- Fielden Home, 250 Rayson St.
- Gardner Home, 464 Grace St.

- Art House, 215 W. Cady St.

## Tickets available:

- Northville Chamber of Commerce, 195 S. Main
  - Gardenviews, 202 W. Main
  - Petite Maison, 103 E. Main
  - Pear-Aphernalia, 184 E. Main
  - Cozy Café in Plymouth
  - At ALL home tour homes
- the day of the tour  
Cost: \$15

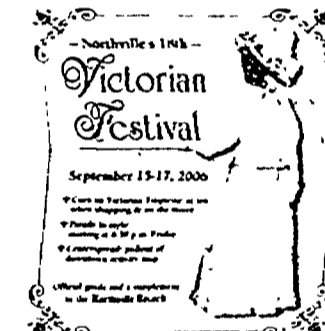

## INSIDE SCOOP

If you want to know what's happening, and when, during this year's Victorian Festival, pick up a free copy of the official event guide at Main and Center streets. Chamber staff members will distribute the Victorian Festival supplement published Sept. 7 by the Northville Record, containing event schedules and locations.

# Final touches for a complete Victorian Festival experience

## A slight detour

Whether or not you're planning to attend the festival, your drive through downtown will be affected this weekend. While the school children are out from 9 a.m.-1 p.m., Main Street, from Rogers Street to Wing Street, will be closed.

From 1 p.m. Friday until 7 p.m. Sunday, central downtown will be closed to vehicles, with the exception of traffic exiting Mary Alexander Court west, turning south onto Center Street. Main Street from Wing to Hutton, and Center Street from Dunlap to Cady will be closed through the festival.

## You're already dressed ...

The chamber still is seeking volunteers to help children playing in Ryde Park on west Main Street. To sign up for a shift tomorrow, Saturday or Sunday, call (248) 349-7640.

Want to help with the parade tomorrow? To help keep people on the sidewalk, call parade organizer Donna Pallas at (248) 348-3767.

## For the carriage ...

Newly painted stripes on Wing, Cady, Griswold and S. Center streets will boost the number of parking slots available to festival visitors.

"There was already parking there, it was just kind of sloppy,"

said public works director Jim Gallogly. "We made it more efficient by striping it."

"Everyone's got 22 feet, which is similar to Main Street."

Also, paving the recently demolished Edward's Catering site on Cady Street added 37 spaces, including three on-street slots.

## Get the details

At a booth in the intersection of Main and Center streets, chamber staff members will distribute the

Victorian Festival supplement published Sept. 7 by the Northville Record, containing entertainment schedules and locations.

## Newly in fashion

- Look for the Antique Market in the American Legion building at the corner of Center and Dunlap streets. New at this location, vendors rented indoor booths to exhibit regardless of weather.
- South of Main Street, vintage vehicles will be lined up on the

east and west sides of south Center Street.

At 10 a.m. Saturday, the Northville Parks and Recreation Department is hosting its inaugural Great Dog Expedition at Ford Field, including contests for owner/dog look-a-like, best Victorian dog costume, best trick, biggest dog, smallest dog and cutest dog.

"Free" couldn't last forever. The wildly popular duck race, held at Mill Race Historical Village at 3 p.m. Sunday, now costs \$5 per duck to enter. The money will be used to erect the general store. It was grounded before it took off. Chamber plans to offer tethered hot-air balloon rides were cancelled for insurance reasons, too late to omit them from promotional literature.

## No longer the fashion

The ladies and gentlemen looking for the saloon Friday and Saturday night need to steer clear of last year's site on the Mary Alexander parking deck. This year, "Dirty Mary's Saloon" will be located behind Northville City Hall, near the corner of Wing and Cady streets. Wristbands will be granted to visitors age 21 and older.

The bids are off on Sunday morning. The box lunch auction, historically hosted by the local council of parent-teacher associations, is expected to return in a new format in 2007.

## Properly helpful

Festival visitors who have a medical emergency have two places to turn for help. Police and fire emergency assistance personnel will be stationed on Mary Alexander Court, near the parking deck entrance. Main Street Family Medicine, on Main Street just east of Hutton, will again provide a first aid station 10 a.m.-8 p.m. Saturday and 11 a.m.-5 p.m. Sunday.

## And also ...

Tickets still are available for

- associated events:
- AAUW Historical Home Tour, 10 a.m.-4 p.m. Saturday. Tickets available at Gardenviews, Petite Maison, Pear-aphernalia and all homes tour day.
  - Victorian Fashion Show and Parlor Tea, 2 p.m. and 3:30 p.m. Saturday, First Presbyterian Church. For information, call (248) 349-0911.
  - A Victorian Portrait — Breakfast Tea, 9:30 a.m. Saturday, Meadowbrook Country Club. For information, (248) 982-7489.

# Parents, do your homework: paperwork deadlines loom

*Kids aren't the only ones with schoolwork*

By Victoria Mitchell  
RECORD STAFF WRITER

It sits in front of you, teasing you like an unfinished term paper — back-to-school paperwork.

Form after form falls out of elementary school backpacks, waiting for parental signatures.

"That first night is like we have homework," said Diane Maier, Moraine Elementary School parent.

The task of signing and returning each form may seem daunting at first, but voices around the district say hang in there and return important Northville Public Schools documents.

### First things first

Administrative Assistant Pat Mogridge is the gatekeeper for some of the most important

forms at Silver Springs Elementary School.

Topping her list of "must haves" is an information card detailing who is authorized to retrieve students from school.

"It's for their child's protection," she said.

Mogridge said the card also avoids unnecessary embarrassment because no child will be let out of the building without the card, even if there is an obvious relationship.

Other forms like emergency dismissal forms are held by teachers, she said.

Reminders sent from all district schools for tardy beginning-of-the-year paperwork will start going out soon to those who haven't complied.

Mogridge said most Silver Springs' parents follow through quickly. She anticipates the

majority of requested forms will be signed and turned in by tomorrow.

"Getting those cards in are very important," she said.

### The rest will follow

As a mother, Maier wades through the first big paperwork envelope of the year like all other parents. As president of the Moraine Elementary School PTA she is also partly responsible for including forms into the mix.

PTA membership forms are part of the pile of documents ranging from medical emergency forms to family outings and the Victorian Festival.

Maier said she thought holding back the parent organization forms in the first rush of information, but decided the timing was fine.

"Parents can go through the forms at their leisure," she said. "And plus, we're excited to get

that info out, too."

Maier's advice is stick with the important cards first, followed by the less pressing information.

"The really important forms are the medical cards and emergency forms," she said.

Maier said Moraine has a pretty high rate of return and most PTA forms will be returned this month.

### And follow

Nearly two weeks into the school year, deadlines are fast approaching for turning in forms.

Checking children's backpacks, Monday envelopes and back seats of cars is good advice to keep up with the game.

After all necessary forms are completed, then wade through the fun information like trips to Whalers games.

And don't forget the PTA, Maier said. "I think being a member



Photo Illustration: GANNETT NEWS SERVICE

makes you more of a part of your school's community," she said.

Victoria Mitchell can be reached at (248) 349-1700, ext. 122 or vmitchell@gannett.com.

### ■ Props for the PTA

Moraine Elementary School PTA President Diane Maier urges parents to fill out their membership forms.

"It's important to be a member of the PTA at any school," she said. "It gives you a vote."

Voting is a member benefit, along with the opportunity to chair a school-related committee.

At Moraine Elementary School the fee is \$5 for a single family or \$10 for a family membership. All family members receive a student directory. Maier said PTA membership dues also proved access to state and national resources. She said although the enrollment forms went out last week, membership is offered throughout the year.

You do not have to be a PTA member to attend regular meetings in the district.

**CANTON CINEMA**  
Goodrich www.crcm.com  
**QUALITY THEATERS** 734-844-FILM  
Ford Rd 1 Mile West of I-275  
All Stadium Seating All Digital Sound  
No passes Free drink refills & 25¢ corn on the cob

**FULLY REMODELED**  
ALL DIGITAL SOUND-ALL LOUNGER SEATS  
ALL STADIUM SEATING

**DETROIT'S BEST MOVIE DEAL BARGAIN PRICES**

**\$6.00** Adults Evening  
**\$5.00** Students, Late Show, Seniors, 65+ (All Shows 6-8 PM)  
**\$4.00** Kids, Seniors, 65+ (All Shows 4-6 PM)

**STUDENTS 2 FOR TUESDAY**  
Buy 1 ticket, get one free

**FREE FALL MATINEES FOR EVERYONE**  
Saturday & Sunday 10 & 11 AM  
WALLACE AND GROMIT (G)

(\*) = SAT/SUN ONLY  
SHOWTIMES VALID 9/15 - 9/21

GRIDIRON GEMS (PG-13)  
12:00 2:30 5:00 7:30 10:00  
EVERYONE'S HERO (G) (11 15) 1 15 15 5 15 7 15 9 15 FRI/SAT LS 11 15  
THE BLACK DANGLA (R)  
12:00 2:25 4:55 7:25 9:55  
THE COVENANT (PG-13) 12:50 3:00 5:10 7:20 9:30 FRI/SAT LS 11:40  
WICKER MAN (PG-13) 7:10 9:25 FRI/SAT LS 11:45  
CRANK (R) 1:45 3:45 5:45 7:45 9:45 FRI/SAT LS 11:45  
INVINCIBLE (PG) 12:30 2:45 5:00 7:15 9:30 FRI/SAT LS 11:45  
BARKYARD (PG) (11 10) 1 10 3:10 5:10

**COUPON**  
**FREE 20oz DRINK**  
on \$2.50 purchase of 100¢ bag of butter popcorn

## FIND YOUR PATH.

Searching for your path in life? Come to a new evening worship service that has been made just for you.

**Share the journey.**

Open hearts. Open minds. Open doors.  
**Northville First United Methodist Church**  
777 W. Eight Mile Road, Northville, MI 48167  
Sunday Morning Worship Services at 8:00, 9:15 and 11:00 AM  
5 PM Evening Worship Service starting on September 17, 2006

# Could \$2 billion help your business get started?

# Then let's go.

Thanks to the Michigan Economic Development Corporation, businesses have access to the \$2 billion 21st Century Jobs Fund. This is the single, biggest financial commitment in the country to support the 21st century economy. Hundreds of businesses from around the world applied. And now the first-round winners have been selected! The winning proposals may use the money to establish, grow or move their business to Michigan. Visit michigan.org to see all the ways Michigan helps businesses find success. And to see the winning proposals. Remember, wherever in the world you compete, Michigan can give you the upper hand.



michigan.org

**MICHIGAN**  
ECONOMIC DEVELOPMENT CORPORATION

**THE UPPER HAND**





Photo by JOHN HEIDER/Northville Record

Ridge Wood student Mikey Shihadeh likes his fruit and vegetable selections at the school's cafeteria.

# Now serving: vegetarian lunchlines

## District goes to the 'dogs,' offers meatless entrees

By Victoria Mitchell  
RECORD STAFF WRITER

Mikey Shihadeh likes his dogs with chips.

And it was SunChips that motivated the fourth-grade student to try a veggie dog at Ridge Wood Elementary School.

Now Shihadeh may choose his favorite combo, or other vegetarian selections, as Northville Public Schools adds daily meatless options to its elementary school menu.

"We've always had some, we're just trying to do it more and more," said Robin Taksony, Northville Public Schools food service manager. "Every year the requests seem to increase."

Vegetarian burgers, dogs and cheese pizza were offered last year, but this is the first time the district is offering a different choice every day.

Menu choices include veggie chicken patties, veggie cheeseburgers, bean tacos and veggie chef salad.

Taksony said the decision factors in an increased dedication to student health and the district's growing multi-cultural community.

"I think it is great to have this opportunity for the students to select from many options," said Nancy Raynes, Ridge Wood Elementary School principal.

Raynes said during the first week of school less than 10 students selected vegetarian lunch options, but it is still early. Raynes said she will monitor students' vegetarian selections throughout the year.

Shihadeh said he recommends other students try the veggie hot dogs, despite his initial reaction.

"It felt like rubber," he said, conceding, the taste won him over.

Shihadeh said he also likes the school's cheese pizza and fresh fruit and vegetable selections - and of course, anything served with SunChips.

Taksony said the meatless versions of popular lunch items are made by Morningstar Farms, and are the same as those found in many grocery stores.

The new vegetarian menu is available at all Northville Public Schools elementary buildings.

Students may choose either a

**Elementary Veggie Options**

Veggie Chicken Patty	Bean Burrito
Veggie Cheeseburger	Taco with Beans
Veggie Dog	Cheese Nachos
Veggie Chef Salad	Meatless Sub Sandwich

SOURCE: Northville Public Schools

"Every year the requests seem to increase."

Robin Taksony

Food Service Manager, Northville Public Schools

meat or meatless entree and all lunches include choice of fruit, vegetable, bread and milk.

The district's elementary school hot lunch costs \$2.40 per day.

Victoria Mitchell can be reached at (248) 349-1700, ext 122 or [vmitchell@gannett.com](mailto:vmitchell@gannett.com)

The largest selection of Gems & Jewelry under one roof!

**The "Original" Classic INTERNATIONAL GEM & JEWELRY SHOWING.®**

**SEPT 29 - OCT 1**

**ROCK FINANCIAL SHOWPLACE**

46100 Grand River Avenue • Novi

<p><b>TOP QUALITY JEWELRY AT AFFORDABLE PRICES</b></p> <p><b>FREE PEARL NECKLACE with paid attendance*</b></p> <p><small>*One per person while supplies last</small></p> <p>DIAMONDS • SILVER WATCHES • GOLD OPALS • RUBIES RINGS • EARRINGS NECKLACES</p>	<p><b>ADMISSION</b></p> <p>16 &amp; Under FREE with an adult</p> <p>\$7-adults</p>	<p><b>3 DAYS ONLY!</b></p> <p>Friday 12p-6p</p> <p>Saturday 10a-6p</p> <p>Sunday 11a-5p</p>
--	--	---

NO STROLLERS OR PHOTOGRAPHY [www.InterGem.com](http://www.InterGem.com)

## A VERY BIG THANK YOU TO OUR CLIENTS.

**WHEN YOU'RE HAPPY, WE'RE HAPPY.**

**Chris J. Willerer, AAMS**  
Investment Representative

1039 Novi Road  
Northville, MI 48167  
Bus. 248.348.0423  
Toll free 866.348.0426  
[chris.willerer@edwardjones.com](mailto:chris.willerer@edwardjones.com)  
[www.edwardjones.com](http://www.edwardjones.com)

**Dan DeLano, AAMS**  
Investment Representative

128 N. Center Street  
Northville, MI 48167  
Bus. 248.348.9815  
Fax 866.462.5354  
[dandelano@edwardjones.com](mailto:dandelano@edwardjones.com)  
[www.edwardjones.com](http://www.edwardjones.com)

**David J. Boyd, AAMS**  
Investment Representative

117 East Dunlap  
Northville, MI 48167  
Bus. 248.348.4610  
Fax 888.348.4626  
[david.boyd@edwardjones.com](mailto:david.boyd@edwardjones.com)  
[www.edwardjones.com](http://www.edwardjones.com)

**Edward Jones**  
MAKING SENSE OF INVESTING

We're pleased to announce that Edward Jones has been ranked "Highest in Investor Satisfaction with Full Service Brokerage Firms, Two Years in a Row." We've always believed our way of doing business made sense for our clients. It's nice to know they agree.

To see how we can make sense of investing for you, contact one of our investment representatives today.

Edward Jones received the highest number of client satisfaction awards in a row among full service brokerage firms in the proprietary J.D. Power and Associates 2005-2006 Full Service Investor Satisfaction Study®. 2005 study based on 554 total responses measuring 20 brokerage firms and measures opinions of investors who used full service investment services. Proprietary study results are based on consumer experiences and perceptions of consumers surveyed from November 2005 to January 2006. Your experiences may vary. Visit [www.edwardjones.com](http://www.edwardjones.com)

# AUTUMN Sale!

Thursday, September 14th  
thru  
Sunday, September 24th

# 20% off

most everything in the store.\*

\*Some exclusions apply. Please ask a salesperson for details.

The Boys

Novi Town Center • 26020 Ingersol, Novi, MI 48375  
(248) 349-8090

Store Hours: Mon-Sat 10am-8pm, Sun noon-5pm

**Portaf Roble '04**  
This red Spanish blend is complete and flavorful.

**\$14.99** 750 ml.

Try This with Manchego Cheese

**Joe's Produce**

Michigan's Finest

**Kim Crawford '04**  
Marlborough Unoaked Chardonnay Full bodied and rich, stunning.

**\$18.99** 750 ml.

Try this with Pork Tenderloin

**Joe's Michigan Specials!**

<p>Michigan Locally Grown MacIntosh Apples</p> <p><b>99¢</b> lb.</p> <p><small>Perfect for Making Applesauce</small></p>	<p>Golden Ripe Pineapples</p> <p><b>\$2.99</b> ea.</p> <p><small>Whole, Cut or Cored</small></p>	<p>Michigan Gala Apples</p> <p><b>99¢</b> lb.</p> <p><small>Lunch Box Size Only!</small></p>
<p>Michigan Locally Grown Broccoli</p> <p><b>2/\$3.00</b></p> <p><small>Jumbo Heads</small></p>	<p>California Bartlett Pears</p> <p><b>99¢</b></p> <p><small>Hot Prices!</small></p>	<p>Michigan's Hard Squash</p> <p><b>49¢</b> lb.</p> <p><small>Assorted Buttercup Spaghetti &amp; Hubbard</small></p>
<p>Crow Canyon White Zinfandel</p> <p><b>\$4.99</b> 750 ml.</p> <p><small>Lightly Sweet and Pleasant</small></p>	<p>Lipari Mozzarella Cheese</p> <p><b>\$1.99</b> lb.</p> <p><small>Slice or Chunk. Whole loaf \$11.99 lb. Great for Pizzas &amp; Pasta.</small></p>	<p>Lakefront Brewery New Grist</p> <p><b>\$8.49</b> + Tax &amp; Deposit</p> <p><small>Wheat and Gluten Free Beer</small></p>
<p>Manchego Cheese Aged 6 Months</p> <p><b>\$10.79</b> lb.</p> <p><small>Special Hard Cheese. Great for Grating on Steaks &amp; Dishes.</small></p>	<p>Red Skin Potato Salad</p> <p><b>\$2.59</b> lb.</p> <p><small>Delicious!</small></p>	<p>Parmigiano Reggiano Cheese</p> <p><b>\$11.99</b> lb.</p> <p><small>Serve with Italian Dishes, great for grating on Pasta.</small></p>
<p>Mexicali Dip</p> <p><b>\$4.39</b> lb.</p> <p><small>Tasty with Joe's Tortilla Chips</small></p>	<p>Joe's White Corn Tortilla Chips</p> <p><b>2/\$4.00</b></p> <p><small>Great for Football Parties</small></p>	<p>Salsa Bean Dip</p> <p><b>\$2.99</b> lb.</p> <p><small>Another Great Party Favorite</small></p>

**Byrd's Choice Meats!**

**Back to School Specials!**

Our Own Oven Roasted Turkey Breast.....	\$5.89 lb.
Kowalski Polish Ham.....	\$3.89 lb.
Eckrich Regular Bologna.....	\$1.98 lb.
Yellow or White American Cheese.....	\$2.89 lb.

All Sliced to Your Liking!  
33066 W. Seven Mile • Livonia 248-478-8680

Shop at Joe's for all your Back to School shopping needs! Please Be Patient with all the construction & renovating going on here. Joe's appreciates all his loyal customers for shopping with us. We will be open our normal Business Hours during the Renovation. Stop by and visit us.

Hours: Mon-Sat. 9am to 7pm and Sundays 9am to 5pm  
Prices Good Through September 17, 2006

**Joe's Produce**  
33152 W. Seven Mile • Livonia, MI 48152 [www.joesproduce.com](http://www.joesproduce.com) (248) 477-4333

# The power of four

Adding four minutes to school day is hitting some students where it hurts — the pillow

By Victoria Mitchell  
RECORD STAFF WRITER

For Kirby Brackel, minutes feel more like hours when added to her school day.

"It seems like class goes by slower," she said.

The Northville High School junior is one of thousands of students who feel the impact of an extra four minutes added to the school day.

The time was added to meet district academic standards.

High school students now attend classes from 7:21 a.m.-2:16 p.m., a change from last year's 7:25 a.m. start time.

"I now have to leave my house at 7 a.m.," said sophomore Whitney Smith. "It takes like 10 minutes to get here, and I live right there."

Brackel agrees. She said the four minutes translates into about 10 minutes of commute time.

Both students said they face more morning traffic during their

commute.

The decision to add four minutes to the beginning of the public school day was included in the district's tentative 2006-07 calendar.

School officials said adding minutes, along with shortening February break, allows students to continue attending class 180 days each year.

According to data collected by the Northville Education Association, Northville is at the high end when it comes to the number of days students attend school.

Walled Lake Consolidated School districts, the envy of many Northville students, holds class 169 days per school year.

Bloomfield Public Schools holds classes 180 days followed by Troy Public Schools offering instruction 179 days.

"Although a minimum still holds and makes sense," said Leonard Rezmierski, Northville Public Schools Superintendent.

"I still subscribe we should be with children more than 180 days."

Rezmierski said hitting the 180-day mark is more in line with the global market, where in many cases students attend class 200-240 days a year.

According to state law, public school districts must provide 1,098 hours of instructional service, but the number of days it takes to achieve that goal is not mandated.

Northville High School sophomore Rachel Thompson said she is all for adding time to her day.

"I like it," she said. "It means we will get out earlier."

Thompson said she would rather add a couple of minutes to each day to complete the district's 180-day requirement, rather than adding on to summer vacation.

Victoria Mitchell can be reached at (248) 349-1700, ext. 122 or vmitchell@gannett.com.

## School Calendar Comparison

DISTRICT	STUDENT DAYS	TEACHER DAYS
BIRMINGHAM	176	179
W. BLOOMFIELD	177	181
WALLED LAKE	169	179
TROY	179	185
LIVONIA	175	182
NOVI	176	188
BLOOMFIELD	180	188
S. LYON	175	182
NORTHVILLE	180	187

SOURCE: Northville Education Association

## NORTHVILLE NEIGHBORS

### Aram Sarkisian

Aram Sarkisian was ordained a sub-deacon at St. John Armenian Church of Greater Detroit in Southfield, Sunday, Sept. 10 during a pontifical Divine Liturgy. Aram is a 2004 honors graduate of Northville High School, a Boy Scout Troop 755 Eagle Scout and a junior at the University of Michigan where he is a member of two honor societies: the Golden Key and Delta Epsilon Iota. In addition to his service to the Armenian Apostolic Orthodox Church, Aram recently returned from a building project with Habitat for Humanity in Armenia, is a member of the Michigan Marching Band and Michigan athletic pep bands, and an officer of Nu Chapter of Kappa Kappa Psi national honorary band fraternity. He is the son of Dr. Edward and Anna Sarkisian of Northville.

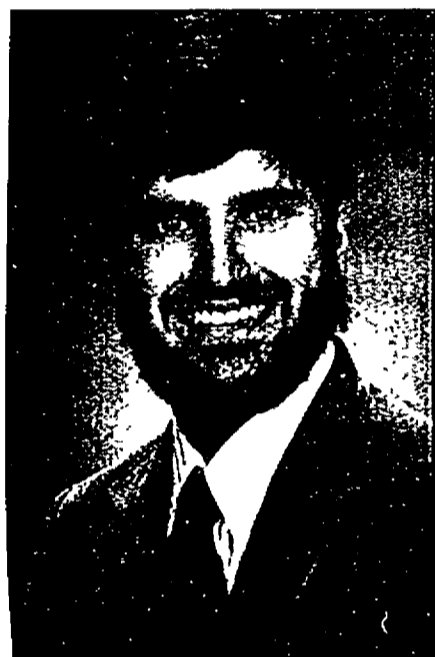

## TWO GREAT SALES - ONE GREAT DAY

SIDEWALK CLEARANCE & ORIGINAL FRAMED ART SALE

SATURDAY, SEPTEMBER 16  
10:00 AM - 5:00 PM

Bailey & Shamoun INTERIORS

INSPIRATION BEGINS HERE

767 Doheny Drive • Northville, MI 48167 • 248.380.7808

Just outside downtown Northville, 1/2 block east of the Chamber of Commerce Office

## Expecting Someone?



### THE MERLE AND SHIRLEY HARRIS BIRTHING CENTER AT HURON VALLEY-SINAI HOSPITAL

- Beautiful, all private birthing suites, for labor, delivery, recovery and postpartum (LDRP) care
- Anesthesiologists available 24 hours a day
- Complete-care nursery including full-time neonatology service for infants with special needs
- High-risk pregnancy, infertility and genetics services\*

\*All in conjunction with Hutzel Women's Hospital and Wayne State University.



### Expect the Best.

To schedule a tour of the Merle and Shirley Harris Birthing Center at Huron Valley-Sinai Hospital, call (248) 937-5120. To schedule an appointment with one of our physicians, call (888) DMC-2500.

**DMC**  
Huron Valley-Sinai Hospital  
DETROIT MEDICAL CENTER/WAYNE STATE UNIVERSITY

1 William Carls Drive • Commerce, Michigan • 248-937-3300 • www.hvsh.org

At Commerce & Commerce in Commerce.



## Come See What's Cookin' at Seattle Sutton's Healthy Eating

- 3 meals/day • 7 days/week
- No shopping • No cooking
- Over 100 different meals
- Meals are **FRESH**, not frozen
- Includes fresh fruit, salads and delicious bakery items
- Low calorie • Low fat • Great taste!
- No contracts • No meetings
- All for only about \$17 a day



Lose Weight • Save Money  
**SAVE \$25.00**  
Off our 5-Week Plan

Expires 12/31/06. Not combinable with any other offer. Not redeemable for cash. Call for Details.

1-888-MEALS-21  
www.meals21.com

## CLASS NOTES

### Book Collection

Moraine Elementary School is collecting donations of new or gently used books for students at Roberto Clemente School in Detroit. Moraine families are invited to make a donation through Wednesday, Sept. 20. A drop box is available in the main hallway for book drop off.

### Moraine Principal

Lynn Babcock, Ed.D., joins Moraine Elementary School as interim principal for the 2006-07 school year. She replaces former principal Mary Kay Gallagher, who was appointed assistant superintendent for curriculum and instruction for the district. Babcock comes to Moraine with 24 years of experience as an elementary school principal, including 13 years at Grant Elementary School in Livonia. School officials said the search for a permanent Moraine principal will begin spring 2007 when the candidate pool is the strongest. There will be an opportunity for staff and parents to be involved in the selection process, they said.

### Bug Hunt

The Friends of the Rouge annual Fall Bug Hunt is 9 a.m.-3 p.m. Saturday, Oct. 14 meeting at Schoolcraft College's VisTaTech Center. Kids are welcome when accompanied by one adult per child, and groups are limited to six individuals. Sites are located throughout the metropolitan area on small Rouge streams. Registration is required by Oct. 6. For more information, call (313) 792-9621 or e-mail [picoordinator@therouge.org](mailto:picoordinator@therouge.org).

### Football fans

The Northville Football Parents Association will be selling Northville Mustangs front license plates today and Friday. The plates are \$5 and will be sold during lunchtime. The association will also be taking orders for "Beat Novi" T-shirts (\$15) and hoodies (\$35).

### Athletic passes

Family passes for 2006-07 Northville High School athletic events are available. The cost is \$60 for a regular pass and \$75 for a Super Pass, which includes hockey. Each immediate family

member (up to six people) receives a non-transferable pass, allowing admittance to all home athletic contests Sept. 2006-June 2007, not including districts and conference competitions. Money generated from selling the pass goes directly to Northville High School sports. For more information, call (248) 348-4277.

### Get your ticket

Music booster \$100 raffle tickets are now on sale benefiting the Northville High School choir and band programs. More than \$40,000 will be awarded to 25 winners, with a top prize of \$15,000. Only 1,000 tickets will be sold. Tickets are available at the high school open house, all NHS home football games and during the Victorian Festival. For more information, call Mary Jo Ring at (248) 465-9987 or e-mail [mjrandhjr@comcast.net](mailto:mjrandhjr@comcast.net).

### Board Meeting

The next Northville Board of Education regular meeting is 7:30 p.m. Tuesday, Sept. 26 at Northville High School, 45700 Six Mile Road.

### St. Paul's Kindergarten

Children who will be 5 by Dec. 1 may register now for full- or half-day kindergarten at St. Paul's Lutheran School, 201 Elm St. For more information, call the office, (248) 349-3146 or stop by the school from 8:30 a.m.-4:30 p.m. Monday-Friday.

### Early Education Openings

Northville Public Schools Early Childhood Center is enrolling for the 2006-07 school year. Openings are still available in the Child Care Classes at Thornton Creek and Main Street, 3-year-old Kids' Creative Corner preschool classes and the Parent/Child Classes for 1- and 2-year-old children. For more information, call the Early Childhood Center Office at (248) 344-8465.

### Co-op Preschool

Novi Co-op Preschool is hosting an open house 6-8 p.m. Wednesday, September 20 at the school. Teachers will be available to answer questions, and parents and preschoolers are invited to visit. Enrollment is still available for the 2006-07 school year. For more information, call the Novi

Co-op Preschool at (248) 349-3223, or visit [www.novipreschool.com](http://www.novipreschool.com).

### Old Village/Cooke Golf Outing

The Old Village and Cooke schools golf outing is Saturday, Sept. 30 at St. John's Golf and Conference Center. Event organizers are looking for hole and contest prize sponsors, raffle prizes and golfers. Proceeds from the fund-raiser will be distributed between both schools to support music therapy, leisure recreation and student equipment needs. For more information, contact Old Village School, (248) 344-8460 or Cooke School, (248) 344-8489.

### Reflections Contest

The theme for the 2006-07 Reflections contest is "My favorite place..." Entries are due immediately after Thanksgiving break. Submissions in the categories of literature, music composition, photography and art will be accepted. The PTA national competition honors student creativity in the field of arts.

## ON CAMPUS

### Grand Valley State University

Northville Resident Scott David Paterson graduated with a Bachelor of Arts in Film and Video degree, April 29, 2006.

### AT&T Announces Scholarships

Northville resident, Nicole Brants, has been awarded the AT&T Foundation Scholarship for the 2006-2007 school year. Brants is a Ladywood High School graduate and attends Loyola University, majoring in English and secondary education. She is a Chicago Public Schools Academic Coach, High School Tutor, Circle K International member, and on the dean's list.

**WHAT A CHILD LEARNS ABOUT VIOLENCE A CHILD LEARNS FOR LIFE.**

Teach carefully. We can show you how. Call 877-ACT-WISE for a free brochure or visit [www.act.org/nvviolence.org](http://www.act.org/nvviolence.org)

## OFFICE HOURS

### Office Hours

State Sen. Bruce Patterson's (R-Canton) district representative, Sue Trussell, will hold 11 a.m.-1 p.m. office hours for all constituents of the 7th Senate District Tuesday, Sept. 12. This session will be held at the Plymouth Library, 223 S. Main St., in Plymouth. For more information, contact the Plymouth Library at (734) 453-0750, or by calling Sen. Patterson's office at (866) 262-7303 or (517) 373-7350.

watch your

# Money Grow

with us

**4.75%**  
\*APY  
Money Market  
\$10,000+

**5.40%**  
\*APY  
6 Month  
Certificate of Deposit

**5.40%**  
\*APY  
12 Month  
Certificate of Deposit

**IRAs**  
\$250,000\*  
FDIC Insured

Questions? Comments? Call us, and we'll respond personally within the same business day. That's our guarantee.

## TWO TERRIFIC WAYS TO GET THE NATION'S BEST, MOST RELIABLE WIRELESS NETWORK



**Music**

V CAST Music, Bluetooth® Headset and VZ Navigator™ Capable

**GET ONE FREE**  
WHEN YOU BUY ONE

**\$49.99**

After Mail-in Rebate: 1st phone \$99.99 2 year price - \$50.00 Mail-in Rebate

Samsung a930

**OR**

**Navigation**

Camera Phone, Bluetooth® Headset and VZ Navigator™ Capable

**GET ONE FREE**  
WHEN YOU BUY ONE

**\$29.99**

After Mail-in Rebate: 1st phone \$79.99 2 year price - \$50.00 Mail-in Rebate

Samsung a870

With new 2 year activation per phone.

**ADD LINES ONLY**

**\$9.99** Monthly Access  
Per Additional Line

AND GET **Unlimited Calling**

TALK TO ANY VERIZON WIRELESS CUSTOMER WITHOUT USING YOUR PLAN MINUTES.

When you activate 2 lines on a Family SharePlan® \$69.99 or higher. When calling from within the America's Choice® Coverage Area. With new 2 year Agreement per line. (Activation fees, taxes & other charges apply)\*



### IT'S THE NETWORK<sup>SM</sup>

DOES YOUR JOB QUALIFY YOU FOR SPECIAL DISCOUNTS? Go to [verizonwireless.com/value](http://verizonwireless.com/value) for details.

CALL **1.877.2BUY.VZW** PARA ESPAÑOL **CLICK** [verizonwireless.com](http://verizonwireless.com)



**MICHIGAN HERITAGE Bank**

[www.miheritage.com](http://www.miheritage.com)

**Farmington Hills**  
28300 Orchard Lake Rd.

**Troy**  
1917 E. Big Beaver

**Livonia**  
18770 Farmington Rd.

**Novi**  
21211 Haggerty Rd.

**Wixom**  
28345 Beck Rd., Suite 102

\*APY is Annual Percentage Yield. Must open a Classic Checking Account with a deposit of at least \$1,000 to receive advertised rates on the Certificates of Deposit or Money Market. Lower interest rates for balances less than \$10,000 in the money market. Rates subject to change. Rates effective as of August 3, 2006. Substantial penalty for early withdrawal on the Certificates of Deposit. \$7.50 service fee if the Money Market balance falls below \$2,500. Any fees may lower the rate of return on the account. Certificates of Deposits require a minimum of \$500 to open. Money Market rate is available on new money only.

Member FDIC Equal Housing Lender

Member FDIC Equal Housing Lender

Meet Craig Monroe from the Detroit Tigers on Saturday, September 16, from 12:30 - 1:30pm at our Troy Sports Center Store.

VERIZON WIRELESS COMMUNICATIONS STORES

<p><b>ANN ARBOR</b> 2570 Jackson Ave. (next to Blockbuster) 734-769-1722</p> <p><b>COMING SOON!</b> 3365 Washtenaw Ave., Suite E 734-973-8336</p> <p><b>Branwood Mall</b> (in Sears Wing, near Center Ct.)</p> <p><b>ARBOR HILLS</b> Great Lakes Crossing Mall 248-253-1799</p> <p><b>Courtyard Center Mall</b> (near JC Penney)</p>	<p><b>BRIGHTON</b> 8159 Chellis, Suite C (off Grand River, in front of Target) 810-225-4783</p> <p><b>BURTON</b> 1295 S. Center Rd. (at corner of Lapeer Rd.) 810-743-4846</p> <p><b>Courtyard Center Mall</b></p> <p><b>CANTON</b> 42447 Ford Rd. (corner of Ford &amp; Lilley Rds., Canton Corners) 734-844-0481</p> <p><b>DEARBORN</b> 24417 Ford Rd. (just West of Telegraph) 313-278-4491</p> <p><b>Farlane Mall</b> (3rd floor next to Sears) 313-441-0168</p> <p><b>DETROIT</b> 14126 Woodward (Model T Plaza) 313-869-7392</p>	<p><b>FARMINGTON HILLS</b> 31011 Orchard Lake Rd. (SW Corner of Orchard Lake Rd. &amp; 14 Mile Rd.) 248-538-9900</p> <p><b>FENTON</b> 17245 Silver Pkwy (in the Sears Plaza) 810-629-2733</p> <p><b>FT. GRATWIT</b> 4129 24th Ave. 810-385-1231</p> <p><b>LAKE ORION</b> 2531 S. Lapeer Rd. (Orion Mall 2 miles N. of the Palace) 248-393-6800</p> <p><b>NORTHVILLE</b> Three Generations Plaza 20580 Haggerty Rd. 734-779-0148</p> <p><b>NOVI</b> 43025 12 Mile Rd. (Twelve Oaks Service Dr., North of Sears) 248-305-6600</p>	<p><b>Twelve Oaks Mall</b> (lower level play area)</p> <p><b>PONTIAC/WATERFORD</b> 454 Telegraph Rd. (across from Summit Place Mall) 248-335-9900</p> <p><b>ROCHESTER HILLS</b> 3035 S. Rochester Rd. (at Auburn Rd.) 248-853-0550</p> <p><b>ROYAL OAK</b> 31921 Woodward Ave. (at Normandy) 248-549-4177</p> <p><b>ST. CLAIR SHORES</b> 26401 Harper Ave. (at 10 1/2 Mile) 586-777-4010</p>	<p><b>SOUTHFIELD</b> 28117 Telegraph Rd. (South of 12 Mile Rd.) 248-358-3700</p> <p><b>STERLING HEIGHTS</b> 45111 Park Ave. (M-59 &amp; M-53, Uca Park Plaza) 586-997-6500</p> <p><b>Lakeside Mall</b> (Lower Ct. play area)</p> <p><b>TAYLOR</b> 23495 Eureka Rd. (across from Southland Mall) 734-287-1770</p> <p><b>Southland Mall</b> 23000 Eureka Rd. (in the JC Penney wing)</p>	<p><b>TROY</b> 1913 E. Big Beaver Rd. (Troy Sports Center) 248-526-0040</p> <p><b>Oakland Mall</b> (inside Main Entrance, next to Food Court)</p> <p><b>WESTLAND</b> 35105 Warren Rd. (S.W. Corner of Warren &amp; Wayne Rds.) 734-722-7330</p>	<p>OR VISIT THE VERIZON WIRELESS STORE AT CIRCUIT CITY</p> <p><b>ANN ARBOR</b></p> <p><b>ARBOR HILLS</b></p> <p><b>DEARBORN</b></p> <p><b>HASPER WOODS</b></p> <p><b>NOVI</b></p> <p><b>ROSELLE</b></p> <p><b>TAYLOR</b></p> <p><b>TROY</b></p> <p><b>WESTLAND</b></p> <p style="font-size: small; margin-top: 10px;">See store for Return/Exchange Policy.</p>
--	--	---	--	--	---	---



Teamed with



Free Handset Software Upgrade!



Proud sponsor of the Detroit Tigers



Drive responsibly. Call with care.

\*Our Surcharges (incl. 2.37% Federal Universal Service charges quarterly), \$4 Regulatory & 4-0% Administrative fee/line, & others by area are not taxes (details: 1-800-684-1888), gov't taxes and our surcharges could add 4% to your bill. Activation fee/line: \$35. IMPORTANT CONSUMER INFORMATION: Subject to Customer Agreement, Calling Plan, Rebate Form & credit approval. \$175 early termination fee/line, up to 45¢/min. after allowance. Usage rounded to next full minute. Rebate takes 8-10 weeks. While supplies last. Limited time offer. Network details & coverage maps at [verizonwireless.com](http://verizonwireless.com). Offers, coverage & service not available everywhere. Max 5 lines, all on same account. V CAST Music: Charges & conditions may apply. VZ Navigator Download, subscription and airtime required for use; only in National Enhanced Services Coverage Area. ©2006 Verizon Wireless

# Get moving, Northville

## Recreation sessions offers aquatics to yoga

By Maureen Johnston  
RECORD STAFF WRITER

The kid's face in the leaves has been sitting on your kitchen counter for two weeks now.

If you're going to make fall registration deadlines, classes are starting. It's time to pick up the Northville Parks and Recreation Department brochure.

"People are really busy," said recreation director Traci Sincock. "They do wait until the last minute. They pick up something and say, 'I want to do that,' then there's not time in the day to do something."

"It's always hard to find that balance." Now that the kids are off to school, temperatures are cooling and a fall routine is kicking in, the time has come to select an overlooked area of interest. The department mailed 48 pages of special event, course and activity options to 22,000 Northville community residents in mid-August.

Take Pilates Mat Work, for example. The brochure offers "body sculpting" opportunities Monday and Thursday, starting next week at the Northville Senior Community Center. The 10-week hour-long class costs \$99.

Sincock said there still are openings in beginning pilates and other fitness classes, offered on a drop-in basis for the first time. Recreation staff members try to wait as long as possible before canceling classes due to lack of enrollment, she said.

"We hope we have something to appeal to all ages and interest levels," she said. "Not everyone is into sports, not everyone is into cultural activities or group activities."

"Our goal is to try to create some interest for every resident."

Translation: There's no reason to be a slug in Northville.

Sincock pointed out highlights in the brochure:

### Group fitness

Group classes formerly provided by the Water Wheel Health Center — BodyPump, BodyCombat, BodyStep, Fit-Yoga, Yoga, Pilates, Aerobics 101, Group Cycle and Burn — are among several new recreation department

course offerings. Participants can purchase a monthly pass for \$45, allowing participants to attend as many classes as they want during the month. Or, there is a \$5 per class option to sample courses.

### Santa sighting

On Nov. 18, the recreation department will host Santa at the Northville Senior Community Center for \$10 timed visits with local children. The event, geared toward preschool through third graders, will coincide with the 25th annual hometown holidays annual Christmas walk hosted by the Northville Chamber of Commerce and replace Bandshell Park visits.

"We're excited about that and tying it into all the rest of what's going on in the community," Sincock said. "Mom and Dad can buy their greens and hear carolers and the kids can go see Santa and not stand in line at the mall."

### Dog park training

Requirements for use of the Cady Street or Northville Community Park dog parks include dog owner attendance at an educational session provided by the recreation department.

### Introducing the symphony

The Plymouth Symphony Orchestra, set to appear in the Northville High School auditorium, Nov. 18 and Feb. 10, will gain a little advance exposure through recreation department course offerings. On Nov. 2, the symphony's music director Nan Washburn will host a \$4, 90-minute "audience-participation" class about the art of conducting an orchestra at the Northville Senior Community Center.

### By fax, walk-in or mail

Check the class start date to determine whether time allows for mailed registration, including a check or credit card information.

## Ready for recreation?

- ✓ Check Your Area of Interest
- 📅 Note Days and Times Offered
- 💰 Determine Fee
- ✉ Register By: MAIL 700 W. Baseline Road
- DROP-IN 7a.m. - 4:30p.m.
- Monday - Friday
- FAX 248-380-8611

SOURCE: Northville Parks and Recreation

Drop in to the Hillside Recreation Center office, 700 W. Baseline Road, from 7 a.m.-4:30 p.m. Monday-Friday. Or, fax the registration form along with a credit card number and expiration date to the recreation office at (248) 380-8611.

### Check the schedule

To view the fall 2006 parks and recreation brochure, visit the department's Web site [www.northvilleparksandrec.org](http://www.northvilleparksandrec.org). Or pick up a brochure at the main office, located behind Hillside Middle School.

### Not yet online ...

Sincock said the department is investigating jointly purchasing registration software with the City of Plymouth. "It's in the works for the Internet," Sincock said. "We still feel there's enough of a cost value."

Registration for the recreation department's winter session is the soonest on-line capability could be in place, she said. Meanwhile, faxed class sign-up sheets began in earnest Sept. 7.

**"Not everyone is into sports, not everyone is into cultural activities or group activities. Our goal is to try to create some interest for every resident."**

Traci Sincock

Director, Northville Parks and Recreation Department

Sincock said. "What that demonstrates to me is people want the convenience of not coming in to register," she said.

Maureen Johnston can be reached at (248) 349-1700, ext. 103, or via e-mail at [mjohnston@gannett.com](mailto:mjohnston@gannett.com).

## Disc Herniation?

New FDA Approved Technology Treats Herniated Discs Without Drugs or Surgery

Suburban Detroit - A new free report has recently been released that reveals an amazing new medical breakthrough that has proven 86% successful treating debilitating back pain. Even with multiple herniated discs. Find out how space travel solved astronauts back pain and how this accidental discovery has let to the most promising back pain treatment today. For your free report entitled, "How Space Age Technology Is Solving Back Pain Without Drugs Or Surgery?" call 1-800-469-3618 and listen to the toll-free 24 hr. recorded message for all the details. If phone lines are busy, visit: [www.midischerniation.com](http://www.midischerniation.com)

060469877



So, you want to go back because Franklin Bank opened a branch in your neighborhood?!

Limited Time Grand Opening Offers!

5.55% APY  
7 Month CD\*

5.40% APY  
Ultimate Savings Account\*

Are you ready for a little slice of heaven right here on earth? Drop into Franklin Bank — with two new locations now open in Livonia and coming soon to Shelby Township. Featuring an out-of-this-world array of personal and business banking products like low-cost checking, high-paying money markets and CDs, next day funds availability and that famous Franklin personal service that will have you floating on cloud nine

**FRANKLIN BANK**

[www.franklinbank.com](http://www.franklinbank.com) • Member FDIC

Livonia  
47900 Haggerty Rd.  
800-527-4447

Shelby Township  
50787 Corporate Dr.  
800-527-4447

## MUM'S THE WORD

BIG...BUSHY...  
BEAUTIFUL...  
MUMS!

Compare our LARGE home grown mums. Starting at \$4.99

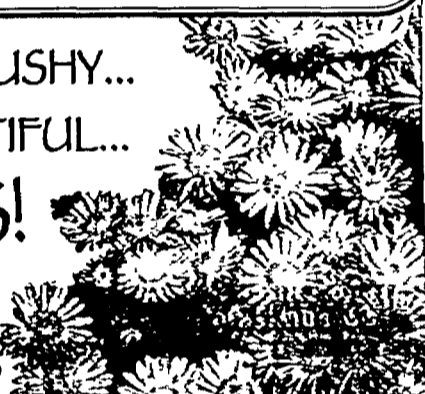

NOW is the time to apply STEP 4

- stronger roots
- vigorous, thicker lawn
- green up quicker next spring

\$34.99

SPRING BULBS  
EARLY BIRD GETS THE BEST SELECTION!  
15 Bulb packages reg. \$7.99 \$5.99

**PLYMOUTH NURSERY and GARDEN CENTER**

734-453-5500

[www.plymouthnursery.net](http://www.plymouthnursery.net)

SUMMER HOURS: Mon-Sat 8:30-6  
Fri 8:30-7 • Sun 10-4  
Offers Expire 9/20/06

9900 Ann Arbor Rd./Plymouth Rd.  
7 Miles West of I-275  
1 1/2 Miles South of M-14  
Corner of Gottfredson Rd.

## Passageways TRAVEL

Exclusive FASTBREAKS™ 2007  
Vacation Values Booklet Now Available!

- featuring
- APPLE VACATIONS.com  
America's Favorite Vacation Company
  - BOOK BY SEPTEMBER \$50 OFF Charter departures from Detroit
  - BOOK BY OCTOBER \$50 OFF RIU Hotels package bookings\*
  - BOOK BY SEPTEMBER \$50 OFF All packages to Los Cabos!

## Free Travel Show!

September 27 • 4 PM - 8:30 PM

Burton Manor  
27777 Schoolcraft, Livonia, MI

- Dozens of cruise lines, tour companies & hoteliers
- Seminars on popular destinations & special offers
- Passageways exclusive FASTBREAKS vacation values
- Live booking for winter vacations
- Win a vacation, free airline tickets and more!

Novi  
248 449.7300  
800 293.7310

Visit us online at  
**Passageways**  
TRAVEL.COM

Rochester  
248 652.1990  
800 962 4189

## Lose Weight for Life!

St. Mary Mercy Bariatric Center... a Minimal Surgical Approach to Treating Obesity



- Tallal Zeni, MD, Bariatric Center Director  
Minimally Invasive and Bariatric Surgery
- Fellowship, Evanston Northwestern Healthcare, Chicago, IL
  - Experienced in advanced laparoscopic gastric bypass surgical techniques
- Paula Magid, Bariatric Program Director
- Program Manager of the Year Award - 2004
  - A post-op patient happy to share her experience

St. Mary Mercy Bariatric Center • Marian Professional Bldg., Suite 311 • 14555 Levan Road • Livonia, MI

Read our patient reviews on [obesityhelp.com](http://obesityhelp.com)

Call 734.655.2692 (toll free 877-WHY-WEIGHT) • [www.stmarymercy.org](http://www.stmarymercy.org)

**ST. MARY MERCY HOSPITAL**

Great doctors and nurses. In your own backyard.

## Are you an organ & tissue donor?

Ask your family today, and let them know your decision, too. That way you'll know, they'll know, and there will be no question later.

For a free brochure, call 1-800-355-SHARE.

Share your life. share your decision.™ Michigan Coalition on donation

Ad Council

Organ & Tissue  
COALITION ON DONATION  
Share your life. Share your decision.™

# ALLEN, STUBENVOLL: Northville mourns loss, bygone era

continued from 1A

## Mayor 'Mike' Allen

Allen, known for his dedication to community service, was immortalized in 1978 with the construction of city-owned apartment complex, Allen Terrace.

"It just seemed natural," said current Mayor Christopher Johnson. "He was retiring at the time they were opening it."

Jim Allen, Mike Allen's son and the city's fire chief, recalled when that honor was bestowed on his father.

"That wasn't his intent," he said. "He took a lot of pride and had a lot of concern from the time he got involved in politics."

"He was a clear thinker and had a vision of what he wanted to see in the community."

The younger Allen also remembered his father's commitment to maintaining Rural Hill Cemetery for the city, duty the former monument company owner performed gratis for 40 years.

"It was just a dedication," he said.

Named Northville Chamber of Commerce Citizen of the Year in 1977, Allen belonged to many community organizations, including the Northville Masonic Lodge 186, Rotary Club and First Presbyterian Church.

"He was a true icon of Northville," said former chamber president Laurie Marrs. "He was a wealth of knowledge. He truly had the city of Northville in his heart from the get-go."

Behind his dedication to the city, Allen's widow,

Betty, said her husband of 30 years was devoted to his family.

"He was a true gentleman, such a kind thoughtful man, always trying to think of someone else first," she said. "Northville meant everything to him."

"We went up and down the streets — he knew where every manhole, where every thing was supposed to be."

"He lived and died Northville, he sure did."

## John Stubenvoll

Back in 1954, Stubenvoll presented to the community the financial advantages of city incorporation, including street pavement, water system improvements and extended street lighting. His vote was one of the original council's five that changed Northville's organizational structure from village to city.

In 1957, Stubenvoll retired from the city council after one term. But not without making his mark, Sliger said.

"He was a strong advocate of the city manager form of government," Sliger said. "With Stubenvoll and Allen on it, it's turned out to be a long-term and proper form of government in a community our size."

"Those two fellas were a part of it." Stubenvoll, a 1936 Northville High School graduate, began as a bank teller for the Depositors State Bank of Northville, which later merged with Manufacturers Bank, now Comerica. He retired in 1976 as a bank vice president.

Memorials in his name can be made to the American Cancer Society, 18505 W. 12 Mile Road, Southfield, MI 48076 or to Angela Hospice, 14100



Photo Courtesy of the NORTHVILLE HISTORICAL SOCIETY

City officials gather prior to the City of Northville's first council meeting. SEATED, LEFT TO RIGHT: Councilmember Earl Reed, Clerk Mary Alexander, councilmembers John Stubenvoll, Malcolm "Mike" Allen and John Canterbury and Mayor Claude Ely. STANDING, LEFT TO RIGHT: Treasurer A. Russell Clarke and city attorney Phillip Ogilvie.

Newburgh Road, Livonia, MI 48154-5010.

Memorials in Allen's name can be made to the Northville Historical Society, Allen Terrace or the First Presbyterian Church.

Maureen Johnston can be reached at (248) 349-1700, ext. 103, or via e-mail at mjohnston@gannett.com.

## Public safety staff may increase

By Renee Saunders  
RECORD STAFF WRITER

Staffing is a major issue as Northville Township officials prepare the budget for next year.

But officials aren't looking to cut jobs — they're adding them.

The Board of Trustees is set to approve the preliminary budget during a 7:30 p.m. Thursday, Sept. 21 meeting. The final budget will be approved in October.

Township Manager Chip Snider said increased public safety staffing is possible because of an Aug. 8 millage approved by township voters and years of thrifty spending.

"The levels of service for the township are determined by the elected officials," Snider said. "When they approve this budget, they will be approving service levels to the community. Our job as staff is to ensure service quality."

Snider said the staffing level at the fire department has been steadily expanding during the last five years and may continue to grow this year.

"We wanted to increase staff to an acceptable level," Snider said. "We had to mitigate lack of staffing in the past with over-time and shift replacement."

Snider said there are 20 full-time firefighters working for the township now and he expects four to

five new hires within the next two years.

"We're looking at an inspector position this year," Snider said. "With an aging community, we want to ramp up inspections to ensure safety to the public."

Snider said the fire department currently does inspections on a shift-by-shift basis.

He said the township also plans to add officers to the police department.

"We're trying to make a determination this year for a total number of officers," Snider said. "We have 32 police right now, but we expect 34 to 35 to be at top gun."

The police department hired a new officer last month.

Paul Harris III was sworn in Monday, Aug. 21 by clerk Sue Hillebrand.

Though one position was filled, Township Police Chief John Werth said he currently has two empty positions that were budgeted for this year. He said he plans to add one additional position to his staff in his budget.

"We're in the process of recruiting and getting good applicants," Werth said. "With the one additional position, we'll be at full strength."

Renee Saunders can be reached at (248) 349-1700 ext. 110, or via e-mail at rsauanders@gannett.com.

## SOUTH LYON THEATER

Newly Renovated Theater

STARTS Fri, Sept. 15<sup>th</sup>

## INVINCIBLE

Mark Wahlberg • Greg Kinnear

Rated PG 104 Min

7pm Everynight

No Matinees

Evenings

Adults \$4.50 Kids \$4.00

Tuesdays \$3.00

Wednesday

FREE sm. Popcorn with paid admission

Thursday

FREE Ice Cream with paid admission

Monday is

Senior Citizen Night

\$3 admission

126 E. Lake St.

437-4545

## The 2006 South Lyon Area Pumpkinfest

Presented by your community grocer - Larry's Foodland

**Saturday, October 7<sup>th</sup>**  
**Sunday, October 8<sup>th</sup>**

Enjoy:

A fun family activity venue with rides, games and activities brought to you by Telcom Credit Union

The Fabulous Arts & Crafts Show

The Parade through South Lyon

The Dog Show, Pie Eating Contests, the Great Pumpkin contest and so much more.

**NEW FOR 2006!**

Come ride the trolley and enjoy visiting the South Lyon Area including the Family Activity Area, craft show, Downtown South Lyon and other area hot spots.

Be at the Family Activity Area **Sunday, Oct. 8<sup>th</sup>, 1 - 3pm** to visit Radio Disney. Chances to win prizes and so much more!

**The South Lyon Area Pumpkinfest**  
Great family fun while supporting your Community



**Whatever it takes. bryant**  
Heating & Cooling Systems

**REWARD YOURSELF WITH LOWER UTILITY BILLS PLUS \$1,100 REBATE**

In our eyes, nothing is more valuable than feeling comfortable. Especially when it comes to making a Bryant purchase. So when you choose a Bryant high-efficiency heating and cooling system, we'll give you a rebate up to \$1,100.00 on qualifying units and systems. Its just another one of our ways of making sure your comfort always comes first. **Whatever it takes.**

**Day & Night Heating & Cooling Co.**  
Service and Installation of Furnaces, A.C. units, Boilers, Air Cleaners, Humidifiers

FREE ESTIMATES **248-474-2226**  
SERVING THE COMMUNITY SINCE 1973

MEMBER OF SOUTHEAST MICHIGAN HEATING & COOLING DEALERS ASSOCIATION

**Flexsteel.**

custom order SALE

**40% Off\***

Exclusive to Flexsteel Galleries only!

**All custom ordered Flexsteel furniture Including Sofas, Chairs And Tables**

**Sales Event**  
**September 21 - October 10, 2006**

**UP TO 60% OFF\* Floor Samples**

**Your Nesting Place**  
HOME FURNISHINGS  
new furniture and accessories

12 Month  
• NO INTEREST  
• NO PAYMENTS  
FINANCING AVAILABLE

332 N. Main St. Downtown Milford, MI 48381

**248-685-7314**  
HOURS: MONDAY 10 TO 5, TUES., WED., 10 TO 6, THURS. & FRI 10 TO 7, SAT 10 TO 6

## Northville Record

Rich Ramhoff  
PRESIDENT & PUBLISHER  
Grace Perez Perry  
GENERAL MANAGER  
David Aguilar  
EDITOR  
Richard Perlberg  
EXECUTIVE EDITOR

Our fundamental purposes are to enhance the lives of our readers, nurture the home towns we serve and contribute to the business success of our customers.

## Try Northville this weekend

What's the hook of the Victorian Festival?

We're all busy with fall festivities and work spilling over into the weekend.

What Victorian carrot is going to make you visit your crowded downtown this weekend?

People make up the crowd. The daughter taking pies in the face in the high school choir's booth to raise money for their spring trip, the mom who found the perfect crinoline at the clothing sale last weekend and the grandpa who will spring for the ducks to enter Sunday's race.

Even event organizers acknowledge suspenders and hoop skirts aren't for everyone, but they've tried to arrange attractions that pull in neighbors from throughout the community.

Starting with the parade Friday night, the Festival weekend offers a chance to flaunt Victorian finery, if you so desire. If you don't, sit back and marvel at the procession of people who do.

Once downtown streets close to traffic, the kickoff evening is an opportunity to leisurely visit with friends and family in a set-

### What do you think?

We welcome your Letter to the Editor. Please include your name, address and phone number for verification. We ask your letters be 400 words or less. We may edit for clarity, space and content. Letters to the Editor, David Aguilar, Northville Record, 104 W. Main St., Northville, MI 48167. Fax: (248) 349-9832. E-mail: daguilar@gannett.com.

ting replete with live entertainment, different taste sensations and assorted activities.

The backdrop is retailers celebrating the occasion with special displays and festival

enthusiasm.

It's not all authentic fashions and strait-laced behavior. Neighbors will share toe-tappin' bluegrass music and bourbon burgers, as well as dainty biscuits at parlor teas.

The parade, the rows of community organization booths, the Art Market and the full schedule of entertainment is a culmination of months of planning by volunteers. Behind the scenes, the Northville Chamber of Commerce and city staffs pull off the logistics so Northville can host its trademark celebration.

What's the hook of the Victorian Festival?

It's a chance to learn a little about our predecessors from another era. It's a chance to get reacquainted with Northville's unique downtown. And it's a time to stop the clock for a little while and have some fun.

See you there.



Photo courtesy of NINA BURKMAN

### Historically Speaking!

Unidentified, hat-wearing women gathered on a Northville porch, circa early 1900s.

## LETTERS

### Riding to the rescue!

The older I get, the more afraid I am of the capacity of human beings to inflict such evil in the world.

Shirley Phelps-Roper and her ilk (members of the Westboro Baptist Church in Topeka, Kansas) believe protesting at the private funeral services of U.S. servicemen is their right because "God spoke to America and issued a curse." This curse, according to Phelps-Roper, is that God is killing our soldiers in Iraq because of the United States' acceptance of homosexuality.

It's the stuff of bad science fiction, to think someone with a beating heart and an actual soul could dream up such an equation. Who are these people who call themselves Christians? What motivates a group to drive all over the country and disrupt the lives of families in their darkest hours?

Unfortunately, in today's world, religion has become the black cape worn by some to cover up ignorance and indifference. Fundamentalism and fanaticism fuel scary scenarios. We have only ourselves to blame when we turn the other cheek, and allow groups like this one to incite others and spew their hateful beliefs around the world, and in our own communities.

So thank you to the brave members of the Patriot Guard Riders who act as human shields, protecting Michigan's grieving families from these traveling zealots.

Larry Hesler, Ride Captain, told the Record they do it for the "fallen heroes." You, Mr. Hesler, and your volunteer group are our heroes for having the courage to do what is decent and kind.

Robin Gaines Franks  
Northville

### Truth about Devos

On August 5th, Jamie Turner wrote opining why he wasn't supporting Dick DeVos and wanted to convince the rest of us to do the same. His reasoning ostensibly was rooted in the fact DeVos had money and he and his family were somehow unworthy of holding public office. To support his argument he cited figures the family spent supporting the Republican party over the years. One has to wonder what Democrat Web site the numbers came from. I doubt Turner produced them from memory. Frankly, I find this Howard Dean type of attack a form of bigotry that is distasteful and as vile as racism and ethnic hatred. If you buy into this illogical thinking, then people like Kerry, Rockefeller, Kennedy and half the U.S. Senate should not be in office. And by the way, neither should Gov. John Corzine (D-New Jersey), who spent millions more than DeVos to get elected.

The 1,200 overseas jobs argument is phony and specious. It's an act of desperation to deflect voters attention from Granholm's record; or lack thereof. The ploy was tried early on in the campaign by Democratic Chair Mark Brewer, and was instantly discredited by editors, economists, and business leaders. When a firm's business begins to lose money, a logical consequence is to downsize much like the domestic auto companies have done. To do otherwise would be irresponsible. Besides, those so-called Chinese jobs were a result of starting a new venture for the Asian market, not a job transference.

Turner was also wrong when he stated DeVos refuses to offer his turnaround plan until after the election. If he were attentive, he would have seen the DeVos Web site advertised on TV wherein he details said plans. It aired about the same time Turner's letter was published.

As to the pot-shot at DeVos for criticizing

public education, DeVos is absolutely correct to do so. Our public education system is producing far too many functionally illiterate students. This pitiful performance is not a recent phenomenon; it's been going on for decades. As a further illustration of this point, a recent public report stated Michigan has 544 failing schools and is 49th in the nation in retaining college graduates. Not an enviable record. Granholm refuses to address the problem for fear of alienating her supporters in the education unions. I'm afraid our governor values image over substance.

Instead of trashing the DeVoses, I wish Turner had used his platform to tell us why we should vote for Granholm. I've looked at her performance over the last 3.5 years and found it lacking. From the vetoing of the establishment of a regional water board legislation, to the issuing her amicus brief supporting the U-M admissions quota system (when polls showed 65 percent against), her actions reflect a disregard for the suburbs and a decidedly pro Detroit mind set.

The state needs someone who has been in the trenches in the business world, who understands how to manage people, assets and budgets. Incumbency should not be an automatic path to re-election.

Ned Hart  
Northville

### COLUMN: JOEL THURTELL

## Scouting trout on the fly — in Northville

Trout in Wayne County?

In the Rouge River, allegedly the dirtiest in Michigan? It's true.

A veteran fly fisherman told me he could yank brown trout out of Johnson Creek any day of the week. Johnson Creek, in the city of Northville.

That's Wayne County, folks.

I could already smell fillets sizzling in a pan, but my expert got cold feet. Left me spinning my reels.

I fish, but not with flies. Fly-fishing always seemed a little, how to put it, upscale. Kind of highfalutin'. As a kid, I did my fishing on a western Michigan river and used worms or grubs.

But east of Napier Road, the Washtenaw-Wayne County line, you can't use live bait. I could have used spinners, but this story is about fly-fishing.

When my expert opted out, I knew of only one other local fly fisherman. He doesn't claim to be an expert, either. He normally blows through one of those big wooden sticks known as bassoons in the Detroit Symphony Orchestra. He's 56 years old, and long ago learned to fish with flies on mountain streams on his days off from the Colorado Symphony.

So I called Bob Williams. I was really smooth. Trout in Wayne County, I said, what an oxymoron. Right there in Northville, at Fish Hatchery Park half a mile from your house, Bob. Brown trout, some of them big enough to keep.

Now, that was a stretch. Each spring for the past dozen or so years, the Michigan Department of Natural Resources has planted about 4,500 one-year-old brown trout in Johnson Creek.

They're only 5-7 inches long, and because the river's shallow most of them die over the winter. Keepers have to be 12 inches long, and few grow that big.

But hey, trout are trout, right?

### Keeping it clean

The Johnson Creek Protection Group was formed to help preserve and protect Johnson Creek, which runs through the northwest corner of Plymouth Township, Salem Township, Northville Township and the city of Northville.

For more information on the group, visit online at [www.jcpg.org](http://www.jcpg.org).

Jeff Braunscheidel, a DNR fisheries biologist, and Demetria Janus, a biologist who's secretary of the Johnson Creek Preservation Association, told me why trout thrive there: They need cold water.

Johnson Creek is spring-fed, and it's covered by a tall canopy of oak, willow and maples that shades the little stream.

The creek is cool enough to support trout as far downstream as the Northville Downs racetrack, roughly where Johnson Creek empties into the Middle Rouge at Seven Mile and Sheldon.

If they swim farther downstream into Hines Park, they find warmer water and die.

But Johnson Creek also is threatened. Braunscheidel calls the Rouge Michigan's dirtiest river, and says it's because of human development — a combination over the years of farm and industrial waste and runoff from roads, parking lots, homes, stores, schools, factories. That's all coming to the Rouge's headwaters.

At Five Mile and Ridge, sediment, possibly from construction or farms, has covered the streambed.

Trout can't find food there, and consequently, Braunscheidel recently found "zero trout" there.

He wished me luck, but warned: "It's very difficult to fly-fish

Johnson Creek unless you're very good. There's lots of overhanging trees and brush. By the time you get in close enough to just flip a fly in, you're close enough to bug the trout."

I took all this bait to Bob Williams. The trout are there, I said. I'd never fished with flies, but who cares? He taught my younger son to play the bassoon. He could teach me to cast a fly.

"I'm no expert," he cautioned me. No problem; the fish are waiting.

We meet at 8:30 in the morning. It is a warm, clear day.

I borrow a pair of his chest waders and a pair of waterproof boots. Also, a fly rod and reel that cost him \$100 — so much for the upscale myth.

Northville's Fish Hatchery Park is on the south side of Seven Mile a bit east of Sheldon Road. You can see one of the old spring-fed hatchery ponds from Seven Mile. You can't see the creek, but that tall line of trees marks the curving path of the creek.

On a shady length of stream, my first lesson in casting. No lead weights, unlike bait-fishing.

The nylon line is tapered, heavier towards the fly end. The line's weight carries the fly where you want it. Supposedly.

Don't let out lots of line. A few feet is good. This surprises me. I've cast long distances fishing for bass, and trolling for pike I once had so much line out I got a ticket for fishing in the wrong state. Just kidding.

I tie a dry fly, a tiny bit of fuzz with a touch of black foam and a hook. Very light.

I watch Bob. Gracefully, he flicks the line in front and then behind him, backward and forward, a delicately dancing line that builds up speed until he lets it go.

The tiny fly flicks onto a ripply patch and floats. If a trout lurks

there, he's supposed to think that fake fly is breakfast.

I wag the rod, an English-made graphite wand a good eight feet long, and get some motion working back and forth. Oops. Something yanks back.

I've snagged the hook in an oak branch above my head.

More trouble: I loop my line around a stick lying in the muck behind me. This happens a few times, but oddly, it is not frustrating.

Upstream, Bob's line undulates over the stream. The trees and sticks leave him alone.

Water swirls around my feet. Very cool. That light wrist action, back and forth, back and forth, four or five times, building momentum and letting loose. So peaceful. So quiet. The rhythm is hypnotic. The sun is bright, but there's nice shade and a gentle breeze.

Bree pleasant! I could get into this.

Upstream, Bob calls: "Not so far back and forth."

I've got a pretty wild whip action. Snap out of the trance. Concentrate.

No bites. No sign of fish. What happened to those 4,500 trout the DNR stocked?

I call the DNR.

"I don't know what your problem is," Braunscheidel teases. Four days before we went fishing, he says, "we electro-shocked 80 trout there."

(Shock brings fish to the surface so it's used to help track and survey fish populations. The light electric current temporarily immobilizes fish, but doesn't hurt them.)

Hey, you've got a bright blue sky, cool breeze, fresh water murmuring around your feet, which remain dry.

And you get to wave this stick with a flashy yellow line and not feel silly.

Who needs fish?

## City: Thanks for your service

Last week, the City of Northville marked the passing of two of its former leaders, Malcolm "Mike" Allen and John Stubenvoll. In 1955, they sat on the council when the city was first incorporated, enabling a strong-management structure, the way the city does business still to this day. Political observer and former Northville Record publisher Bill Sliger aptly recalls the gravity of the decisions made by that first council, putting the city on the path of service and stability residents enjoy today. Thanks, Mr. Allen and Mr. Stubenvoll, for your vision and your service. Northville is proud to have known you — and better because of you.

## Schools: Keep talking contract

Teacher contract talks are expected to resume today between the district and the Northville Education Association. No extension was expected prior to today, meaning Northville teachers have been working without a contract since Sept. 1. Still both sides meet at the bargaining table, without strikes, court orders and public ousteries. Forward motion including setting the school calendar and times students will attend school are indicators both sides are working toward the best interest of students and parents. That's an effort we applaud.

# COMMENTARY

David Aguilar, editor (248) 349-1700, ext. 102 daguilar@gannett.com

## K-16 shell-game benefits school retirees, not kids

As you flip through the channels these days, you're likely to see ads featuring cherubic and hopeful faces in classrooms, with an announcer solemnly intoning phrases like, "we cannot compete in a global economy unless we dramatically improve education."



Phil Power

Sounds pretty good, doesn't it? It's an attempt to sell you on the so-called "K-16" initiative that will appear on the November ballot.

If passed, K-16 would require the State of Michigan to provide annual funding increases to match inflation to local public elementary, middle and high schools, intermediate school districts, community colleges and universities.

Early polls show solid support: 65 percent in favor, 25 percent opposed, 10 percent not sure.

But unfortunately, the amendment isn't really about teaching at all. Instead, it's mostly about requiring taxpayers to pick up the rapidly increasing costs of school employee pensions.

Called by its proper name, stripped of all the cynically misleading verbiage, K-16 really should be renamed "No school retiree left behind." And should this turkey pass, K-16 would have two extremely bad consequences for Michigan.

First, it would take the pressure off local school officials, school boards and local voters by shifting responsibility for tough financial decisions to the state government.

Second, most of the new dollars K-16 is supposed to produce for kids' education will be gobbled up by school employee pensions.

What we are really looking at is a shell game.

Yet it is one with a powerful come-on. The spin revolves around the superficially attractive idea that schools, community colleges and universities should be guaranteed annual increases equivalent to at least the inflation rate (now about 3 percent). The suggestion is

that the money will go to more teachers, smaller classes and so forth.

But that's not where most of it would go.

The biggest allocation comes from clever language that caps local districts' contributions to pensions for retired teachers and school employees. Mind you, it doesn't cap the pensions... Just what the local folks will have to pay.

Who pays for the uncapped increases in pension costs? The state, meaning you,

the taxpayer. Back in July, the Senate Fiscal Agency, the bean-counting arm of the state senate, estimated a first-year total price tag of \$566 million if the K-16 measure were approved. Of this, \$372 million (nearly two-thirds of the total) would go directly to school retirement funds. Nobody I've talked to, including supporters of the K-16 proposal, disputes this analysis, by the way.

The reason school boards, superintendents and teacher unions are so hell-bent on shifting so much of their local liabilities to the state is because costs of retiree health care and pension benefits are eating them alive. In 1991, the cost of school retiree pensions and health care equaled about 11 percent of school payrolls statewide.

Today, the retiree cost is 17 percent and growing rapidly. According to projections by the non-profit, non-partisan Citizens Research Council of Michigan, for every dollar paid to working school employees in 2020, the taxpayers will have to fork over 32 cents for retiree health care and pensions.

It's not as though this problem should have surprised anyone paying attention. Back in 2004, then-Michigan School Superintendent Tom Watkins warned the state Board of Education that "Combining increased pension contributions and health benefit costs for working employees leaves little room for increased spending directed to teaching and learning

even if the economy improves."

Citizens Research Council also suggested — fruitlessly, it turns out — a bunch of reforms at the local level that would help blunt the problem. These included lowering pension benefits for all new employees, greatly tightening costly early retirement benefits, increasing employee contributions for pension and health care and greatly tightening rules for retiree health care.

But nothing happened and the way it now stands, a Michigan school employee can work as few as five years to qualify for full health benefits upon retirement! Even the few retirement optimists at the United Auto Workers union, not to mention the automakers, would turn white at that kind of juicy perk.

In fact, even some of the proponents of K-16 admit in private that they never expected the measure to wind up on the ballot.

They figured they could put enough public pressure on the legislature and governor to get them to cave in without resorting to an initiative. Remember, they turned out nearly 12,000 demonstrators on the Capitol grounds for the purpose last June.

But neither Gov. Jennifer Granholm, nor the legislature buckled, if only because it would be terribly irresponsible to require unending, built-in inflation increases for anything, even education. So where this does leave us?

Only with the familiar, sickening feeling that once again, entrenched special interests are sneakily trying to snag public financing for a juicy perk, one that no private sector company can afford. And this time, they have the gall to pretend it's all for the kids.

For shame!

*Phil Power is a longtime observer of politics, economics and education issues in Michigan. He is also the founder of The Center for Michigan, a moderate think-and-do tank. These opinions and others expressed in his columns are his own and do not in any way represent official policy positions of The Center for Michigan. Phil would be pleased to hear from readers at ppower@hcnnet.com.*

### NORTHVILLE RECORD STAFF



Grace Perry - General Manager  
gperry@gannett.com  
(248) 349-1700, ext. 120



David Aguilar - Editor  
daguilar@gannett.com  
(248) 349-1700, ext. 102



Ed Fleming - Acct. Exec.  
efleming@gannett.com  
(248) 349-1700, ext. 118



Maureen Johnston - Staff Writer  
mjohnston@gannett.com  
(248) 349-1700, ext. 103



Victoria Mitchell - Staff Writer  
vemitchell@gannett.com  
(248) 349-1700, ext. 122



Renee Saunders - Staff Writer  
rsaunders@gannett.com  
(248) 349-1700, ext. 110



Jeff Theisen - Sports Writer  
jtheisen@gannett.com  
(248) 349-1700, ext. 104



John Heider - Staff Photographer  
jheider@gannett.com  
(248) 349-1700, ext. 106



Beth Hinman - Office Asst.  
bhinman@gannett.com  
(248) 349-1700



Margery Taurainen - Office Asst.  
mtaurainen@gannett.com  
(248) 349-1700

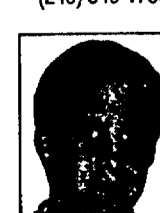

Billy Fraser - Graphic Designer  
bfraser@gannett.com  
(248) 349-1700, ext. 116

**Benjamin Franklin**  
THE PUNCTUAL PLUMBER.  
If there's any delay, it's you we pay!  
Up to a 2 year GUARANTEE on all repairs  
Phone answered live 24 hrs/day, 7 days a week

For all your **PLUMBING** needs, call...  
**MILFORD 248-348-0775**  
**SOUTH LYON 248-437-4887**  
**NOVI/NORTHVILLE 248-348-0775**  
**Toll Free: 866-867-5309**

**SPOTLIGHT ON:**  
**ALLERGY & ASTHMA**  
Presented by  
**Michael S. Rowe, M.D., F.A.C.P., C.C.R.I.**  
**OSTEOPOROSIS & ASTHMA**

Taking prednisone or other oral glucocorticosteroids (common medications for asthma patients) may increase a person's risk for developing osteoporosis. More than 25 million Americans live with this progressive, degenerative condition that leaves bones thinner and more fragile. Small bones in the back, wrists, pelvis, hips, and upper arms are most prone to fracture in people with osteoporosis. Many asthma patients take oral glucocorticosteroids to reduce their asthma-triggered inflammation and related symptoms. Over the long term, however, these medications can promote the development of osteoporosis. Inhaled glucocorticosteroids do not carry this risk and are also effective in treating inflammation. This is one reason why allergists generally will prescribe the lowest effective dose of oral glucocorticosteroids and recommend inhaled versions.

Today's column on asthma is of significant concern for women. Consult with Dr. Rowe, a Board certified allergist, at the ALLERGY & ASTHMA CENTER. The doctor can help you determine what triggers your asthma and how best to treat it. Call (248) 473-6400. Our office is located at 24120 Meadowbrook Road, STE 201, Novi. New patients are welcome. "The Caring Allergist Who Gets Results."

PS: Consuming sufficient amounts of calcium can help prevent osteoporosis or slow its progression.

**www.allergyinfo.org**

Proud to be a part of this great community

**O'BRIEN SULLIVAN**

FUNERALS, CREMATIONS, PREARRANGEMENTS

41555 Grand River Avenue  
Novi, Michigan 48375-1822  
(248)348-1800

John J. O'Brien      John P. O'Brien  
Michael D. Watt

State Licensed-Board Certified Funeral Directors  
Family owned  
[www.obriensullivanfuneralhome.com](http://www.obriensullivanfuneralhome.com)

**Offering Prearrangements & Prefinancing**

Now Offering Early Morning, Evening & Saturday Appointments

**Jeffrey Jaghab, D.D.S.**  
**Stephanie Jaghab, D.D.S.**

**General - Cosmetic Dentistry**  
Serving the Northville Community since 1949  
Voted Best Dental Office in Northville

**MEMBERS:**  
• American Dental Association • Michigan Dental Association  
• Detroit District Dental Association  
• Past Presidents of Detroit Dental Clinic Club  
• Pierre Fauchard Academy • Chicago Dental Society

416 South Main St. Northville  
248-349-2750  
[www.jaghab.com](http://www.jaghab.com)

**Rebecca Quilts**  
[www.rebeccaquilts.com](http://www.rebeccaquilts.com)  
248-374-3995

**HILLSIDE RAIDERS**

- T-shirt Quilts
- Basting for hand quilters
- Award winning longarm quilting
- Binding application
- Experience with antique quilt tops

**Congress shall make no law respecting an establishment of religion, or prohibiting the free exercise thereof; or abridging the freedom of speech, or of the press; or the right of the people peaceably to assemble, and to petition the government for a redress of grievances.**

*-First Amendment to the U.S. Constitution*

**For breaking news in Northville, click [www.northvillerecord.com](http://www.northvillerecord.com)**

**Letters to the Editor**  
We welcome your comments on editorials, columns and other topics important to you in the Northville Record. Only submissions that include name, address and day and evening phone numbers, and that are verified by the Northville Record, can be considered for publication.  
Letters to the editor of 400 or fewer words have the best chance of being published. All submissions may be edited for length, accuracy and clarity.  
Letters to the editor, opinion and editorial columns, and articles submitted to the Northville Record may be published or distributed in print, electronic or other forms. Letters to the Editor, David Aguilar, Northville Record, 104 W. Main St., Northville, MI 48167. Fax: (248) 349-9832. E-mail: [daguilar@gannett.com](mailto:daguilar@gannett.com).

# WHAT'S GOING ON?

## NORTHVILLE EVENTS

**GOLF OUTING**  
 DATE: Friday, Sept. 15  
 TIME: 8:00 a.m. Registration; 9:00 a.m. Shotgun Start  
 LOCATION: Northville Hills Golf Club, 15565 Bay Hill Drive  
 DETAILS: \$85 per player; Pre-registration required; Includes 18 holes of golf, continental breakfast, gourmet luncheon buffet, open bar, drawing which includes flat screen tv. Proceeds benefit ARMA Scholarship Fund.  
 CONTACT: Veronica Boyne (248) 355-0300 ext. 1405, or visit website www.armadetroit.org

**NORTHVILLE'S 20TH ANNUAL VICTORIAN FESTIVAL/ART MARKET**  
 DATE/TIME: Parade Friday, Sept. 15, 6:30 p.m.; Saturday, Sept. 16, 10 a.m.-7:30 p.m.; Sunday, Sept. 17, 11 a.m.-5:00 p.m.  
 LOCATION: Main Street, Northville  
 DETAILS: Weekend celebration including, art, games, rides, food booths, saloon, Eclipse Baseball, entertainment, Old Fashion Box Lunch Auction and more. Looking for volunteers!  
 CONTACT: Chamber Office (248) 349-7640, Art Market (248) 348-1845

**ART EXHIBIT**  
 LOCATION: Sherrus Gallery of Fine Art, 109 N. Center St.  
 CONTACT: (248) 380-0470  
 DATE: Sept. 1 - 30  
 DETAILS: "The Feminine Touch" exhibit will feature three Michigan artists

**ECLIPSE BASEBALL CLUB**  
 DATE: Home games are. Sept. 15-17  
 TIME: 1 p.m.  
 LOCATION: Ford Field, Mill Race Village  
 DETAILS: This is a group of Northville business men playing baseball, using rules from 1869.

**SOFTBALL TRYOUTS**  
 TIME/DATE: 10 a.m., Saturday, Sept. 16, and 4:00 p.m., Sunday, Sept. 17  
 LOCATION: Millennium Park  
 DETAILS: The tryouts are open to all girls that will be age 12 or under as of Dec. 31, 2006. Northville residency is not required. All positions are open, with a need for pitchers.

**NORTHVILLE HISTORICAL HOME TOUR**  
 DATE: Saturday, Sept. 16  
 TIME: 10 a.m.-4 p.m.  
 DETAILS: The Northville and Novi American Association of University Women will sponsor their annual home tour of homes in downtown Northville. Proceeds of ticket sales will help fund local college scholarships. Tickets will cost \$15, and can be purchased at Petite Maison, Pear-Aphanalia, Gardenviews, and the Northville Chamber of Commerce, or at the Cozy Cafe in Plymouth. To order tickets by phone, call (734) 204-1942.  
 CONTACT: (734) 207-1942

**NOVI CHORALAIRES AUDITIONS**  
 DATE: Tuesday, Sept. 19  
 TIME: 7:30-9:30 p.m.  
 LOCATION: Novi Middle School, 11 Mile and Wixom Road  
 DETAILS: The Novi Choralaires is a chorus with members from Novi, Northville and the surrounding area that performs in a number of holiday and local events. All voice parts are welcome to audition.  
 CONTACT: Dick Bayerl, President (248) 349-3267 or Janet Wassilak, Director (734) 449-2579

**ART EXHIBIT**  
 TIME/DATE: 4:30-8:30 p.m. Friday, Sept. 15; 9:30 a.m.-5 p.m. Saturday, Sept. 16; 11 a.m.-5 p.m. Sunday, Sept. 17  
 LOCATION: Northville Art House, 215 W. Cady St.  
 DETAILS: The Northville Camera Club will display "Favorite Images of 2006."  
 CONTACT: Laura Williams, (248) 349-3259 or e-mail LWilliams@twmi.rr.com

**ART HOUSE STORE GRAND OPENING**  
 DATE: Sept. 15

DETAILS: Come visit the newest addition at the Art House.  
 CONTACT: Northville Arts Commission (248) 449-9950

**ART WALK**  
 DATE: First Friday of every month  
 TIME: 5-9 p.m.  
 LOCATION: Downtown Northville  
 DETAILS: Art galleries, arts and crafts stores and restaurants will be open; art demonstrations and exhibits available in shops.  
 CONTACT: Tom James, Gallery of Fine Arts, (248) 349-0105

**PORTFOLIO PREPARATION CLASS**  
 DATE: Saturdays, Sept. 16 through Nov. 18  
 TIME: 9:30 a.m.-12:30 p.m.  
 LOCATION: First class will be at Awakening the Artist Inside, 111 N. Center St.; Remaining classes will held at the Northville Art House, 215 W. Cady St.  
 DETAILS: This class is to assist the serious art student in developing the design and composition skills in preparation of a portfolio that could be used to gain admission into art school. The instructor is Mary Ann Relyea. There is a course fee of \$275.  
 CONTACT: Robyn Mewha, (248) 347-0807

**NORTHVILLE NEWCOMERS AND NEIGHBORS "MEET AND GREET"**  
 DATE: Tuesday, Oct. 3  
 TIME: 10 a.m.  
 LOCATION: To be determined.  
 DETAILS: Members and guests are invited for socializing and information on the many activities the club has to offer.  
 CONTACT: Nancy Murphy, (248) 305-5460

**COLLEGE NIGHT**  
 DATE: Wednesday, Oct. 4  
 TIME: 6:30 p.m.  
 LOCATION: Schoolcraft Community College, Livonia Campus, Physical Education Building  
 DETAILS: Representative from approximately 65 colleges and universities will be available to answer questions on all aspects of attending their respective schools. This is event is open to the public, and is free.  
 CONTACT: Schoolcraft Office of Admissions, (734) 462-4426

**FARMERS MARKET**  
 DATE: Thursday through Oct. 26  
 TIME: 8 a.m.-3 p.m.  
 LOCATION: Northville Downs parking lot, corner of Seven Mile and Sheldon roads  
 DETAILS: More than 100 stalls include fresh produce, plants, flowers, baked goods, garden art, crafts and home accessories. This is sponsored by the Northville Chamber of Commerce and Prestwick Estates of Northville Hills Golf Club.  
 CONTACT: (248) 349-7640

**MARQUIS THEATER**  
 LOCATION: 135 E. Main St.  
 CONTACT: (248) 349-8110 or www.northvillemarquistheatre.com  
**Auditions for "Snow White and the Seven Dwarfs"**  
 DATE: Sunday, Sept. 24  
 TIME: 5 p.m.  
 DETAILS: Prepare a monologue or poem that is no longer than 90 seconds, or sing "Do-Re-Mi" from the "Sound of Music." An accompanist will be provided.  
**"Alice In Wonderland"**  
 DATE/TIME: Saturday, Sept. 16, 23, 2:30 p.m.; Sunday, Sept. 17, 24, 2:30 p.m.  
 DETAILS: Children ages 3 and under are not permitted. Tickets are \$8 per person.

**GENITTI'S LITTLE THEATER**  
 LOCATION: 108 E. Main St.  
 CONTACT: (248) 349-0522 or www.genittis.com  
**Dinner Theater - "Law and Disorder"**  
 DATE: Various days through mid-November  
 TIME: 6:30 p.m.  
 DETAILS: Tickets are \$45 per person for dinner and show. Registration is required.  
**Bob Posch and John Cionca**  
 DATE: Saturday, Sept. 23  
 TIME: 7 p.m.  
 DETAILS: Tickets are \$45 per



Photo courtesy Steve Elmore/Northville Township

With flags flying a half-staff, Northville Township personnel including fire and police staff observe a moment of silence Monday to commemorate the fifth anniversary of the Sept. 11, 2001 terrorist attacks on the United States.

**We remember!**  
 Northville Township firefighters join in a moment of reflection for rescue personnel who lost their lives on Sept. 11, 2001.

From left: Brian Siriani, Deputy Fire Chief David Carignan, Hugh Jordan, Rob McAllister, Jason Raschke, and Kyle Sasewitz.

Siriani reads a proclamation from the International Association of Firefighters, entitled "Day of Remembrance."



person for dinner and show. Registration is required.  
**"The Frank Sinatra Tribute from Las Vegas"**  
 DATE: Friday, Oct. 20; Saturday, Oct. 21  
 TIME: 7 p.m.  
 DETAILS: Tickets are \$45 per person for dinner and show. Registration is required.  
**Johnny Ginger**  
 DATE: Friday, Nov. 3  
 TIME: 7 p.m.  
 DETAILS: Tickets are \$35 per person for dinner and show. Registration is required.  
**The Reflections**  
 DATE: Saturday, Nov. 4  
 TIME: 7 p.m.  
 DETAILS: Tickets are \$45 per person. Registration is required.

**MAYBURY STATE PARK EVENTS**  
 LOCATION: Eight Mile Road, between Beck and Napier roads  
 CONTACT: (248) 349-8390  
**Sunday Family Series**  
 TIME: 6 p.m.  
 DETAILS: Sunday, Sept. 17 "All about Autumn"; Sept. 24 "Leaf Hike"  
**Baby Walk**  
 DATE: Sunday, Sept. 17  
 TIME: 12:45 p.m., check-in; 2 p.m. start  
 DETAILS: This walk is presented by M-CARE and proceeds will benefit the Tomorrow's Child Michigan SIDS. This is a non-profit organization aimed at reducing the risk of death for infants in Michigan.  
 CONTACT: Jan Quiring, Development Director, (800) 331-7437 or visit www.mibaby-walks.org

**Maybury History Trail**  
 DATE: Saturday, Sept. 30  
 TIME: 9 a.m.  
 DETAILS: This grand opening will include a ribbon-cutting ceremony and tours of the history trail, family activities and the annual Northville Road Runner Classic (8K run, 5K walk and one-mile fun walk.) The trail is self-guided, commemorating the people who lived and worked at Maybury Sanatorium. Proceeds will benefit the American Lung Association of Michigan and Friends of Maybury State Park.  
 CONTACT: George McCarthy, (248) 347-0899

**Maybury Farm Corn Maze**  
 DATE: Ongoing-Oct 29  
 TIME: Fridays 5-9 p.m.; Saturdays and Sundays 1-9 p.m.  
 DETAILS: Last Wagon leaves at 8 p.m.  
 CONTACT: Northville Community Foundation (248) 374-0200

**Maybury Farm Programs**  
 TIME/DATE: noon-5 p.m., Wednesday through Sunday  
 LOCATION: Eight Mile Road, west of Beck Road, look for the farm entrance sign  
 DETAILS: Admission is \$3 per adult and \$2 per child; children ages 3 and under are free.

CONTACT: (248) 374-0200  
**Hayride**  
 DETAILS: Hayrides are available on weekends or for groups pre-registered throughout the week.

**LIBRARY LINES**  
 LOCATION: 212 W. Cady St., near Northville City Hall; parking off Cady Street  
 TIME/DAY: 10 a.m.-9 p.m., Monday-Thursday; 10 a.m.-5 p.m., Friday-Saturday; and 1-5 p.m., Sunday  
 CONTACT: For information or to register for programs and request or renew library materials. (248) 349-3020

**September is Library Card Sign-Up Month**  
 Children who live in Northville City or Township, and are old enough to write their own name, can sign-up for their own library card. Children that sign-up will receive a surprise, and will be entered to win gift certificates from Barnes and Noble. Please sign-up at the Circulation Desk.

**Fall Tot Storytime**  
 Monday, Sept. 25 - Oct. 30, 10:15 a.m.  
 Wednesday, Sept. 27 - Nov. 1, 10:15 a.m.  
 Thursday, Sept. 28 - Nov. 2, 10:15 a.m.  
 DETAILS: This program is for children 2 and 3 years old accompanied by a parent or caregiver. Registration required, beginning Sept. 6. Sessions are limited to 13 children. Babies, siblings, or non-registered children may not attend.

**Fall Kids Club**  
 TIME/DATE: 4:15 - 5:15 p.m., Thursday, Sept. 28 - Dec. 7  
 DETAILS: This is an after school program for children in first, second, and third grades featuring stories, games, and crafts. Sessions are limited to 20 children. Registration is required.

**Little Me Storytime**  
 TIME/DATE: Fridays, Oct. 13, Nov. 10, Dec. 8, 10:30 - 11:15 a.m.  
 DETAILS: This is a program for babies and children up to 2 years of age, along with parents and caregivers, providing music, beanbag fun, and simple stories. Older children are welcome. No registration is required.

**The WhizzBang! Science Show**  
 TIME/DATE: 4:15 p.m., Today  
 DETAILS: Mike Hill will perform entertaining demonstrations to explore the world of science. This program is for children of all ages. 100 tickets

will be available at the Information Desk 5 minutes prior to the start of the program. Advance tickets will not be available.

**Book, Chat and Chow**  
 TIME/DATE: Wednesday, Sept. 27  
 DETAILS: This is a book group for children in Middle and High school. The book, "Inkheart" by Cornelia Fluke will be discussed. Registration is required.

**Junior Books, Chat and Chow**  
 TIME/DATE: 4:15 p.m., Wednesday, Sept. 27  
 DETAILS: This is a book group for children in fourth and fifth grades. The book, "Tale of Despereaux" by Kate DiCamillo, will be discussed. Registration is required.

**Fall Storytime**  
 Monday, Oct. 9 - Nov. 13, 4:00 p.m.  
 Tuesday, Oct. 10 - Nov. 14, 10:15 a.m.  
 DETAILS: This program is for children ages 4 and 5, and in Kindergarten, that are comfortable without a caregiver present. The program features stories and crafts. Sessions are limited to 20 children.  
 Registration is required.

**FRIENDS OF THE LIBRARY USED BOOK SALE**  
 DATE/TIME: Thursday, Sept. 21, 7-9 p.m.  
 DETAILS: Members Preview Night. Those buying a Friends membership will be eligible for the preview.  
 DATE/TIME: Friday, Sept. 22 and Saturday, Sept. 23, 10 a.m.-5 p.m.; Sunday, Sept. 24, 1-3 p.m.  
 DETAILS: This event will offer 12,000 books, CDs; DVDs, video tapes, and books on tape. Those wishing to donate books may do so at the Library. Home pick-up may be arranged by calling the Library.

**FRIENDS STORE**  
 DETAILS: The Friends Store, located inside the library, offers a variety of gifts for all ages. All proceeds benefit the library.

**BOOK DONATIONS**  
 DETAILS: Used books and materials are needed by the Friends of the Library. The library contributes to the collection and donates the rest to the Friends for sale, with proceeds benefiting the library. Donations are tax deductible. If you need assistance unloading books from your car, call (248) 349-3020 in advance to make arrangements.

**LIBRARY BOARD OF TRUSTEE MEETINGS**  
 DATE: Fourth Thursday of every month  
 TIME: 7:30 p.m.

## CHURCH EVENTS

**FIRST PRESBYTERIAN CHURCH OF NORTHVILLE**  
 LOCATION: 200 E. Main St.  
 CONTACT: (248) 349-0911  
**Single Place Events**  
 CONTACT: www.singleplace.org  
**Thursday Program-Ongoing**  
 TIME: 7:30, social; 8 p.m. program

DETAILS: The cost is \$5 per person.  
**Perfect Love, Imperfect Relationships, Part One**  
 DATE: Tonight  
 DETAILS: Robert Scanlan will discuss the book "Root Source of Relationship Problems".  
**Card and Games Night**  
 DATE: Tonight  
 DETAILS: Join others to play euchre, uno, and other board games.

**Always Ask the Question**  
 DATE: Sept. 21  
 DETAILS: Linda Settino Hurd will speak on nurturing a romantic relationship.  
**Perfect Love, Imperfect Relationships, Part Two**  
 DATE: Sept. 28  
 DETAILS: Robert Scanlan will discuss dealing with resentment in relationships.

**Card and Games Night**  
 DATE: Sept. 28  
 DETAILS: Join others to play euchre, uno, and other board games.  
**Walking Group**  
 TIME: 11:30 a.m.  
 LOCATION: First, second and fourth Saturday, Big Apple Bagel Shop, 2334 Farmington Road, Farmington; Third Saturday, Panera Bread Co., 34635 Grand River Ave., Farmington  
 DETAILS: This is a walking/social group. Everyone is invited.  
**20th Annual Juried Art Show**  
 DATE: Sept. 30-Oct. 6

**Victorian Teas**  
 DATE: Sept. 16  
 TIME: 2 p.m. and 3:30 p.m.

**DETROIT FIRST CHURCH OF THE NAZARENE**  
 LOCATION: 21260 Haggerty Rd.  
 CONTACT: (248) 348-7600  
**Ladies Bible Study**  
 DATE: Tuesdays through Nov. 14  
 TIME: 9:30 - 11:15 a.m.  
 DETAILS: The group will study book of Genesis. There is a \$15 registration fee that includes study materials. Free childcare is available for children 5 and under.  
 DATE: Tuesdays through Nov. 14  
 TIME: 6:45 - 8:15 p.m.



## WHAT'S GOING ON? (CONT'D)

continued from 16A

**DETAILS:** This will be the study of the patriarchs by Beth Moore. There is a \$20 registration fee that includes materials. There will be no childcare available.

### WARD EVANGELICAL PRESBYTERIAN CHURCH

LOCATION: 4000 Six Mile Road  
CONTACT: (248) 374-5966  
Remarried Workshop  
DATE: Wednesdays, through Dec. 13

TIME: 7-8:15 p.m.  
**DETAILS:** This free course will include information on blending families, parenting issues, communications and finances. Participants are welcome to attend one or all the classes

**Single Adults**  
DATE: Sunday  
TIME: 11:30 a.m.  
CONTACT: (248) 374-5920  
**College Age**  
DATE: Sunday  
TIME: 10:20 a.m.  
CONTACT: Mark Tarpinian, (248) 347-3525

### FIRST UNITED METHODIST CHURCH

LOCATION: 777 W. Eight Mile Road  
CONTACT: (248) 349-1144  
Summer Worship Services  
DETAILS: 8:30 and 10 a.m.  
Healing Service  
DATE: First Monday of every month

TIME: 4 p.m.  
**Grief Support Group**  
DATE: Fourth Monday of every month  
TIME: 7-8:30 p.m.  
**DETAILS:** New Hope Center for Grief Support is offering this support group to those who have lost a loved one to suicide. Registration is not required.  
CONTACT: New Hope Center for Grief Support, (248) 348-0115 or www.newhopecenter.net

## SENIOR EVENTS

Thursday, Sept. 14  
9 a.m.: Taking Off Pounds Sensibly  
9:30 a.m.: Yoga  
11 a.m.: Dementia Series

12:30 p.m.: Pinochle  
1 p.m.: Tai Chi  
By appointment: Massage  
Friday, Sept. 15  
10 a.m.: Strength Training  
11 a.m.: Poker  
11 a.m.: Issues of Care Giving  
1 p.m.: Movie -The Sentinel  
Monday, Sept. 18  
10 a.m.: Line Dance  
10 a.m.: Oxygise  
11 a.m.: Oxygise, New

**Enrollees**  
12:30 p.m.: Pinochle/Euchre  
By appointment: Chair Massage  
Tuesday, Sept. 19  
12:30 p.m.: Pinochle  
Wednesday, Sept. 20  
9 a.m.: Strength Training  
10 a.m.: Mackinac Trip Meeting  
10 a.m.: Oxygise  
11 a.m.: Oxygise New Enrollees  
noon: Bridge  
Dining to Donate at Applebee's

**BOARD GAMES**  
DATE: Tuesday, ongoing  
TIME: 1 p.m.  
LOCATION: Senior Community Center, 303 W. Main St.  
CONTACT: (248) 349-4140

**ONGOING CARD GAMES**  
Bridge  
TIME/DAY: noon-3:30 p.m., Wednesday  
Pinochle (double deck)  
TIME/DAY: 12:30-4:30 p.m., Monday and Thursday  
Pinochle (single deck)  
TIME/DAY: 12:30-3:30 p.m., Friday  
Euchre  
TIME/DAY: 12:30 p.m., Monday  
LOCATION: Senior Community Center, 303 W. Main St.

**HEALTH WALKING**  
DATE: Monday-Friday  
TIME: 8-10 a.m.  
LOCATION: Senior Community Center gym, 303 W. Main St.

**YOGA CLASS**  
DATE: Sept. 11-Nov. 30, Mondays and Thursdays.  
TIME: 5:30-6:45 p.m. and 7-8:30 p.m. on Mondays; 9:30-11 a.m., 5:20-6:45 p.m. and 7-8:30 p.m. on Thursdays  
LOCATION: American Legion Hall; Thursday morning at Northville Senior Center  
DETAILS: No class Oct. 2 and Nov. 23. Please do not park in Casterline lot. Monday evenings,

Yoga II for continuing students. Make-ups allowed in Legion Hall classes through Nov. 30. Fall Session \$88. Unregistered student drop-in rate \$11. Extra classes for registered students \$ 7.50. Scholarships available. Start anytime. No charge for first class.  
CONTACT: Diane Siegel-DiVita (248) 344-0928 or trianglesix@sbcglobal.net

## MILL RACE MATTERS

**MILL RACE HISTORICAL VILLAGE**  
LOCATION: 215 Griswold Avenue, north of Main Street, near Ford Field  
CONTACT: (248) 348-1845  
Today: Archives open, 9 a.m. Friday: Northville Public Schools, 8 a.m.; Archives open, 9 a.m.; Rehearsal, 5 p.m.; Eclipse Baseball, 6 p.m.  
Saturday: Eclipse Baseball, noon; Victorian Festival, 1-4 p.m.; \*Wedding, 4:30-6:30 p.m.  
Sunday: Mill Creek Church, 10 a.m.; Village Open, 1-4 p.m.; Victorian Festival, 1-4 p.m.; Rug Hookers, 1 p.m.; Eclipse Baseball, 4 p.m.  
Monday: Cub Scouts, 6:30 p.m.  
Tuesday: Stone Gang, 9 a.m.; Weavers Guild, 7:30 p.m.  
Wednesday: Private Tour, 12:45 p.m.; Mindfulness Meditation, 6:45 p.m.  
\*Grounds closed to the Public

## LOOKING FOR YOU

**NORTHVILLE NEWCOMERS AND NEIGHBORS**  
DETAILS: This group is for residents of Northville and surrounding communities. Activities include monthly coffees, various interest groups and special programs. New and potential members are welcome.  
CONTACT: Nancy Murphy, (248) 305-5460

**BABY WALK VOLUNTEERS**  
DETAILS: The non-profit statewide organization, "Tomorrow's Child, Michigan Sudden Infant Death Syndrome,"



### Vote for me!

Republican gubernatorial candidate Dick DeVos briefly visited the Sunrise Assisted Living at Northville last week to meet and talk to residents. Township Clerk Sue Hillebrand said she will be bringing applications for absentee ballots to the seniors before the end of this month.

Photo by JOHN HEIDER/Northville Record

needs volunteers to serve as team captains for the second annual Baby Walk. The walk will be Sept. 17 at Maybury State Park. Team captains will recruit friends and family to participate. Teams are collecting pledges for Sudden

Infant Death Syndrome research.  
CONTACT: Carol, (248) 650-3729 or visit www.tomorrow-childmi.org

**OAKWOOD CEMETERY WALK**  
DETAILS: The cemetery walk will

feature historical information about the people that shaped Northville, and will take place on Sunday, Oct. 8, from 5-9 p.m. Volunteers are needed as tour leaders, ticket sellers, ticket tak-

continued on 18A

## Put Yourself In Our Shoes

Clearwater & Its Island Beaches

www.visitclearwaterflorida.com Toll Free 888-425-3279

**Why visit for less?** Enjoy the quiet luxury of Clearwater Beach's favorite highway resort. Kitchens and in-room balconies available. 37-00 private marina. Heated pool and beach. Ask about our select pet-friendly rooms.

**Chart House Suites on Clearwater Bay**  
677-CHART 99  
www.charthousesuites.com

**"Red Beach on Gulf of Mexico"** Natural marine water attractions, minutes from Orlando. Vacation packages available. In-line Free Visitor Guide.

**Clearwater Regional Chamber of Commerce**  
227-461-0011  
www.clearwaterflorida.org

Located across the street from world famous Clearwater Beach, adjacent to Clearwater Marina. Near Pier 60, restaurants and attractions.

**Port Vue Hotel**  
227-460-7929  
www.portvue.com

Discover family-friendly fun and great value in the heart of Clearwater Beach, featuring Jimmy Guan's Gulf Front Fish House.

**Clearwater Beach Golfview Resort**  
727-447-6451  
www.cwbbeachresort.com

Located on the white sandy beaches of the Gulf of Mexico, offering 425 guest rooms and 100+ 2 beachside pools, waterfront restaurant, Kid's Fun Factory, and much more.

**Hilton Clearwater Beach Resort**  
800-253-3954  
www.hiltonclearwaterbeachresort.com

Florida's Beach is home to Fort De Soto Park, rated America's #1 Beach. Contact us for a free visitor's guide.

**St. Petersburg-Clearwater Area Convention and Visitors Bureau**  
877-352-3224 • FloridaBeach.com

A luxury vacation rental and corporate housing company offering first class resort amenities and lifestyles.

**Clearwater Cay Club**  
888-737-2595  
www.waterclubs.com

Unique Key West style waterfront resort and marina just steps away from the beach. "Where the fun never sets!"

**Holiday Inn Hotel & Suites - HarbourSide**  
www.hiharbourside.com

Escape to our island paradise and find over 500 vacation condos and homes to choose from on the beautiful white sandy beaches of Tampa Bay.

**Travel Resort Condominiums**  
800-237-4556  
www.trscnc.com

TRY SOMETHING NEW- SPEND YOUR MONEY WHEN YOU GET THERE!

Fly USA3000 Airlines  
To St. Petersburg/Clearwater

1-877-USA-3000 | www.usa3000.com



# Want to Feel Great? Join the Club.

## The First Medical Fitness Center in Your Community!

A Variety of Group Classes Available,  
Including Tai Chi, Yoga and Pilates.

For More Information, Call 248 473-3100



39750 Grand River Avenue Novi, MI 48375 • www.botsford.org/bchi

## SATURN GOES WILD AT THE DETROIT ZOO



NOW'S YOUR CHANCE TO WIN A 2007 SATURN SKY  
RAFFLE TICKETS ARE ONLY \$25 EACH

Bypass the waiting lists and be one of the first to experience Saturn's most sought after 2007 vehicle. Proceeds benefit the Detroit Zoo, a place that has brought nature and community together for more than 78 years.

**DETROIT ZOO** The drawing will be held October 16, 2006, at noon, at the Detroit Zoo. You need not be present to win. Winner will be notified.

Donated by: Detroit Area Saturn Retailers

Like nowhere else. 2007 Saturn SKY estimated MSRP with destination is approximately \$25,000.

Entry forms must be received by September 30, 2006 to qualify.

I WOULD LIKE TO ORDER \_\_\_\_\_ RAFFLE TICKET(S). TOTAL AMOUNT ENCLOSED \$ \_\_\_\_\_

NAME: \_\_\_\_\_

ADDRESS: \_\_\_\_\_

CITY: \_\_\_\_\_ STATE: \_\_\_\_\_ ZIP: \_\_\_\_\_

TELEPHONE: \_\_\_\_\_ E-MAIL ADDRESS: \_\_\_\_\_

CHECK ENCLOSED: PAYABLE TO DETROIT ZOOLOGICAL SOCIETY

PLEASE CHARGE TO MY:  VISA  MASTERCARD  AMEX  DISCOVER

ACCOUNT NO: \_\_\_\_\_ EXP. DATE: \_\_\_\_\_

SIGNATURE: \_\_\_\_\_

We accept phone, fax, mail and internet orders: Detroit Zoological Society • 8450 W Ten Mile Rd • Royal Oak, MI 48067  
Ph. 248.541.5717 Ext. 3750 • Fax. 248.541.2489 • www.detroitzoo.org

Winner of the 2007 Saturn SKY must be at least 18 years of age, and a legal resident of the United States. Delivery of the vehicle will be arranged through a Detroit Area Saturn Retailer. Winner agrees to be responsible for all taxes, licensing fees, dealer fees, title fees and other fees associated with ownership of the vehicle, including withholding/IRS tax. The 2007 Saturn SKY is non-transferable, non-exchangeable and non-refundable. A different GM model cannot be substituted for the 2007 Saturn SKY. GM is not responsible for the cost of any optional equipment above the specified MSRP. Equipment that is not available directly from GM (factory ordered options) are not available. Optional equipment of this type, and any associated payment, must be coordinated directly between the winner and the delivering dealer. This vehicle is not eligible for GM incentives of any type or GMAC vehicle financing. Actual vehicle awarded may differ from vehicle pictured or on display. Tickets are \$25 each. Winning ticket will be drawn at the Detroit Zoo. Need not be present to win. Purchase of raffle ticket is not tax deductible. MI Raffle License #R87057. For more information, call 248 541 5717 Ext. 3750 or visit www.detroitzoo.org. Sponsored by The Detroit Zoological Society

## WHAT'S GOING ON? (CONT'D)

continued from 17A

ers, greeters, set-up crew, and clean-up crew.  
**CONTACT:** Barbara, (734) 454-4287, or CemetaryWalk2006@yahoo.com

**MENTOR VOLUNTEERS**  
**DETAILS:** The Oakland County Youth Assistance is looking for volunteers for their Mentor Plus program. Training and orientation sessions will be held at the Oakland County Courthouse, 1200 N. Telegraph Rd., Pontiac.  
**DATE/TIME:** Saturday, Sept. 16, 9 a.m.; Saturday, Oct. 14, 9 a.m.; Tuesday, Oct. 17, 6 p.m.; Saturday, Nov. 11, 9 a.m.; Saturday, Dec. 9, 9 a.m.  
**CONTACT:** (248) 858-0041

**YWCA OF WESTERN WAYNE COUNTY**  
**DETAILS:** The YWCA is looking for volunteers to assist with office help, after-school programs, building projects, communications, and marketing in its various locations throughout western Wayne County. They are also offering internships for college students in communications, media relations, and computer information service. Additional opportunities are available in early childhood education, and education administration.  
**CONTACT:** Tabatha Manuel.

(313) 561-4110, ext. 20, or e-mail at tmanuel@ywca-www.org

**MEALS-ON-WHEELS**  
**DATE:** Ongoing  
**TIME:** 11 a.m.-12:30 p.m.  
**DETAILS:** Permanent and substitute drivers are needed.  
**CONTACT:** Eileen at Allen Terrace, (248) 231-9950, 10 a.m.-1 p.m., Monday through Friday or Judy LaManna, (248) 348-1761

**CAMERA CLUB**  
**DATE:** Second Tuesday of every month  
**CONTACT:** Tom James of Northville Camera at northville-camera@sbcglobal.net, or Northville Arts Commission, (248) 449-9950

**ARTS COMMISSION**  
**DATE:** Second Wednesday of every month  
**TIME:** 7:30 p.m.  
**LOCATION:** Art House, 215 W. Cady St.

**BEAUTIFICATION COMMISSION**  
**DATE:** Second Tuesday of every month  
**TIME:** 7 p.m.  
**LOCATION:** Northville City Hall, 215 W. Main St., Meeting Room B

**HOUSING COMMISSION**  
**DATE:** Second Wednesday of

every month  
**TIME:** 3 p.m.  
**LOCATION:** Allen Terrace, 401 High St.

**YOUTH ASSISTANCE**  
**DATE:** Second Tuesday of every month  
**TIME:** 8 a.m.  
**LOCATION:** Youth Assistance office, 775 N. Center St.  
**CONTACT:** (248) 344-1618

**PARKS AND RECREATION COMMISSION**  
**DATE:** Second Wednesday of every month  
**TIME:** 7 p.m.  
**LOCATION:** Senior Community Center, 303 W. Main St.

**PARKS AND RECREATION ACTIVITIES**  
**LOCATION:** 775 N. Center St., back entrance of Hillside Middle School  
**CONTACT:** For registration and information on camps, classes and activities, (248) 349-0203 or visit [www.northvilleparksandrec.org](http://www.northvilleparksandrec.org)

**VOLLEYBALL SKILLS CLINIC**  
**DATE:** Sundays, Sept. 10-Oct. 1

continued on 19A



Submitted Photo

### Sweet beginnings!

The staff and owners of the Northville Schokolad Chocolate Factory celebrate their Sept. 7 grand opening with a ribbon cutting ceremony.

## SIDING WORLD HOMEOWNERS WELCOME!

**CertainTeed & Wolverine VINYL In Stock!**

<p><b>VINYL SIDING</b>  <b>SALE \$46.95</b>  <small>Colors + \$3.00</small></p> <p><b>ALUMINUM COIL STOCK</b>  <b>\$62.95</b>  <small>24" x 30" ft. White Colors Available</small></p> <p><b>VINYL SOFFIT</b>  <b>\$48.50</b>  <small>FOR OVERHANGS</small></p> <p><b>CUSTOM TRIM AVAILABLE</b>  <small>Bring in your measurements and we will custom form your trim</small></p>	<p><b>SIDING WORLD'S WINDOW SHOWROOM</b>  <small>DISTRIBUTORS FOR:</small>  </p> <p><b>SEAMLESS GUTTERS</b>  <b>6" GUTTER \$1.59</b>  <b>5" GUTTER \$1.05</b>  <small>Per Foot 0.02 Gauge</small></p> <p><b>GUTTER LEAF GUARDS</b>  <b>MANY TYPES IN STOCK!</b>  <small>COLORS AVAILABLE</small></p>
--	--

**LIVONIA**  
 3025 W. Eight Mile Rd.  
 (1/2 Mi. West of Middlebelt)  
**248-478-8884**

MT. CLEMENS	DETROIT	CLIO	RADISSON HTS.	WYANDOTTE	ANN ARBOR	WALLED LAKE	WATERFORD
4740 Zeeb Rd. #2700 588-8888	5000 Spivey Rd. #200 313-8888	1700 E. Grand St. 810-8888	327 Beaubien St. 248-8888	7315 Lewis Rd. 734-8888	3022 Woodland 734-8888	1120 South Road 248-8888	5000 W. Main St. 248-8888
588-7800	881-2802	687-4730	685-8050	284-7171	728-0400	824-8808	674-1300

FOR ADDITIONAL LOCATIONS  
[www.sidingworld.com](http://www.sidingworld.com)



time to come in for a  

# Spin!



## Spin & Win Rockin' Prizes!

August 14 – September 28

The house is rockin' at MGM Grand! Take a front row seat as the MGM Grand Prize Patrol gives away Backstage Passes to spin the wheel of Rock 'n' Roll Riches. It's a rockin' good time at MGM Grand!

- 🎵 Score Cash, FreePlay and super cool MGM Grand swag!
- 🎵 Play your favorite slots and table games for your chance to spin at random!
- 🎵 Spin and win every Monday – Thursday from Noon – 8pm!

### Rockin' The Cash Out!

See Players Club for details.

For more information call 1-877-888-2121 or visit us online at: [www.mgmgranddetroit.com](http://www.mgmgranddetroit.com)  
 1300 John C. Lodge, Detroit, MI 48226, Lodge (M-10) South, exit Bagley or Howard

**MGM GRAND**  
 DETROIT CASINO  
 Where the City Shines.



**TELCOM CREDIT UNION**  
 YOU BELONG HERE!

SPONSORS THE 1ST

# Grapes & Grooves

A WINE TASTING, FEATURING STROLLING APPETIZERS FROM LOCAL RESTAURANTS, jazz by The Keith Kaminski Trio, AND A SILENT AUCTION WITH WONDERFUL ITEMS.

**Date:** Friday, September 29, 2006  
**Time:** 6:30pm - 10:00pm  
**Place:** Novi's MainStreet Atrium  
 43115 MainStreet: S. of I-96 and E. off Novi Rd.  
**Price:** \$30 prior to event. \$40 at the door

Brought To You By: **AND THE MAINSTREET MERCHANTS!**

**GREATER NOVI CHAMBER**

**RSVP:**  
 Whitney McClellan  
 EXECUTIVE DIRECTOR,  
 GREATER NOVI CHAMBER  
 248-347-4622  
[wmgccc@yahoo.com](mailto:wmgccc@yahoo.com)

[www.seven7graphics.com](http://www.seven7graphics.com)

**Novi News Northville Record**  
 Proud to Sponsor the First Grapes & Grooves Event!

## WHAT'S GOING ON? (CONT'D)

continued from 18A

**TIME:** 12-2 p.m. for Elementary and Middle School; 2-4 p.m. for High School  
**LOCATION:** Recreation Center at Hillside

**DETAILS:** Help improve overall volleyball skills, any level; Camp Director, Tom Teeters, Schoolcraft College Head Coach; Fee \$100 for resident, additional fee for non-resident.

### LACROSSE CLINIC FOR BOYS AND GIRLS

**DATE:** Saturdays, Sept. 9-30  
**TIME:** 9-10:30 a.m. for Boys; 10:30-12 p.m. for Girls  
**LOCATION:** Maybury State Park Lacrosse Field

**DETAILS:** Coaches David Herbert and Jacob Kaufman welcome all to learn the exciting game of lacrosse. Players will be divided based on skill level. Beginners learn to pass, shoot, scoop, cradle, and basic rules of the game. Advanced players focus on technique and game practice. Equipment needed: Lacrosse stick and mouth guard for girls and beginner boys; Lacrosse stick, mouth guard, helmet, gloves and pads for advanced boys. Fee \$25 for resident, additional fee for non-resident.

### FALL YOUTH BASKETBALL

**DATE:** Saturday, Nov. 4-Dec. 16

**DETAILS:** Registration begins Tuesday through Sept. 15 or until leagues are full. The girls league is for grades fourth-sixth; boys leagues are for grades fourth-fifth and sixth-seventh. Practice will be held one-two times per week beginning Oct. 23.

**CONTACT:** (248) 349-0203, extension #1405

### ADULT COACHES NEEDED

**DETAILS:** Coaches are needed for Northville Parks and Recreation's youth basketball leagues. Your child will play for free if you volunteer to be a head coach.

**CONTACT:** Dave DeMattos, (248) 349-0203, extension #1405

### WOMEN'S NETBALL

**DATE:** Friday, ongoing

**TIME:** 7-9 p.m.

**LOCATION:** Senior Community Center, 303 W. Main St.

**DETAILS:** Netball is a game from Britain based loosely on basketball rules.

**CONTACT:** (248) 449-9947

### FIRST, SECOND, AND THIRD GRADE INSTRUCTIONAL BASKETBALL

**DATE:** Tuesdays, Sept. 26-Nov. 7

**TIME:** 1st-2nd Grade, 4:30-5:15 p.m.; 3rd Grade, 5:30-6:15pm

**LOCATION:** Northville Senior Community Center

**DETAILS:** Kids will get a chance to learn basketball skills, play scrimmage games, have fun without competition! Bring your friends and have a blast! Includes T-Shirt. Fee \$65 for resident, additional fee for non-resident. No class Oct. 31.

### OPEN BASKETBALL

**DATE:** Every Sunday

**TIME:** 6-9 p.m.

**LOCATION:** Senior Community Center, 303 W. Main St.

**DETAILS:** The fee is \$3 per person.

### OPEN BASKETBALL, 40 AND OVER

**DATE:** Wednesday, Sept. 20-Oct. 18

**TIME:** 8-10 p.m.

**LOCATION:** Senior Community Center

**DETAILS:** The fee is \$3 per person.

### OPEN BASKETBALL, WOMEN ONLY

**DATE:** Tuesday, Sept. 18-Dec. 19

**TIME:** 7-9:30 p.m.

**LOCATION:** Senior Community Center

**DETAILS:** The fee is \$3 per person.

### OPEN VOLLEYBALL

**TIME/DATE:** 7-10 p.m., every Thursday; 10 a.m.-2 p.m., Saturdays, Sept.-April

**LOCATION:** Recreation Center at Hillside

**DETAILS:** There is a fee of \$3 per person for Thursday, and \$4 per person for Saturday.

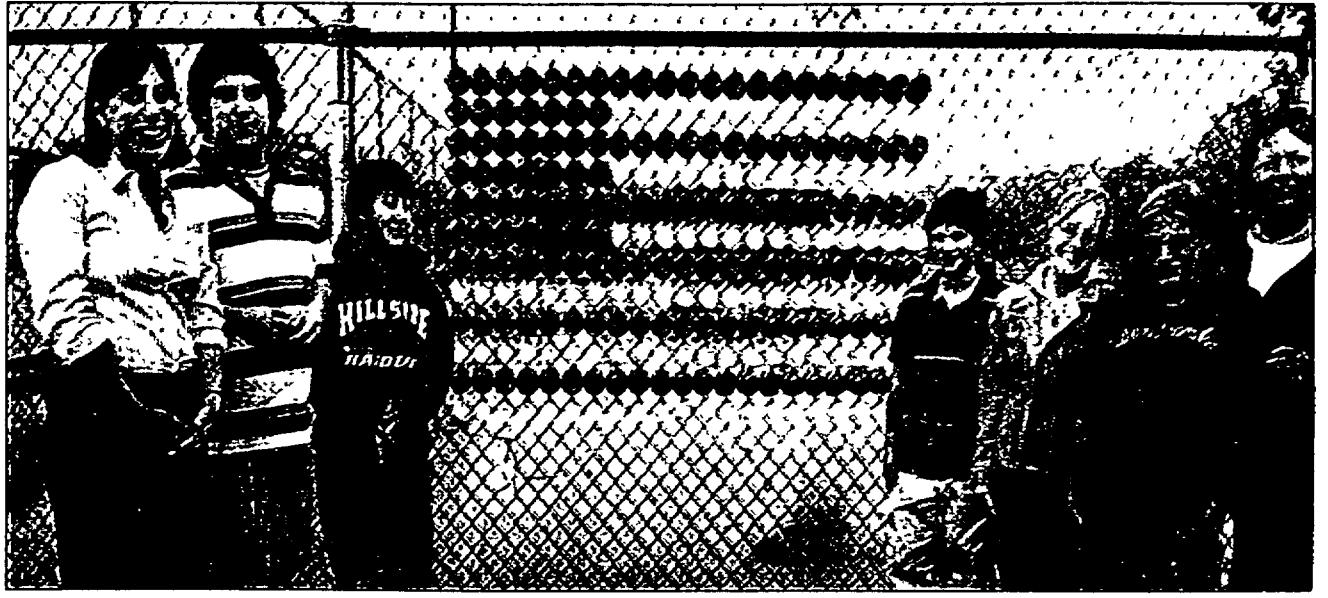

Photo by JOHN HEIDER/Northville Record

### Paying tribute!

To honor the solemn occasion of Sept. 11, Christina Mavian's Hillside class created an American Flag out of plastic cups along the fence line at the school's tennis courts. From left: Mavian, Cody Mullins, Joe Miklos, Vincent Govan, Brooke Anderson, Paige Thurman and teacher-assistant Leslie Ryder.

**Charter One**  
 Not your typical bank.®

# Itching for a better Home Equity Rate? Scratch here.

Visit any Charter One branch to try your luck.

Every card saves you interest on a new Home Equity Loan or Line.

15 Grand Prizes of 0% APR on a new Home Equity Loan.

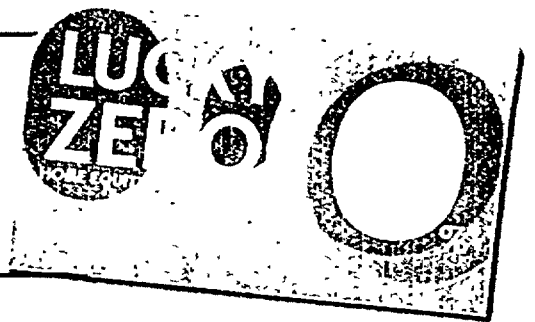

Come to any Charter One branch today to enter the Charter One Lucky Zero Home Equity Sweepstakes. Every card saves you money because you get interest off your Home Equity Loan or Line. Yes, every card. So you can't lose. Then just mail in your card and you'll have a chance at one of the 15 Grand Prizes of 0% APR interest on a Home Equity Loan. But you have to hurry because the Lucky Zero Home Equity Sweepstakes won't be going on forever. Besides, when you have an itch, you just have to scratch.

See a banker for details and Official Rules. No purchase or application necessary. Open to legal U.S. residents residing in CT, RI, VT, NH, PA, DE, NY, NJ, OH, MA, MI, ME, IL, IN or KY who are 18 years of age or older. Void where prohibited. All accounts subject to individual approval. Maximum value of interest paid is \$30,000. Other restrictions apply. Visit a participating branch for Official Rules. Sweepstakes ends 9/22/06. Mail your completed entry by 9/22/06, to Citizens Bank/Charter One Bank 0% Interest Loan Sweepstakes, PO Box 7948, Melville, NY 11775-7948. Equal Housing Lender.

## Are you an organ & tissue donor?

Ask your family today, and let them know your decision, too. That way you'll know, they'll know, and there will be no question later.

For a free brochure, call 1-800-355-SHARE.

Share your life. share your decision.™

Michigan Coalition on donation



Submitted Photo

### Check up!

Elizabeth Strong, left, of the M.O.M.S organization presents a \$1,000 check to Barbara Glassen of the First Step Womens Shelter.

**BUSCH'S**  
 Fresh. Food. Ideas.

PRICES EFFECTIVE THROUGH SUNDAY, SEPTEMBER 17, 2006.



**\$4.99 lb.**  
 NATURALLY AGED WHOLE BEEF TENDERLOIN



**BUY 1, GET 1 Free!**  
 BUSCH'S GRADE A LARGE EGGS DOZEN



**BUY 1, GET 1 Free!**  
 EDY'S ICE CREAM ALL VARIETIES 56 OZ.



**BUY 1, GET 1 Free!**  
 PROGRESSO SOUP, 18.5-19 OZ. SELECTED VARIETIES EXCLUDES RICH & HEARTY

WWW.BUSCHS.COM

OUR GUESTS AGREE! BUSCH'S IS SOUTHEASTERN MICHIGAN'S *Sweetest* GROCERY STORE!

# Spotlight on Business

**Triple Play Sale!**  
Suits, Sport Coats, Slacks  
Buy one, get second item  
**50% Off**  
105 East Main Street  
248-349-5097

**ADELSON EYE & LASER CENTER**  
LASER VISION CORRECTION

**Main Street BANK**  
201 E. Main Street  
Northville  
248-449-3700  
www.mainstreetbank.net

**FARM BUREAU INSURANCE**  
MICHIGAN'S INSURANCE COMPANY  
Recent rate reductions  
for home & auto insurance  
Jeffrey Beitz Agency  
137 South Center St.  
248.344.9112

**DAVIS AUTO CARE**  
Integrity  
Is The Difference  
807 Doheny Dr  
248-349-5115  
www.davisautocare.com

248-474-9362  
www.nailprinting.com  
**Nail Printing**  
Specializing in:  
Wedding Invitations  
Personalized Holiday  
Greetings



Regina Abraham, Shaun Abraham & Jackie Riley welcome you to The New Taurus Cafe located inside Studio 427 - Regina Abraham Gallery

## The new popular gathering spot!

With a new espresso and smoothie bar, Studio 427 is becoming a popular gathering place in downtown Northville. Frozen strawberry and mango smoothies or an iced cappuccino are perfect on a warm fall day. And regulars are starting to stop in for an early morning or after dinner coffee. There's always something tasty on hand with bagels and muffins from Detroit Bagel Factory and cookies from Queen of Sweets.

Stepping into Studio 427 awakens all of the senses. It is filled with a mixture of fine art like water lily oil paintings and functional urban art. With a cement floor and exposed ceiling, it's a comfortable space with room to breathe.

On Friday nights the studio and cafe is loud, filled with the sound of local bands. And it's one stop on the First Friday Art Walk. In a couple weeks the studio will come alive with new rhythms as salsa lessons start up.

Studio 427 is filled with unique objects, from tables made out of wheels to lizards made from found objects like wrenches. "As an artist and designer myself I have a personal passion for functional design and architectural pieces, where a blend of form and function meets art," said owner Regina Abraham. "It is a way to incorporate art into your daily environment beyond traditional paintings and sculptures."

Wall art celebrates the metropolitan culture with photos of Woodward Avenue matted with metals found in closed down factories. Other artwork features photo montages of the people and places of Detroit on paper or concrete. Other framed pieces celebrate the Tigers and local sports history.

Bob Seger records shaped into bowls, or bags made from local newspapers make affordable gifts. Clocks made from brake discs or belts made from Mustang seat belts bring art into everyday living. "I specialize in unique gifts and rare hand-made items that can't be found anywhere else," said Abraham. "And they are things that are actually affordable, with a lot of gifts under \$50."

The studio also carries hand-crafted jewelry, glassware, hand-painted paper lamps, 2007 planners and unusual greeting cards. The artwork is constantly changing, with a new show each month. Abraham first open Studio 427 in an old church several blocks away. The gallery moved to its Main Street location less than a year ago. So far the community has embraced the studio in its new home, making it a regular gathering place.

Studio 427 is also gaining popularity as a place for private parties. Abraham can bring in a band or string quartet with a custom menu. She's hosted memorable events such as birthday parties, corporate affairs, bachelorette and retirement parties.

"This is a great place to celebrate a special occasion with beautiful, artistic surroundings," Abraham said.

Visit Studio 427 and the Taurus Cafe for a quick drink or an afternoon of relaxation. Hours are Monday through Wednesday 7 a.m. to 6 p.m., Thursday 7 a.m. to 7 p.m., Friday 7 a.m. to 9:30 p.m. and Saturday 8 a.m. to 5 p.m. The studio is located at 122 West Main Street in downtown Northville. For more details call (248) 449-6501 or go to www.studio427.net.

**ALEXANDER'S CUSTOM CLOTHIERS**  
248-349-6080  
124 W. Main

Espresso's, Lattes, Frozen Fruit Smoothies, Iced Tea & Baked Goods  
**Taurus cafe**  
Located inside STUDIO 427 @ 122 W. Main

**\$10.00 Off Dinner for Two**  
with purchase of \$25 or more.  
**BISTRO 427**  
127 E. Lake St.  
South Lyon  
248-437-9000

**Tiramisu**  
Excite your senses  
146 S Center  
248.735.0101

**THE HOLE IN THE WALL**  
108 East Main St.  
248-349-0522  
www.genittis.com

**Northville Curves**  
30 minute workout designed for women!  
It's fun, fast and safe, you'll love the support and encouragement and it WORKS!!  
43261 Seven Mile Rd.  
East of Northville Road  
Call us at 248.344.4466

**FREE VENUE**  
of your choice with purchase of Go Kart ticket  
**Paradise Park**  
43799 Grand River Ave. • Novi  
www.paradisepark.com  
248.735.1050

**Maid Brigade**  
YOUR HOME CLEANER  
**\$30 Off**  
Initial Cleaning  
Call for Free Estimate  
248.449.4493  
www.maidbrigade.com

# MILL: If you're going to do it, do it right

continued from 1A

intersects Griswold Street. Don't look for orchards — they're long gone. Now Michigan apples are trucked in; varieties depending on the quality. "That's why our season is when it is," Jones said. "We're always looking for the best apple we can get."

**Don't like cider?** Northville's cider mill has grown into a series of fudge, nut, cider and snack huts, including the Chow Mill, serving hot-dogs and kielbasa on the weekends.

Picnic tables are nestled among shade trees and the yard is full of play structures for young climbers.

**There might be a line** Of course, there's going to be



a wait on Saturday and Sunday. "On a nice weekend, we are swamped," Jones said. "Sometimes the line is longer. "We're working as fast as we can."

**Weekdays are an option** Julie Stalla of Northville and Lynne Mrozek of Livonia shared a picnic table during day off work last week, sipping cider slush, crunching caramel apples and shoeing bees. Stalla is a Parmenter's regular during the mill's three-month season; slush during the week, donuts on the weekend

**Start a tradition** For Lynne Mrozek, her mill visit was a special occasion, like when she was a kid.

"I used to live in Dearborn, so it was an outing," she said. "It was coming out in the country. It was a lot of fun."

Jones said customers tell the counter staff they're there for the first time and they've been coming 35 years.

"We have young ones come here, seniors, people who come in here and say, 'My grandpa used to bring me here,'" she said. "We have kids who say, **LEFT: Mel Jones watches as a batch of crushed apples enters the mill's cider press.**

**BELOW: Parmenter's Northville Cider Mill on Baseline Rd.**

**Parmenter's Northville Cider Mill**  
 714 Baseline Road  
 10 am-8 pm  
 7 Days thru October  
 10 am-7 pm  
 November  
 (248) 349-3181



"Next year, I'll be old enough to work here." "For a lot of people, it truly is a tradition."

**Watch the staff hustle** For the Nelson and Jones families, Labor Day weekend means the start of 10-12 hour days. The compressed season means hustling, long days, Jones said, punctuated by to-do list additions for the off-season. "There's no other life for Cheryl, Rob, my husband and me," Jones said. "It's always, 'Do we have enough of what we need?' "It's 20 hours a day of energy."

**Don't just eat and run ...** On the weekend, crafters set up in the yard, selling jewelry and sweatshirts to parents of children riding the wooden train or climbing on play structures. Don't forget to ask for "duck donuts" to feed feathered visitors along the water's edge. "I think people on the weekend — they spend sometimes an hour," Jones said. "Some people just come in and go because that's what they come in for — cider and donuts."

**Check out 'The Favorites'** Parmenter's Northville Cider Mill co-owner Diane Jones said top-sellers are the cider, donuts, caramel apples, nuts, fudge and, for the past six years, the slush. "If you're coming in, you're most commonly going to buy those things," she said.

**Got a buck?** "Kids come in after school and buy two donuts and a pint (of cider) or two donuts and a slush. "If your mom gave you a buck, you're going over to the candy counter figuring out how many things you can get."

**Are you lovin' it?** Jones said wage and fuel costs have impacted prices at the mill, with a cider half gallon and six donuts at \$7 and a gallon and a dozen at \$12. "We try to absorb it when we can," she said. "We still want it to be a family place — it's still a pretty reasonable outing. "For 12 bucks, I'm not sure you're going to be able to feed



Photos by JOHN HEIDER/Northville Record  
**Barbara Williams, 13-year Parmenter's employee, grabs a handful of sugar-spiced donuts.**

everyone at McDonalds."

**They seem familiar** Like the cider fans approaching the counters, the workforce comes in family droves. Even if they're not blood-related, tenure at the mill binds them, said Barbara Williams, who has stuffed green and white bags with spice and plain donuts for 13 years.

In addition to owner couples Cheryl and Rob Nelson and Diane and Mel Jones, other relatives include sisters KC Kidder who makes donuts and fudge with her husband, Joe, and Debbie and Stephanie Abner, who run the Nut Mill.

**It's a three-month window** Once the doors open Labor

Day weekend, the clock is ticking until November. The mill will close the Sunday before Thanksgiving.

**Take in the aromas** Diversions in the yard are one tactic to lessen the wait, Jones said. Cheerful staff is another. Jones smiles when she looks at the parking lot and sees 10 vans in a row, because it means parents with children. "Hopefully, they'll be treated well and have some of the best cider and donuts they'll ever have."

Mawreen Johnston can be reached at (248) 349-1700, ext. 103, or via e-mail at mjohnston@gannett.com

**DOORS CLOSE "7 P.M." SATURDAY**

# FINAL STORE CLOSING PHASE

**THE END OF AN ERA!** After many years we are closing our doors forever. Our entire stock of showroom & warehouse inventory must be sold and removed from the building immediately. Hundreds of thousands of dollars worth of furniture and bedding will be offered to the public at prices far below what you would expect to pay. Don't miss it!

**TIME IS RUNNING OUT!** We are announcing the final phase of this event. Time is running out, don't delay. This is your once in a lifetime opportunity to buy name brand furniture and bedding at near or below cost. All offers considered. Please be patient, you should expect very large crowds. Be prepared to make a quick decision.

<b>BE EARLY</b> ALL REMAINING LAMP'S ADDITIONAL <b>50% OFF</b> Lowest Ticket Price	<b>GREAT BUY</b> ALL REMAINING ACCESSORIES ADDITIONAL <b>50% OFF</b> Lowest Ticket Price	<b>GREAT BUY</b> ALL REMAINING AREA RUGS ADDITIONAL <b>50% OFF</b> Lowest Ticket Price	<b>ALL MUST GO!!</b> <b>ORDERED SOLD SATURDAY</b> Saturday 10am - 7pm financing available	<b>SAVE!</b> BASSETT SOFAS & LOVESEATS & CHAIRS UP TO <b>75% OFF</b>	<b>WOW!</b> BASSETT BEDROOM FURNITURE UP TO <b>75% OFF</b>	<b>BE EARLY!</b> SUPER LUXURY SLEEPSETS <b>70% OFF</b>
--	--	--	---	---	---	---

**NAME BRANDS AT SALVAGE PRICES** Prices have been slashed! Everything is priced to sell on a go! Cost has been completely forgotten. You'll want to be early and you'll want to bring the crowds. Thursday in order to get your share while the action is at it's best. Be near the doors when they open Thursday morning. Convent terms are late with 10% or no money down or see your Visa, Mastercard, American Express or Discover.

**RULES OF LIQUIDATION**

- All advertised items subject to prior sale!
- All sold as is and all sales are final!
- Extra charge for delivery!
- Be patient, you should expect very large crowds!
- No phone orders - no prior sales!
- Merchandise must be removed immediately!

**BRING YOUR TRUCKS AND TRAILERS**

<b>FULL SIZE MATTRESS &amp; BOX SPRING AT LIQUIDATION PRICES WHILE THEY LAST</b>	<b>6 PIECE BEDROOM</b> Dresser, Mirror, Chest, 2 Bed, Night Stand <b>\$2,988</b>	<b>COCKTAIL &amp; END TABLES UP TO 75% OFF</b>	<b>RECLINING SOFA LOVESEAT &amp; CHAIR 1/2 OFF</b>	<b>LEATHER SOFA LOVESEAT &amp; CHAIR \$1990</b>	<b>"BE EARLY!" SOFA, CHAIR &amp; LOVESEAT \$498</b>	<b>"BE QUICK!" 5 PIECE DINETTE \$388</b>
<b>PUB STYLE 5 PC. DINETTE 1/2 OFF</b>	<b>4 PIECE BEDROOM 50% OFF</b>	<b>TUB CHAIRS YOUR CHOICE OF STYLE \$119</b>	<b>DON'T MISS BASSETT SOFA AND LOVESEAT \$1,098</b>	<b>ORPHAN CHAIRS CASUAL FORMAL \$49</b>	<b>"CHERRY" ENTERTAINMENT CENTER \$398</b>	<b>"WOW!" SLEIGH BED \$897</b>
<b>"GREAT BUY!" COCKTAIL TABLE &amp; 2 END TABLES \$98</b>	<b>BASSETT ENTERTAINMENT UNITS 1/2 OFF</b>	<b>"BE EARLY!" SOFA AND LOVESEAT \$699</b>	<b>"QUEEN ANNE CHERRY" 8 PIECE DINING ROOM \$1,988</b>	<b>CHOOSE FROM LIVING ROOM BEDROOM OCCASIONAL LEATHER &amp; MUCH MORE</b>	<b>TWIN SIZE MATTRESS &amp; FOUNDATION DEALERS WELCOME \$198</b>	<b>"BEAR!" CURIO \$198</b>

**Bassett FURNITURE DIRECT**  
 4050 E. Grand River Ave. Howell, MI 48843

**STORE HOURS:**  
 THURSDAY 10 TO 8PM  
 FRIDAY 10 TO 7PM  
 SATURDAY 10 TO 7PM

Member FDIC

This term's too long.  
 This term's too short.  
 This term's *juuuuuust* right.

You choose the term — anywhere from 30 days to 10 years — and earn the same great rate. Now that's convenience!

Introducing the "Pick Your Term" CD

**5.40%** APY\*  
 With "Loyalty Checking Account"

**5.15%** APY\*  
 Without "Loyalty Checking Account"

Ask about our Loyal Money Market Account!

Convenience you can count on. **Flagstar Bank**

(800) 642-0039 www.flagstar.com

\*Annual Percentage Yield (APY) on the 30-day Certificate of Deposit (CD) through the 10-year CD is accurate as of 8/30/06. Customers without a "Loyalty Checking Account" will receive the Valued Customer rate of 5.15% APY on the 30-day CD through the 10-year CD. Minimum opening balance is \$500 and maximum deposit is \$100,000. Penalty may be imposed for early withdrawal. Not available for public units. Account fees could reduce earnings. Offer applies only to new accounts. Neither existing accounts nor accounts opened under the program will automatically renew at these special rates, contact your banking center for details. Other restrictions may apply. \*Customer must maintain an open and active checking account at Flagstar Bank with at least one automatic, recurring transaction monthly to qualify. "Loyalty Checking Account" rate offer cannot be combined with coupons or other special offers.

# WHAT'S GOING ON? (CONT'D)

continued from 19A

**Coach Floyd's Excel Basketball Skills Clinic**  
 DATE: Sept. 24-Oct. 29  
 TIME: 2-4 p.m.  
 LOCATION: Northville Senior Community Center  
 DETAILS: This clinic teaches the fundamentals of basketball to youth, grades 4-7. Beginner players learn dribbling, passing, shooting, and other basics of basketball; Intermediate players learn how to play their position more effectively by enhancing skills. We teach all players confidence in their game. Every player deserves attention from our friendly, experienced, patient Excel instructors. Every player walks away knowing the "Science of Basketball." Fee \$100 for resident, additional fee for non-resident.

**OPEN BADMINTON**  
 DATE: Every Tuesday and Friday  
 TIME: 7-9:30 p.m.  
 LOCATION: Hillside Recreation Center, 700 W. Baseline Road  
 DETAILS: Competitive style badminton is available. All skill levels are welcome. The cost is \$7 per night.

**TABLE TENNIS**  
 TIME/DAY: 6-10 p.m., Monday and noon-4 p.m., Saturday  
 LOCATION: Hillside Recreation Center, 700 W. Baseline Road  
 DETAILS: Eight tables are available. All skill levels are welcome. The cost is \$4 per day.

## REGIONAL

**CLASS REUNION**  
 DATE: Saturday, Sept. 23  
 TIME: 6 p.m.  
 LOCATION: Aboard the Detroit Princess Riverboat  
 DETAILS: This is the John Glenn High School Class of 1981 reunion.  
 CONTACT: Lisa Cockrum Baker, (248) 360-8253 or Janice Fritz Ryken, (248) 838-9864

**SEMINAR ON LOVE-THE KEY TO OUR HEARTS**  
 DATE: Tuesday, Oct. 3

TIME: 7-8:30p.m.  
 LOCATION: Longacre House, 24705 Farmington Road, Farmington Hills  
 DETAILS: This is a presentation by Joan Marie Stenerson on love, with open discussion on "What was the happiest day of your life?" The seminar is free, and all are welcome.

**RUMMAGE AND BAKE SALE**  
 DATE: Saturday, Oct. 14  
 TIME: 8 a.m.-2 p.m.  
 LOCATION: Catholic Central High School, 27225 Wixom Road, Wixom  
 DETAILS: There will be a \$1 bag sale at 1 p.m.

**CLASS REUNION**  
 DATE: Saturday, Oct. 14  
 TIME: 5 p.m.  
 LOCATION: Polish Legion of American Veterans, Dearborn Heights Post 16, 25222 Warren, Dearborn Heights  
 DETAILS: This event is for the St. Hedwig Class of 1956 and 1957.  
 CONTACT: Rose Marie Kucharski, (734) 420-2163

**FRIENDS OF THE ROUGE FALL BUG HUNT**  
 DATE: Saturday, Oct. 14  
 TIME: 9 a.m.-3 p.m.  
 LOCATION: Schoolcraft

College's VistaTech Center  
 DETAILS: Volunteers are needed to help with obtaining samples of the small forms of aquatic life found in the streambed of the Rouge River. No prior experience is necessary. Children are welcome if accompanied by an adult, and groups are limited to six. Pre-registration is necessary.  
 CONTACT: (313) 792-9621

**GRIEF SUPPORT WORKSHOP**  
 DATE: Mondays, Oct. 9-Nov. 27  
 TIME: 7-8:45 p.m.  
 LOCATION: Our Lady of Good Counsel Catholic Church, 47650 N. Territorial Road, Plymouth  
 DETAILS: Cathy Clough, Director of the New Center for Grief Support, will present this workshop for those dealing with grief and loss. The sessions are open to the community, and are free.  
 CONTACT: (734) 459-0326, ext. 221

**ANGELA HOSPICE GROUPS**  
 DETAILS: Grief support groups include general grief, loss of a spouse, women's grief, heartstrings: parents who have lost a child and a grief support quilter's group. All groups are led by bereavement professionals and trained volunteers.

LOCATION: Angela Hospice Care Center, 14100 Newburgh Road, Livonia  
 CONTACT: Joan Lee, (734) 953-6012

**MASTER GARDENER ASSOCIATION**  
 DAY: Second Thursday of every month  
 TIME: 7 p.m.  
 DETAILS: Meet at the Environmental Interpretive Center at the northwest corner of the University of Michigan-Dearborn campus, 4901 Evergreen Road, between Ford Road and Michigan Avenue.

**PARK PASS**  
 DETAILS: Metroparks and Oakland County Parks are offering a dual park pass. The annual cost is \$43 and can be purchased at any park office.  
 CONTACT: (800) 477-3178 or www.metroparks.com

**CRAFT SHOW**  
 DETAILS: South Lyon United Methodist Church on Pontiac Trail, is looking for participants for this Nov. 4 event. The cost is \$35 per booth.  
 CONTACT: Barb, (248) 437-0385 or Carol, (248) 437-2112



Submitted Photo

**Splashdown!**  
 Brendan Hicks enjoyed time spent playing in the puddles Aug. 27 following the championship Northville U8 Allstar Baseball Tournament game.



Because affordable health care is our mission.

Floors To Your Door



By: Mike Riley



### Long-Term Carpet Care

For carpet to retain its luster and beauty for years to come, have it professionally cleaned every one to two years. Deep cleaning removes and dissolves soil that regular home cleanings can't. More importantly, by not having your carpet professionally cleaned, a restorative method may be required to bring your carpet back to its most presentable possible condition. Worse yet, you run the risk of causing irreparable damage. If that isn't convincing enough, most carpet manufacturers' stain warranties require hot water extraction cleaning every two years, otherwise the warranty becomes invalid due to improper maintenance.

When your carpet is deep cleaned, be sure to remove as much furniture as possible. For pieces that can't be moved, place plastic or aluminum foil under furniture legs to prevent rust and stains. Allow the carpet to dry completely before walking on it. To speed up the drying process, ventilate the room with fans, and open windows. Help is nearby. For answers to your questions on how cleaning and maintenance affect your carpet's long-term performance, consult your warranty, or call your carpet retailer. Most fiber and carpet manufacturers provide toll-free help lines.

**Laurel's**  
 MOBILE DESIGN CENTER  
 810-227-4577  
 248-640-3397  
 website laurelsflooring.com

Because Michigan is our home.  
 Contact your agent or visit [bcbsm.com/individual](http://bcbsm.com/individual).

  **Blue Cross Blue Shield of Michigan**  
 Michigan's most trusted name in health care.  
[bcbsm.com/individual](http://bcbsm.com/individual)



# Golf team edges rival Novi

Coverage, Photo Page, 4B

# SPORTS

# B-1

NORTHVILLE RECORD

northvillerecord.com

Thursday, September 14, 2006

## Don't forget to enjoy sports

### Sept. 11 puts perspective on crazy sports scene

By Jeff Theisen  
RECORD STAFF WRITER

Don't ever forget. Every Sept. 11, for the rest of my life, I'm going to remember the day where everything changed.

Very few things changed for the better, but they've certainly changed.

I love sports, probably to the point of sickness. I have changed dates of things to do with family and friends because of sporting events.

I love every-thing about sports.

I think it's the ultimate way to show talent. It's the ultimate arena to display a whole skill. One person or team who shouldn't win does, not because they are better, but because they wouldn't let themselves lose.

Rooting for the underdog is great when the little Chihuahua beats the Doberman.

Seeing kids and athletes step up and perform at their best on the biggest of stages is a wonderful and thrilling thing to watch.

I'm not sure what else I would want to do with my life for a job more than what I do.

On Sept. 11, 2001, I was on my way to apply for a job in something other than sports writing.

I almost didn't get into the business that I now know and love.

The horrible day that happened made me rethink things.

I was going to be a sports writer, no matter what. I was going to write, because that was what I really wanted to do. So many people died that day, and if they hadn't already, would never get the chance to do something they really wanted to.

Continued on 3B



Jeff Theisen

# CONTINUED IMPROVEMENT

## Mustangs look to even record against Wayne Zebras

By Jeff Theisen  
RECORD STAFF WRITER

Friday's game pitting Northville against Wayne Zebras will be a battle of two teams smarting from Friday night losses.

Northville battled with Western Lakes foe Walled Lake Western but came out on the short end of a 34-23 decision.

The Zebras (1-2) came up a point shy against Livonia Franklin, 20-19.

"We feel like we did a lot of things well that we can build on," Northville head coach Ryan Hockman said. "Obviously, we've got to get better in a very quick amount of time tackling."

"We're getting better. You can see the difference between us and last year."

The standout player on film according to Hockman is Howell's quarterback.

"They have a real good athlete at quarterback, David Freeman, a second-year starter," Hockman said. "They'll get him in the shotgun and move him around, he can throw the ball. He's not a pocket passer, but he can throw it. He's slippery and he's quick and a strong kid."

"You can play good, good, good for 20 plays, and then he'll take one on you."

Containment and responsibilities will be keys to the Mustang defense.

"Our defensive ends have got to play. You can't get too far upfield on (Freeman)," Hockman said.

Hockman said the Zebras also have a standout player on defense.

"They've got a real good linebacker. He is a 6-foot, 220 pounder," Hockman said. "They're big up front on both sides of the ball."

Keeping control of the ball on offense will be the focus on offense. Hockman expects to get Ditrick Williams the ball more than he did against Walled Lake Western.

"We didn't get him the ball this last week as we had been. We were probably 55 percent pass this past week," Hockman said. "We had six guys catch passes last week."

Jeff Theisen can be reached at (248) 349-1700, ext. 104 or at [jtheisen@gannett.com](mailto:jtheisen@gannett.com).

## Friday's Game:

Who: Northville (1-2) at Wayne Memorial (1-2)

Where: Away

When: 7 p.m. Friday

Coach quote: "We feel like we did a lot of things well that we can build on (last week). Obviously, we've got to get better in a very quick amount of time tackling."

"We're getting better. You can see the difference between us and last year."



Photo by JOHN HEIDER/Northville Record

Mustang Aaron Chew takes off for the endzone on a 72-yard reception from quarterback Mike Deluca on Friday against Walled Lake Western.

# Go-ahead TD gets called back

## Mustangs lose 34-23 to WL Western

By Jeff Theisen  
RECORD STAFF WRITER

Northville thought it had a 29-27 lead in the fourth quarter against Walled Lake Western on Friday. Instead, a holding penalty called back the go-ahead touchdown by Ditrick Williams, and the Warriors went on to win 34-23.

"It was a hold they called on the right tackle," Hockman said. "The play was run to the left and was already about 15 yards downfield. It's hard to say what he saw."

"That would've put us up 30-27 with the extra point."

But Hockman didn't blame the call for the loss. His team had a chance to hold after a punt but couldn't do it.

"You're going to have moments like that," he said. "You've still got to continue to play. If we get a stop, we get the ball back with a chance to win the game."

The loss was tough to take, but it let Hockman and his team know they can play with the big boys.

"That tells our kids that you've got the ability to do it," Hockman said. "We just have to put four quarters, play hard and concentrate for 48 minutes and believe we can win those games."

"Walled Lake Western is a good football team."

Mike DeLuca put up solid numbers that could've been much better.

"We had six drops," Hockman said. "That's something that we have to make. I think we threw the ball more than they thought we would."

DeLuca still finished 13-for-29 for 209 yards and one score.

Ditrick Williams again held the bulk of the carries, gaining 94

Continued on 3B

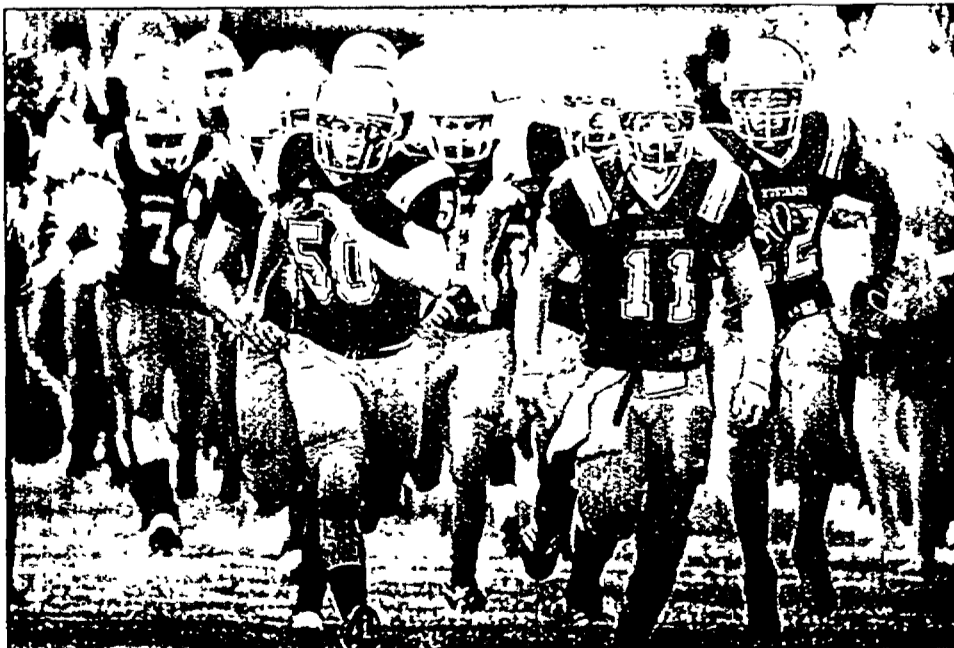

Photo by JOHN HEIDER/Northville Record

Mustang seniors Jon Pace, Mike Deluca and Ditrick Williams lead their teammates onto the field Friday before their game against Walled Lake Western.

## Toning down the hype

### Mustang soccer will let play do the talking

By Susan Smiley  
GANNETT NEWS SERVICE

The Northville Mustangs boys varsity soccer players are not necessarily the biggest "American Idol" fans. But the seasoned players know this much about the popular singing contest program — they don't want to be like Chris Daughtry.

Daughtry was an early favorite in the contest, and many predicted he would win it all. Instead, he was ousted two weeks before the season finale.

Last year, Northville was a favorite to advance to the state final. The Mustangs put together a stellar regular season in 2005, before being upset in the district final by an upstart Dearborn team.

To see the joy of the Dearborn team was wonderful, but I wish they did not have to win at our expense," Northville coach Henry Klimes said.

"That was where this team was 10 years ago when we were the underdog. We're not the underdog anymore, but we can't forget what it takes to win."

Once again, in 2006, the Mustangs began their season being touted as a formidable team that should make a run at a state title.

Continued on 2B



## Find what you're looking for in the Green Sheet Classifieds Call 1-888-999-1288



Submitted photo

**Northville's #1!**

The Northville varsity pom pon team won the Grand Champs trophy and Most Improved Advanced Level team award at the 2006 Mid-American Pom Pon Camp at Northwood University.

**Sports Shorts**

**Northville Pom Pon Clinic**

The Northville High School Varsity Pom Pon captains Lauren Bishop, Kristen deBear, Heather Quick, Ali Evasic and Erica Hagan and the rest of the varsity team will hold a clinic for sixth through eighth grade girls.

The clinic runs 6-7:30 p.m. Monday to Thursday, Oct. 9-12 at the Northville auxiliary gym. Participants will perform at half-time of the Oct. 13 Northville varsity football game.

**Motor City Madness Tryout**

Motor City Madness is hosting a tryout for girls fast pitch softball for the 2006-07 season Sept. 17. The schedule is 9-11 a.m. for

10-under, 11 a.m. to 1 p.m. for 12-under and 1-3 p.m. for 14-under.

Arrive 15 minutes early to sign-in at Power Park, located off of 10 mile between Taft and Novi Road behind the Novi Civic Center.

Team tryouts are based age as of Dec. 31, 2006.

For more information, please call Chris Lawler at (248) 735-1893 or email at clawler@tw.mi.tt.com.

**Oakland County Junior Wheelchair basketball team**

The Junior Thunderbirds Wheelchair Basketball Team begins its 2006-2007 season September 13 at Beech Woods Recreation Center in Southfield.

Youths with a physical impairment in high school or younger are invited to join now, no experience necessary.

Players must be able to propel a manual wheelchair. Practices are on Wednesdays from 6:30-8:30 p.m.

The Junior Thunderbirds are sponsored by Oakland County Parks and Southfield Parks and Recreation.

To register or for additional information, call Sandy Dorey at (248) 858-7596 or assistant coach Claudia Brewer at (248) 796-4673.

**Mustang Soccer: Less talk, more action**

Continued from 1B

Northville's 8-0-1 start, after Monday's 3-1 win against Walled Lake Western, indicates that those preseason predictions may not be too far off track. But players have learned they cannot believe everything they read.

This year, the Mustangs are trying to tone down the hype — at least in the Northville locker room — and just pay attention to the job at hand.

The regular season, they know all too well, doesn't mean a thing if success isn't sustained through the entire playoffs.

"In years past, we've come into the season ranked No. 1 or No. 2 in the state," senior forward and co-captain Jonathon Junca said.

"We would go on MLIVE (a running preps blog) and do a lot of talking about how good we were. We are not going to do that this year."

Junca recalls a game last season where, after talking themselves up on the Internet, the Mustangs ended up in a 2-2 tie with Walled Lake Western.

This season it is going to be a lot less talk and a little more action where the Mustangs are concerned.

"We are just trying to keep everyone on an even keel," Klimes said.

"We don't want to get too high after a win or too low after a loss. We just want to keep building to get stronger throughout the season so that we are ready for the playoffs. It's been kind of different this year because we played

six games before school even started. At the same time, we had really only had four solid practices."

As corny as it sounds, senior co-captain and midfielder Alex Wood says he believes if he and the other captains can foster strong team chemistry, the Mustangs will be able to make a longer playoff run this year.

Instead of everyone being out for themselves and worrying about their own stats, Wood, Junca, and captains Chris Leonetti and Ryan Burdette are promoting an "all for one and one for all" attitude.

"We are having team dinners, team sleepovers and just hanging out a lot when we aren't on the field," Wood said.

"We did team dinners in the past, but it would be like all of the seniors would be hanging around talking in one group and the new people were in another group, and no one really interacted. Now as the captains, we make an effort to make sure everyone is talking to each other."

At practice too, the seniors make sure to draw players back in who seem to be straying from the fold. They also take the time to work skills drills with everyone — not just the other seniors.

After all, it is the entire team

— not just the seniors — which has a target on its back every time it takes the field. Because despite that loss in the playoffs last year, people still expect the Mustangs to fare well this season.

"I think I feel even more pressure this year," Junca said. "We are seniors and, for us, this is the last chance to win."

Klimes, too, is trying to do his part to be as low key as possible about his team's early success this season. Recently, he called in a score to the local newspaper and simply gave the facts — who scored, how many saves his keeper made, and the like. When the story came out the next day, splashed across the top of the page was a headline reading "NORTHVILLE STAYS UNDEFEATED."

Klimes saw the headline and cringed.

"You want to be successful, of course," he said, "but you don't want to be leading all through the season and then go down early in the playoffs."

"You know, we started the season 6-0 and the nice thing when you look back at those games is that so far there is no player on the team with more than one goal. Everyone contributes and every one helps each other."

**LIVING IN HOLLYWOOD CAN MAKE YOU FAMOUS. DYING IN HOLLYWOOD CAN MAKE YOU A LEGEND.**

**"INTRIGUING! A FILM THAT LINGERS IN YOUR MIND."**

ADRIEN BRODY DIANE LANE BEN AFFLECK BOB HOSKINS

**HOLLYWOODLAND**

BASED ON THE TRUE STORY OF HOLLYWOOD'S MOST NOTORIOUS UNSOLVED MYSTERY. WRITTEN BY PAUL BERGMAN. DIRECTED BY ALLEN COOLTER.

**SEE IT TODAY**

UpTown Entertainment BIRMINGHAM 8 211 S Old Woodward Av 248-644 FLM	AMC FORUM 30 Corner of M 59 & Round Rd 586-754-5663	AMC LYONIA 20 Hopyppy & 7 M 734-542-9909	MJR Theatres SOUTHWATE CINEMA 20 15651 Tanton Rd 734-284-3456
Empire Entertainment CANTON 39535 Ford Rd 888-919-3456	AMC Star GREAT LAKES 25 3725 Strat 800FANDANGO #833	MJR MARKETPLACE CINEMA 20 15 M & Von Dyke 586-264-1514	Phoenia Theatres WEST RYER CENTRE Grand River W of Macleob 248-785-6372
Regal Cinemas COMMERCIAL 14 3033 Spring Vale Dr 248-960-5801	AMC Star GREAT LAKES 25 3725 Strat 800FANDANGO #833	Empire Entertainment NOVY 4425 W 12 Mile Rd 888-919-3456	
AMC Star FAIRLANE 21 18900 Michigan Ave 800FANDANGO #834	AMC Star JOHN R 15 37289 John R Rd 800FANDANGO #839	AMC Star SOUTHWFIELD 20 12 Mile & Telegraph 800FANDANGO #839	

FROM THE PRODUCERS OF UNDERWORLD

**THE COVENANT**

**NOW PLAYING**

PHOENIX THEATRES AT BELLAIR CENTRE 313418 3424	AMC STAR FAIRLANE 21 313470 6389	AMC STAR JOHN R 15 248-585-7970	MJR MARKET PLACE CINEMA 20 582-264-1514	AMC STAR ROCHESTER HILLS 18 745-553-2268	AMC STAR LYONIA 20 734-542-9909
EMAGINE CANTON 734-771-3456	AMC STAR FAIRLANE 21 313470 6389	AMC STAR LAUREL PARK 18 734-467-6700	UP-TOWN CANTON 248-960-5801	AMC STAR WEST RIVER CENTRE 248-388-6972	SHOWCASE CINEMAS WESTLAND 1 & 2 734-779-3630
CANTON CINEMAS 734-798-1900	AMC STAR FAIRLANE 21 313470 6389	AMC STAR LYONIA 20 734-542-9909	UP-TOWN CANTON 248-960-5801	SHOWCASE CINEMAS WESTLAND 1 & 2 734-779-3630	
UP-TOWN CANTON 248-960-5801	AMC STAR FAIRLANE 21 313470 6389	AMC STAR LYONIA 20 734-542-9909	UP-TOWN CANTON 248-960-5801	SHOWCASE CINEMAS WESTLAND 1 & 2 734-779-3630	

**"A GENUINE TREAT FOR ANY AGE"**

-Jeffrey Lyons, NBC's "real talk"

Everyone's **Hero**

STARTS FRIDAY, SEPTEMBER 15

LIVONIA AMC LAUREL PARK	AMC STAR FAIRLANE 21	STERLING HEIGHTS AMC FORUM 30
CLINTON TOWNSHIP AMC STAR GRATIOT 21	AMC STAR GREAT LAKES CROSSING 25	DEARBORN AMC STAR FAIRLANE 21
ROCHESTER AMC STAR ROCHESTER 10	TAYLOR AMC STAR TAYLOR	MADISON HEIGHTS AMC STAR JOHN R 15
CANTON EMAGINE CANTON	NOVI EMAGINE NOVI	CANTON CANTON 7
SOUTHGATE MJR SOUTHGATE 20	DETROIT PHOENIA X BELLAIR CENTER	STERLING HEIGHTS MJR MARKETPLACE CINEMA 20
WESTLAND SHOWCASE WESTLAND	BIRMINGHAM UPTOWN 248-960-5801	FARMINGTON HILLS PHOENIA X WEST RIVER
		WALLED LAKE LA COMM. RECREATION 14

**Zach Braff Jacinda Barrett Casey Affleck Rachel Bilson with Blythe Danner and Tom Wilkinson**

**The Last Kiss**

We all make choices. What's yours?

From the writer of "Million Dollar Baby" and co-writer of "Crash"

DREAMWORKS PICTURES AND LASCAPRE ENTERTAINMENT PRESENT A LASCAPRE ENTERTAINMENT PRODUCTION A DUTY GROUP FILM "THE LAST KISS" ZACH BRAFF JACINDA BARRETT CASEY AFFLECK RACHEL BILSON MICHAEL WESTER FOR CHRISTOPHER NOLAN MARY ELIZABETH MASTROIANI BARBARA LAMORTE BOB OPEL AND TIM PETERSON PRODUCED BY GABRIELE MASTROIANI AND BOB OPEL WRITTEN BY PAUL BERGMAN DIRECTED BY ALLEN COOLTER

**STARTS FRIDAY, SEPTEMBER 15TH**

AMC FORUM 30 211 S Old Woodward Av 248-644 FLM	AMC LYONIA 20 1522 Hopyppy & 7 M 734-542-9909	AMC STAR FAIRLANE 21 313470 6389	AMC STAR GRATIOT 21 2513 W 12 Mile Rd 248-572-2222
AMC STAR GREAT LAKES 25 3725 Strat 800FANDANGO #833	AMC STAR JOHN R 15 37289 John R Rd 800FANDANGO #839	AMC STAR ROCHESTER 10 248-388-6972	AMC STAR SOUTHWFIELD 20 12 Mile & Telegraph 800FANDANGO #839
BIRMINGHAM PALLADIUM 2614 Old Woodward 248-944 FLM	EMAGINE CANTON 734-771-3456	EMAGINE NOVY 4425 W 12 Mile Rd 888-919-3456	MJR MARKETPLACE 20 15 M & Von Dyke 586-264-1514
MJR SOUTHWATE 20 15651 Tanton Rd 734-284-3456	COMMERCIAL 14 3033 Spring Vale Dr 248-960-5801		

ONE GOAL. A SECOND CHANCE.

**GRIDIRON GANG**

BASED ON A TRUE STORY

**STARTS FRIDAY, SEPTEMBER 15**

PHOENIX THEATRES AT BELLAIR CENTRE 313418 3424	AMC STAR FAIRLANE 21 313470 6389	AMC STAR JOHN R 15 248-585-7970	MJR MARKET PLACE CINEMA 20 582-264-1514	AMC STAR ROCHESTER HILLS 18 745-553-2268	AMC STAR LYONIA 20 734-542-9909
EMAGINE CANTON 734-771-3456	AMC STAR FAIRLANE 21 313470 6389	AMC STAR LAUREL PARK 18 734-467-6700	UP-TOWN CANTON 248-960-5801	AMC STAR WEST RIVER CENTRE 248-388-6972	SHOWCASE CINEMAS WESTLAND 1 & 2 734-779-3630
CANTON CINEMAS 734-798-1900	AMC STAR FAIRLANE 21 313470 6389	AMC STAR LYONIA 20 734-542-9909	UP-TOWN CANTON 248-960-5801	SHOWCASE CINEMAS WESTLAND 1 & 2 734-779-3630	
UP-TOWN CANTON 248-960-5801	AMC STAR FAIRLANE 21 313470 6389	AMC STAR LYONIA 20 734-542-9909	UP-TOWN CANTON 248-960-5801	SHOWCASE CINEMAS WESTLAND 1 & 2 734-779-3630	

JOSH HARTNETT SCARLETT JOHANSSON AARON ECKHART HILARY SWANK

**THE BLACK DAHLIA**

INSPIRED BY THE MOST NOTORIOUS UNSOLVED MURDER IN CALIFORNIA HISTORY

**STARTS FRIDAY**

AMC FORUM 30 211 S Old Woodward Av 248-644 FLM	AMC LYONIA 20 1522 Hopyppy & 7 M 734-542-9909	AMC STAR FAIRLANE 21 313470 6389	AMC STAR GRATIOT 21 2513 W 12 Mile Rd 248-572-2222
AMC STAR GREAT LAKES 25 3725 Strat 800FANDANGO #833	AMC STAR JOHN R 15 37289 John R Rd 800FANDANGO #839	AMC STAR ROCHESTER 10 248-388-6972	AMC STAR SOUTHWFIELD 20 12 Mile & Telegraph 800FANDANGO #839
BIRMINGHAM PALLADIUM 2614 Old Woodward 248-944 FLM	EMAGINE CANTON 734-771-3456	EMAGINE NOVY 4425 W 12 Mile Rd 888-919-3456	MJR MARKETPLACE 20 15 M & Von Dyke 586-264-1514
MJR SOUTHWATE 20 15651 Tanton Rd 734-284-3456	COMMERCIAL 14 3033 Spring Vale Dr 248-960-5801		





# NORTHVILLE'S HEAVY HITTERS

By Jeff Theisen  
NORTHVILLE RECORD

The Northville golfers scratched out a one-stroke win, 150-151, during a Sept. 7 scrimmage against Novi at the Tanglewood South course. Mustang sophomore Wes Gates fired a 36 to tie Novi's Scott Czekaj for low score.

Senior Phil Snow was next for Northville with a 37, followed by Richard Allen (38) and Chase Dehne and Alex Bernstein each with 39.

Novi's other scores were Alex Lyall with a 37, Matt Fegert (38) and Nick Prokop (40).

The Mustangs went on to beat Livonia Churchill 149-162, avenging a loss from last season.

Snow, Travis Dehne and Bernstein each tied for medalist with 37. Gates and Allen both carded 38s.

The Mustangs have not lost a match this year.



Mustang Richard Allen putts on the first hole of Tanglewood's South course during a dual meet with the Novi Wildcats.



Mustang Wes Gates tees off on the second hole of Tanglewood's South course.

Photos by JOHN HEIDER  
Northville Record



Mustang Chase Dehne watches his shot off the tee while playing at Tanglewood.



Mustang Trevor Grigs tees off using an iron on the second hole of the South course at Tanglewood.



Northville's Phil Snow watches his shot head towards the green while playing against Novi at Tanglewood Golf course.

# HEALTHY LIVING

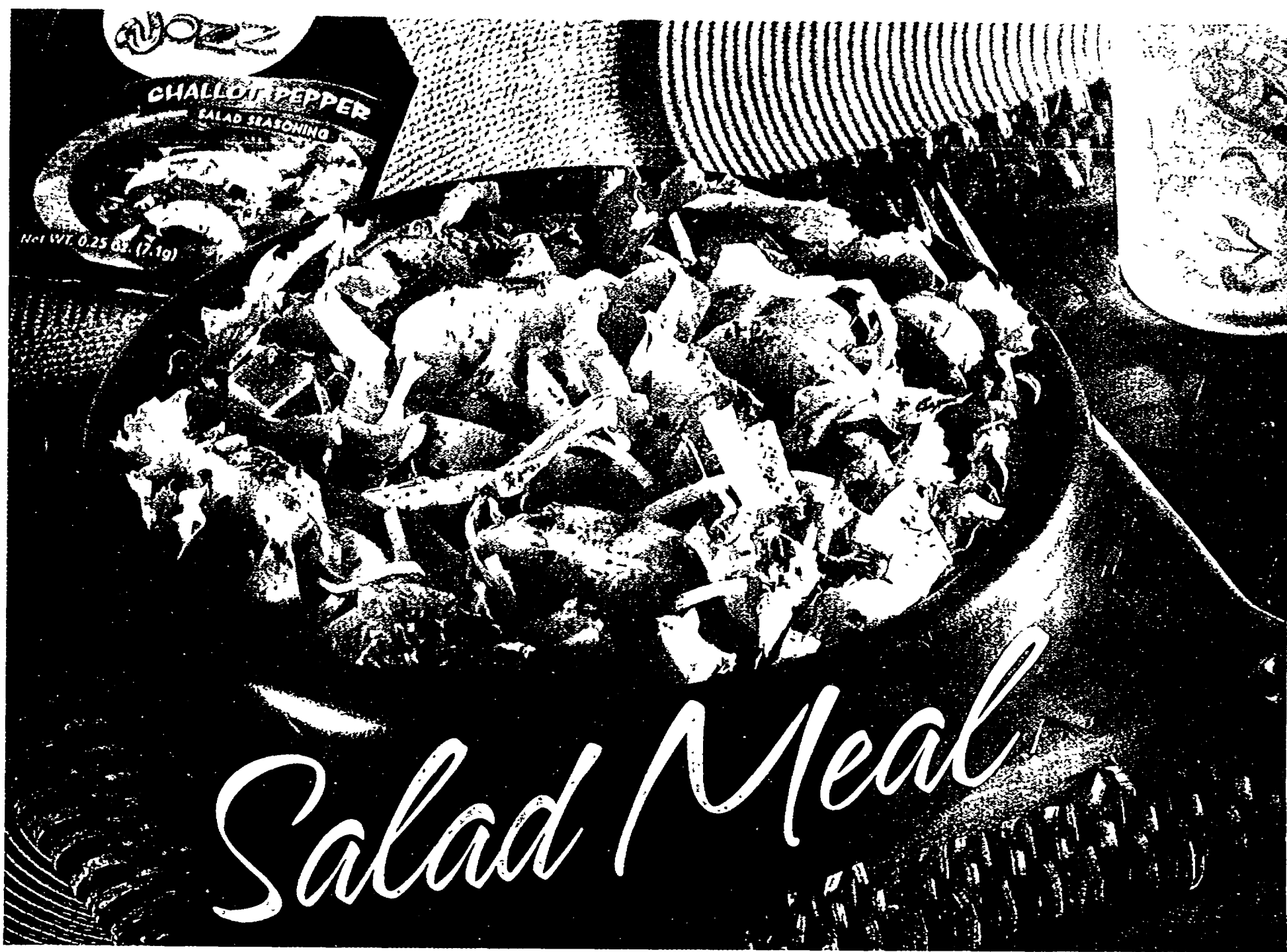

## Salad Meal

Confetti Salad With Crispy Tortilla Strips

### WELLNESS IN A BOWL

FAMILY HEALTH

#### Toss Together<sup>®</sup> Flavor, Taste, Color, Nutrition

Everyone's hungry and they want dinner now. For a super fast meal, reach for that convenient salad blend, toss with flavorful ingredients and enjoy.

Yes, dinner really *can* be that easy. And since ninety percent of us don't get even half of the nine to 13 recommended daily servings of fruits and vegetables we should, making salad the entrée makes good nutritional sense.

Think nine to 13 servings of produce sounds like a lot? One serving equals just one cup of salad greens, one-half cup of cooked vegetables, four tablespoons of raisins or half a large banana. An entrée salad can easily offer eight servings.

Color your salad bowl! Nutritional science reveals that the richer the produce colors you eat — greens, yellows and oranges, blues, reds and purples — the higher the nutrient content and subsequent health benefits. The produce section is a gold mine of vitamins, minerals, fiber, antioxidants and other micronutrients that fight disease and add up to good health.

Health enthusiasts agree. "Eat your colors every day to stay healthy and fit," said Wiley Mullins, founder of America's Wellness Team, an initiative dedicated to helping Americans lead healthier lifestyles.

"Tossing a salad for dinner is the quickest and easiest way to wellness by creating a bowl full of produce servings," Mullins said. A main dish salad is a no-brainer: "Just open the bag, add a few extras, toss and enjoy. Satisfaction guaranteed!"

With more than 40 colorful salad blends to choose from, Dole offers innovative meal solutions so you'll never be bored with salad entrées. From salad kits to salad blends, look for big flavors from different greens and other vegetables for satisfying dinner and meal solutions.

Salad toppings don't have to be high in calories. "Herbs, spices, garlic, peppers and citrus all add some pizzazz to your salad without fat," said Mullins, who developed four blends of Salad Jazz, a line of salad seasonings that add intriguing flavors like Shallot-Pepper, Tomato-Basil, Citrus-Garlic and Chili-Lime. "Add leftover chicken or shrimp and Salad Jazz to a Dole salad blend, and you've got dinner." Salad Jazz can be found right in the produce department with its salad partners.

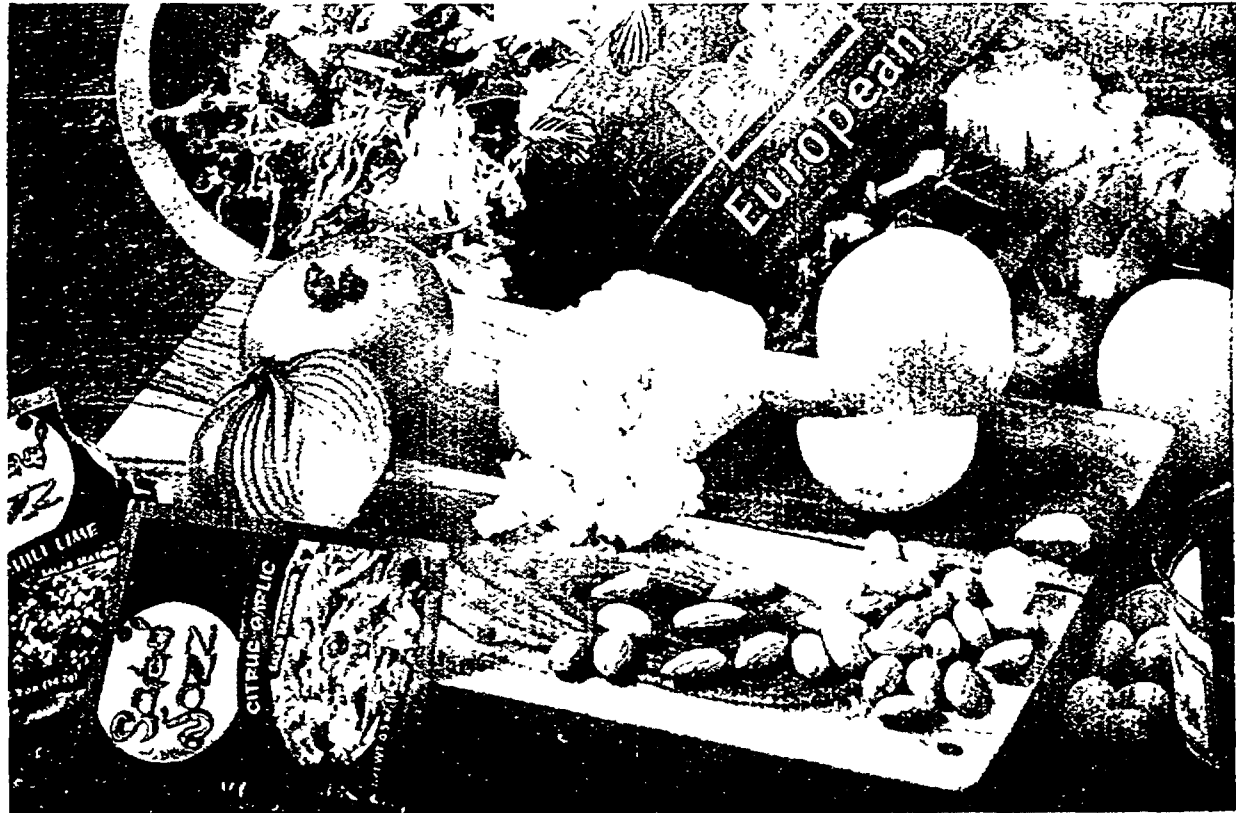

#### Wiley's Wisdom: Super Salad Ideas



- Start with a colorful salad blend. The more colors and varieties of greens in the salad, the better.
- Vary with veggies: Add green beans, cucumbers, tomatoes, onions, radishes.
- Freely add fruit, fresh or dried, like berries, grapes, oranges, apples, pineapple, mangoes or raisins.
- Get nutty: Sprinkle in sunflower seeds, walnuts, almonds or peanuts.
- Add protein: Leftover roasted chicken, black beans or grilled fish are great.
- Drizzle with vinaigrette, sprinkle with Salad Jazz (about one teaspoon per serving), toss and enjoy!

America's Wellness Team offers a free monthly electronic newsletter with nutrition and wellness advice; register at [www.unclewileys.com](http://www.unclewileys.com). The Dole Nutrition Institute, [www.dolenutrition.com](http://www.dolenutrition.com), is a rich resource for nutrition information, recipes, food facts and an informative monthly newsletter. Visit [www.dole.com](http://www.dole.com) and [www.saladjazz.com](http://www.saladjazz.com) for more creative salad recipes.



#### Ensalada Fresca Con Lima

Makes 4 servings

- 1 10-ounce package Dole Mediterranean, American or Italian Salad Blend
- 1 15-ounce can black beans, rinsed and drained
- 1 7-ounce can Mexican corn, drained
- 1 large tomato, chopped
- 1/4 cup vegetable oil
- 1 teaspoon grated lime peel
- 3 tablespoons lime juice
- 2 tablespoons finely chopped fresh cilantro or parsley
- 4 teaspoons Chili-Lime Salad Jazz
- 12 ounces grilled or roasted chicken breast or steak, sliced; or grilled shrimp

Toss salad blend, beans, corn and tomato in large serving bowl, set aside. Combine oil, lime peel, lime juice and cilantro in small bowl; pour over salad, toss to coat evenly. Sprinkle with Salad Jazz, toss and place equal portions on each of four dinner plates. Arrange chicken breast, steak or shrimp atop each and serve immediately.

#### Confetti Salad With Crispy Tortilla Strips

Makes 4 servings

- 2 10-inch flour tortillas, cut into thin strips
- 1/3 cup plus 2 tablespoons fat-free or reduced-calorie Italian dressing, divided
- 1 8- to 10-ounce package Dole American or Very Veggie Salad Blend or other variety
- 1 6-ounce package grilled chicken breast strips
- 2 apples, cored and chopped
- 1 red bell pepper, cut into thin strips
- 4 teaspoons Shallot Pepper Salad Jazz

Toss tortilla slices with 2 tablespoons dressing; scatter strips on baking sheet. Bake at 375 F. for 5 to 8 minutes or until crisp and lightly browned, cool. In large bowl toss together salad blend, chicken, apples, bell pepper, remaining dressing, tortilla strips and Salad Jazz. Serve immediately.

#### Citrus Green Salad

Makes 4 servings

- 1 20-ounce can Dole pineapple chunks
- 1 10-ounce package Dole European Salad Blend or other variety
- 1 orange, peeled, halved and sliced
- 1/2 cup halved and sliced red onion
- 1 cup chopped nuts, toasted
- 1/2 cup crumbled feta cheese
- 1 tablespoon grated orange peel
- 2 tablespoons vegetable oil
- 2 tablespoons balsamic or red wine vinegar
- 4 teaspoons Citrus-Garlic Salad Jazz

Drain pineapple chunks, reserve 1/4 cup juice. In large serving bowl combine pineapple, salad blend, orange, onion, nuts and cheese, set aside. In small bowl, whisk together reserved pineapple juice, orange peel, oil and vinegar, drizzle over salad, sprinkle with Salad Jazz, toss and serve.

## BUSINESS SENSE

### ABCs of Nurture Marketing: Always Being Connected

By Karin Schaff Glazier  
NATIONAL FEDERATION  
OF INDEPENDENT BUSINESS

The concept of nurture marketing has been around for a long time. However, with narrowing customer markets, fierce competition and an abundance of consumer purchasing options, nurture marketing is changing from a want to a critical need for survival. Much of nurture marketing involves basic common sense: Treat others the way you would like to be treated to keep in touch with prospects (new and existing customers) and develop and cultivate relationships to generate new business. Here are just a few highly valuable but simple tips you can use to begin developing your nurture marketing game plan:

**Know your ABCs (and Ds)!** Before jumping headfirst into nurture marketing activities, dissect your prospect base into A, B, C and D accounts. Typically, the A and B accounts are where most of your revenue will come from in the near term, per your sales plan and ideal client profile. The C and D accounts are those that hold potential to become revenue-generating accounts, though not necessarily in the near term. The As and Bs typically receive personalized communication when possible. The Cs and Ds tend to receive more of what the industry calls "drip" marketing, which means activities are more general rather than highly personalized by account and contact type.

**Become the trusted advisor.** Nurture marketing helps to establish you as a trusted advisor in the minds of your prospects—and therefore puts you at the top of their list when they are searching for or trying to make a decision regarding your type of offering. Ask yourself what you need to provide so that they will see you as a trusted advisor. Remember, your product/service information is important, but it isn't everything. Industry reports, case studies (industry case studies as well as your own), articles, Webinar invites, etc., can also be powerful tools. These tools eventually build your nurture marketing tool kit.

**Execution is key.** Once you have developed your nurture marketing tool kit (which should grow continuously to keep information fresh and new), start to assign activities/materials to specific prospect types (the A, B, C, and D accounts). Record specific dates in your calendar when materials should be sent out to each prospect. You may not know what materials you will send two months from now, for example, but you should at least note that you will be sending something on X date. And, don't forget about the in-person visits and outings: they are great tools to add to your nurture activities. You may also have multiple contacts per target account which value different information sent in different ways—and possibly at different times. The information sent to the A and B accounts should be personalized. Sales should lead this effort (i.e. sending an article, highlighting the important concepts, adding a handwritten note, mailing in hard copy format). Be sure to explain why you are sending the information, otherwise prospects may not understand how the information pertains to their business objectives and functional needs. The C and D accounts may receive the same information but in more of a canned/ongoing campaign type approach through mediums such as monthly e-zines or direct mailers. These activities tend to offer the same information to the same people at the same time, and the marketing department tends to oversee these efforts.

**Track your activities.** It's important to know what you are sending, when and why. Using technology (i.e. customer relationship management and/or sales force automation) to track all your nurture activities helps give you and others visibility into what is working, when and with whom. This allows you to continually improve your approach for better results.

The tips above are only a handful of the things you can do to proactively connect with your prospects. Nurture marketing is a forever commitment that needs some basic ingredients, such as common sense, strategic planning, consistent follow through and passion for getting close to your prospects, so you can reap the many rewards it offers.

ADVERTISEMENT

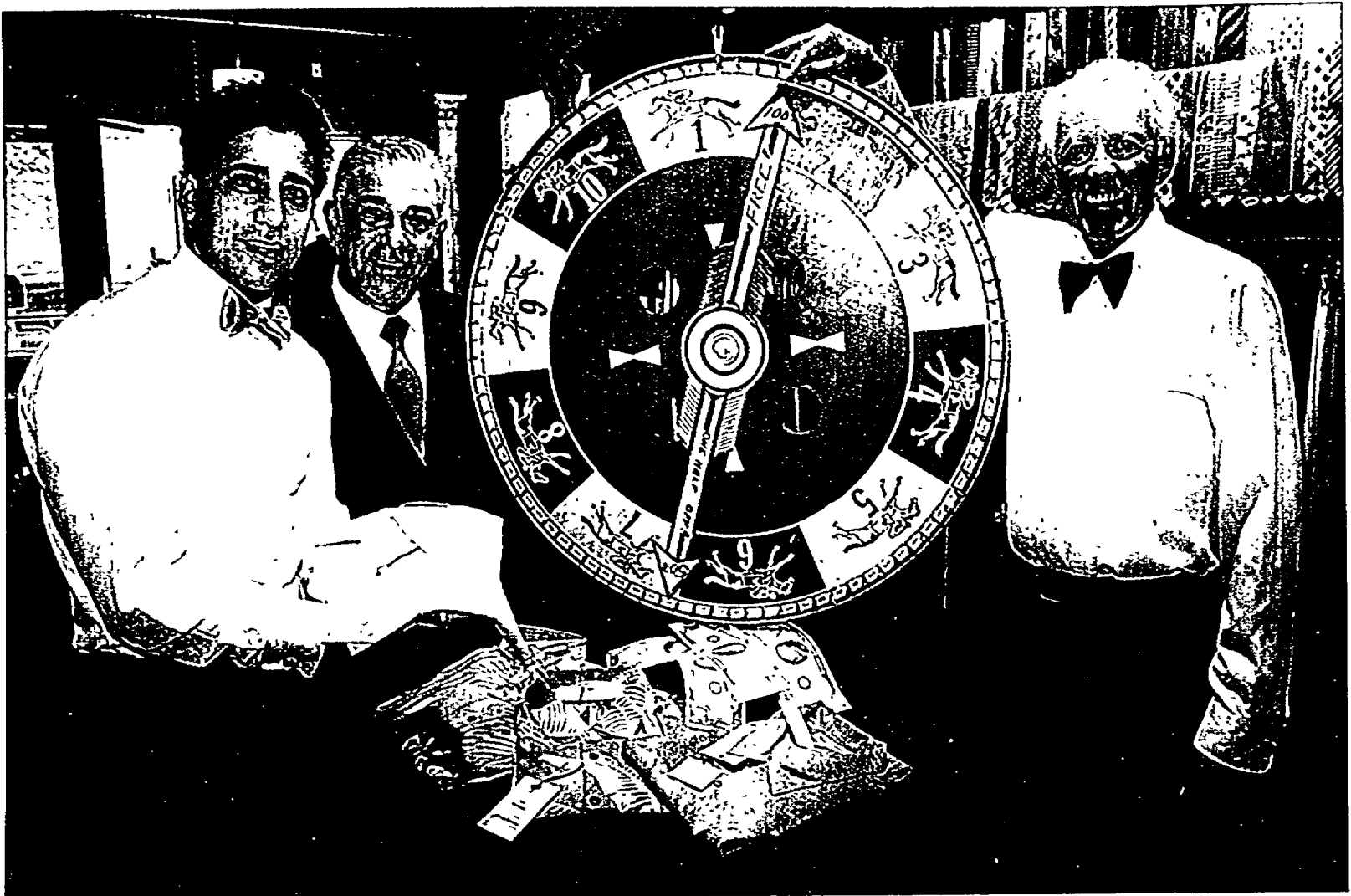

Photos by JOHN HEIDER, Gannett News Service

Alexander Hamka, left, and his father Sam, center, are borrowing an idea from former Northville clothier Chuck Lapham, right. Beginning tomorrow, Alexander's customers will spin the wheel to determine discounts during an upcoming sale.

## Alexander's: A perfect fit

Custom clothier mixes style with personalized customer service

By Kate Phillips  
SPECIAL WRITER

### ALEXANDER'S

Location: 124 W. Main St. in downtown Northville  
Phone: (248) 349-6080

This week, Northville will be abuzz with a Wheel of Fortune Sale at Alexander's Custom Clothiers. The 10-day sale, running Sept. 15-25 will give customers a chance to win 5 to 100 percent off men's clothing.

Alexander's is bringing back Northville's favorite men's clothier, Chuck Lapham, for a sale tradition from the popular Lapham's of Northville. Customers crowded in for the Wheel of Fortune sale at Lapham's, which finally closed after 40 years of business when Lapham retired in 1995.

"Everyone is a winner," explained Alexander Hamka, owner of Alexander's. "You could get half off or you could get an entire wardrobe for free."

Men can win large discounts on fine Italian garments like jackets, slacks, dress shirts, sports wear, sleep wear, shoes and accessories in brands like Jhane Barnes, Palzaleri and Zanetti. Only made to measure and custom-made suits and dress shirts are not included in the sale.

Once they've selected clothing, customers can give the Wheel of Fortune a spin to determine their discount. Every customer gets a discount of at least 5 percent — most get 30, 40 or 50 percent off, or more. And those with a touch of luck can spin themselves a free wardrobe — whatever they have selected in advance.

Alexander's has pulled out all the stops to offer tailoring services as a part of the Wheel of Fortune Sale. Customers can bring in men's or women's fashions or bridal wear, then spin the wheel to win a big discount.

Alexander Hamka has developed a solid reputation as both a tailor and an image consultant. He's cultivated a stand-out image for players on the Detroit

Lions. He's helped celebrities like "Superman" Dean Cain maintain a superstar look.

Alexander offers wardrobe and image consulting at his store or at client's home. He drives to a client's home or office with hundreds of swatches and photographs to create just the right clothing. Alexander steps into a crowded closet and helps weed out outdated clothing, replacing it with new clothing that coordinates with the remaining pieces.

"The right clothing changes your way of thinking," said Alexander. "When you come to work dressed in a fine suit, you feel motivated to work hard and achieve. It changes the way others think about you, too."

Alex helps create custom suits that complement the body shape of each client. Practically every piece of the suit is hand-stitched to create a one-of-a-kind masterpiece. Custom dress shirts made of fine materials add just the right touch and are extremely comfortable for all-day wear.

The men's clothier also offers high quality made to measure suits ranging from \$495 to \$1,500. The store has many styles and colors in stock to fit every size and build.

"When it's right for you, you just know it, there's no wondering," Alex said. "My clothes make you feel good about yourself."

The Wheel of Fortune Sale will run 10 days only, starting tomorrow. Sale hours run Monday through Friday 10 a.m.-7 p.m., Saturday 10 a.m.-5 p.m. and Sunday noon-4 p.m.

Alexander's Custom Clothiers is located at 124 W. Main St. in downtown Northville. Stop by the store or contact Alex at (248) 349-6080.



Alexander's Custom Clothier on Main Street in downtown Northville offers clients full service, including fitting and custom tailoring.

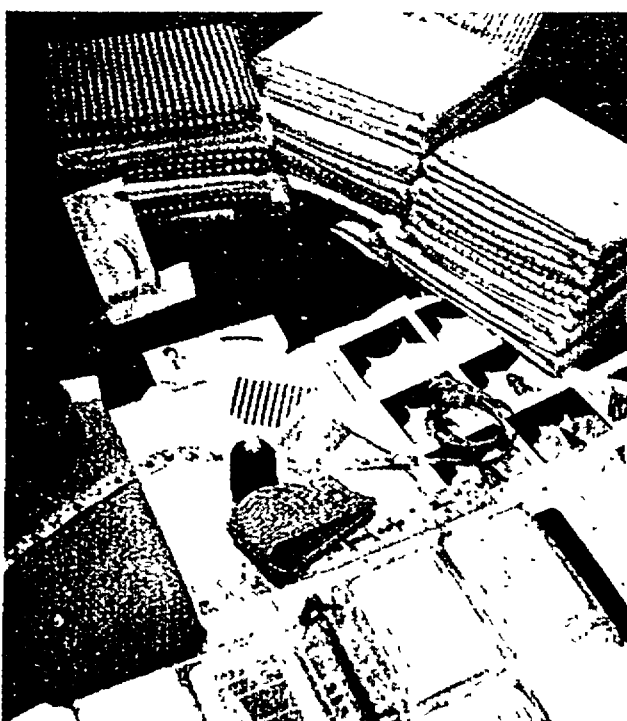

# A

ALEXANDER'S  
CUSTOM CLOTHIERS  
- Northville

Buy 6 Custom Shirts  
Get 7th Shirt FREE

124 West Main Street  
Downtown Northville • 248-349-6080













<b>Garage Sales</b> (7119) WHITE LAKE, 2 FAMILY. Lots of teen girls clothes furniture & books Sept 15, 16, 9am to 5pm 8847 Sussex, Village Acres Sub. off of Union Lk. Rd	<b>Appliances</b> (7180) AMANA washer/dryer, stainless steel tub. Flatless \$340. Both 248-830-0972	<b>Farm Equipment</b> (7380) FORD TRACTOR 9N w/rear blade & rear scoop \$2250. best 810-227-6448 after 3pm	<b>Tree Sales</b> (7495) PINES, SPRUCES. Large selection, 5 to 35ft tall. Delivery & installation avail. Low prices. 248-231-0306 or 248-349-5480	<b>Sporting Goods</b> (7520) AIR HOCKEY Table 7.5, brand new, still in box. \$200. 248-767-8998	<b>7800-7980 ANIMALS/PETS/LIVESTOCK</b>	<b>Dogs</b> (7140) PUPPIES Small mixed breeds 10-15 lbs. max as adults. Some non-shedding, all current on shots & worming. \$250-\$300. 517-404-3045 517-404-1028	<b>Lost - Pets</b> (7930) LOST Black cat, Commerce Rd & Hazy View Ln/Duck Lk. Rd. Milford Reward 248-496-9844	<b>Off Road Vehicles</b> (8990) WE BUY USED ATVs & STREET BIKES. Call Dan L. for details 810-227-7068 ext 20
<b>Moving Sales</b> (7130) BRIGHTON- Fr., Sat., Sun. 9am-5pm 1060 Steph Lane Furniture accent pieces, TV's, stereo system 810-227-7026	<b>Dishwasher &amp; Fridge</b> (7180) DISHWASHER & FRIDGE: stainless steel, side by side & Advantus Oven A1 new. Call (810) 229-5976	<b>Farm Produce</b> (7400) RASPBERRIES We pick fresh every day \$3.00 per pint. Located just N of M-59, on Oak Grove Rd. Howell 517-546-5622	<b>Trees Going Out of Business Sale</b> (7495) ALL TREES MUST GO! Shade Trees & Ornamentals, 20% Below Wholesale. Evergreens also available. Watson Farms, Fowlerville 517-223-3235/517-410-3589 after 4pm weekdays & after 10am weekends	<b>Cats</b> (7130) HUGE WALK-IN PARROT AVIARY 8 ft. octagon, 7 ft. tall, clean, in excellent condition! \$950 810-231-5959	<b>Birds &amp; Fish</b> (7120) KITTEN & CATS Beautiful markings, black & white female and 4 males to good home. Only cages optional. (248) 437-3038	<b>Rotweiler Puppies</b> (7140) 2 Males, \$400 each. Call 810-632-7365 or 517-552-1902	<b>Recreational Vehicles</b> (1100) FORD '77 Class 'C' Motor Home. Hunters Special \$750 (734) 498-2730	
<b>Household Goods</b> (7160) A TABLE & 6 CHAIRS Maple top w/white wash chairs & legs \$475 517-546-3303	<b>Pools, Spas, Hot Tubs</b> (7190) AURORA 2 Great cond seats 5x, 27 jets 5 yrs old w/cover \$1500. best 248-887-4902	<b>U-Picks</b> (7410) ACRES OF RASPBERRIES \$3.00/pt U-pick. Also farm fresh honey 8779 Diabolo Rd., South Lyon for farm info call 248-437-1631	<b>Miscellaneous For Sale</b> (7500) A Cherry Sleigh Bed & pillow-top mattress, new in box. Retail \$1K, only \$395 734-891-8481	<b>Dogs</b> (7140) RESCUE CATS FOR ADOPTION Medical complete. Barn cats also. (248) 821-1252	<b>Farm Animals/Livestock</b> (7150) FANCY FEEDER PIGS 7 wks old. Delivery available. Dewormed & shots, also Roasting Pigs 517-546-3809	<b>Boats/Motors</b> (8020) SEA DOO SP '95 exc cond TIGERSHARK '95 needs carb work. incl trailer \$2400. best Must sell! 734-354-1899	<b>Snowmobiles</b> (8110) Snowmobile Trailers 1996 11Tron Covered \$1000, 1 Open \$625 2000 Sportman 4x4 \$500 \$4200 989-206-9246 Howell	
<b>Bed King Pillowtop mattress set. New, in bag, only \$195. Deliverable (734) 891-8481</b>	<b>WATER HEATER</b> Vent free, pedestal, good cond. \$50. best (517) 223-3871	<b>Hay, Grain, Seed</b> (7415) FIRST CUTTING ALFALFA, TIMOTHY HAY & STRAW 2nd & 3rd CUTTING ALFALFA Call Rocky Ridge Farm 517-404-3335	<b>CASINO SLOT MACHINES</b> \$650 each, best 734-498-3636	<b>Dogs</b> (7140) ABSOLUTELY ADORABLE PUPPIES - BIG SALE Only at PETLAND Waterford. Prices Reduced 10% to 40%. Save another \$50 with this ad 248-666-6011	<b>Himalayan Rabbits</b> (7150) Show quality \$10 each. Mixture of chickens \$5-\$10 each. Call 517-468-3395	<b>Boats/Motors</b> (8020) BRAND NEW 17 ft. Bowrider Free winter storage \$12,285. Call Kevin at 248-891-9552	<b>Construction, Heavy Equipment</b> (8140) EQUIPMENT SALE Two 1 Axc Dumps, a 2120 Ford & JD Tractors, Stud Loader, Trailers, Sater, Tools 248-665-9720	
<b>WOOD STOYE</b> \$75. best. Brush Guard fits Blazer \$50. Call 517-404-2412	<b>WATER HEATER</b> Vent free, pedestal, good cond. \$50. best (517) 223-3871	<b>Firewood-Merchandise</b> (7440) BLENDED HARDWOOD - \$69 (48x16) delivered. Delivery kurling stacking incl 2 face cord minimum. 248-446-8281	<b>Generator, Craftsman, 7.0 hp, 3500w cont w/wh/blade kit, 120v/220v, best offer \$450. Tel 517-404-4781</b>	<b>HORSE SHOEING</b> (7160) A & S SUPPLY- Compare & Save! Treated fence posts. Oak fence boards. Wood, w/rod, vinyl horse fencing. Post holes dug. Pole barns, barn stabs & run in shelters. Material and/or installation avail. LeClus Free Estimates (810) 231-1788	<b>Himalayan Rabbits</b> (7150) Show quality \$10 each. Mixture of chickens \$5-\$10 each. Call 517-468-3395	<b>Boats/Motors</b> (8020) PONTON 24ft., 1988, \$1,500. Call 734-878-6474	<b>Construction, Heavy Equipment</b> (8140) EQUIPMENT SALE Two 1 Axc Dumps, a 2120 Ford & JD Tractors, Stud Loader, Trailers, Sater, Tools 248-665-9720	
<b>WATER HEATER</b> Vent free, pedestal, good cond. \$50. best (517) 223-3871	<b>WOOD STOYE</b> \$75. best. Brush Guard fits Blazer \$50. Call 517-404-2412	<b>Firewood-Merchandise</b> (7440) BLENDED HARDWOOD - \$69 (48x16) delivered. Delivery kurling stacking incl 2 face cord minimum. 248-446-8281	<b>Generator, Craftsman, 7.0 hp, 3500w cont w/wh/blade kit, 120v/220v, best offer \$450. Tel 517-404-4781</b>	<b>HORSE SHOEING</b> (7160) A & S SUPPLY- Compare & Save! Treated fence posts. Oak fence boards. Wood, w/rod, vinyl horse fencing. Post holes dug. Pole barns, barn stabs & run in shelters. Material and/or installation avail. LeClus Free Estimates (810) 231-1788	<b>Himalayan Rabbits</b> (7150) Show quality \$10 each. Mixture of chickens \$5-\$10 each. Call 517-468-3395	<b>Boats/Motors</b> (8020) PONTON 24ft., 1988, \$1,500. Call 734-878-6474	<b>Construction, Heavy Equipment</b> (8140) EQUIPMENT SALE Two 1 Axc Dumps, a 2120 Ford & JD Tractors, Stud Loader, Trailers, Sater, Tools 248-665-9720	



**OPEN SATURDAY 10-3**

**LEASE PULL-AHEAD ALL LEASES EXPIRING NOW THRU 7/07/07 See dealer for details**

**THE BEST COVERAGE IN AMERICA! See dealer for details**

<p><b>2006 ENVOY XL SLT 4DR</b></p> <p><b>GMS LEASE \$199<sup>00</sup>*/mo.</b></p> <p>\$3,264 due at signing</p> <p>Polished alum. wheels, power sunroof, XM satellite radio, heated front seats, rain sensing wipers, Bose prem. sound system. Stk # 60280 DEMO</p>	<p><b>2007 YUKON 4WD</b></p> <p><b>GMS LEASE \$298<sup>00</sup>*/mo.</b></p> <p>\$9,293 due at signing + tax, title, doc</p> <p>AP3 remote vehicle starter, CFS power sliding sunroof, UOA Bose premium speaker system, AM/FM stereo w/MP3. Stk # 70108 DEMO</p>
<p><b>2007 SIERRA 1500 4WD 4x4 REG CAB W/T</b></p> <p><b>GMS LEASE \$259<sup>00</sup>*/mo.</b></p> <p>\$2,804 due at signing</p> <p>WAS \$24,288<sup>00</sup> NOW \$19,845<sup>00</sup></p> <p>Dual zone air cond., auto lock differential, handling/trailing suspension pkg., power windows and mirrors. 10k miles. Stk # 70132</p>	<p><b>2006 SAVANA WORK VAN</b></p> <p><b>WAS \$22,402<sup>40</sup> NOW \$20,652<sup>40</sup></b></p> <p>Remote keyless entry, HD read locking differential, power windows, auxiliary lighting, AM/FM stereo w/CD. Stk # 66204</p>
<p><b>2006 SIERRA 1500 4WD SLT CREW CAB</b></p> <p><b>WAS \$35,954<sup>00</sup> NOW \$27,591<sup>68</sup></b></p> <p>Vortec 5.3L HD trailing equip. *T* po. disc. cast alum. wheels. Z71 SLT decor. Bose speaker sys. remote keyless entry sys. bedliner. Stk # 66333 DEMO</p>	<p><b>2006 SIERRA 1500 4WD EXT CAB SLT</b></p> <p><b>WAS \$35,655<sup>00</sup> NOW \$26,144<sup>73</sup></b></p> <p>Vortec 5.3L 295HP, OnStar plus package, Z71 off-road suspension package, SLT decor. Bose premium speaker system, remote keyless entry system. Bedliner. Stk #60550 DEMO</p>

**WE ARE PROFESSIONAL GRADE.**

Hours: Monday & Thursday 9am-9pm, Tues., Wed., & Fri. 9am-6pm, Saturday 10am-3pm

**www.superiorcadillacgmc.com**

**SUPERIOR BRIGHTON**

8282 W. Grand River, Brighton (I-96 Exit 145)

**810-227-1100**

<p><b>2007 CTS V6 VVT</b></p> <p>GMS LEASE \$219<sup>00</sup>*/mo. SIGNING \$2814</p> <p>27 mos./10k yr. DUE AT</p>	<p><b>2007 ESCALADE AWD</b></p> <p>GMS LEASE \$675<sup>00</sup>*/mo. SIGNING \$4920.00</p> <p>39 mos./10k yr. DUE AT</p>	<p><b>2006 CADILLAC DTS LUXURY II</b></p> <p>GMS LEASE \$342<sup>25</sup>*/mo. SIGNING \$2887.00</p> <p>39 mos./10k yr. DUE AT</p>	<p><b>2006 CADILLAC XLR</b></p> <p>GMS LEASE \$689<sup>00</sup>*/mo. SIGNING \$3933.00</p> <p>39 mos./10k yr. DUE AT</p>
---	--	--	--

**Monday & Thursday 9am-9pm, Tues., Wed., & Fri. 9am-6pm, Saturday 10am-3pm**

**8282 W. Grand River, Brighton (I-96 Exit 145)**

**810-227-1100**

Trucks for Sale (220) Sports & Imported (300) Ford (448) Pontiac (468) Auto Misc. (150) Auto Misc. (150) Auto Misc. (150) Auto Misc. (150) Auto Misc. (150) Auto Misc. (150)

**Trucks for Sale**  
**CHEVY S-10 1998** Ext. Cab, auto, air, great shape \$3995 At Howell Tire, 517-546-4160  
**FORD RANGER 1991**, 4 Ltr, automatic, just rebuilt w/air New power steering pump, stereo, rear side window, tool box, new tires & wheels \$2900 best 517-404-4781

**CORVETTE 92**, 350 a.to, 1 owner in Fla since new Blue/gray leather New tires, Grandpa's car, runs exc. 105K \$9700 best 249-882-0184  
**Antique/Classic Collector Cars (320)**

**FORD EXPLORER 2002** 4 Dr, air, pl, cruise, CD, anti-lock brakes, pw, Full service history, 1 owner, ps, am fm stereo Non smoking family car, Air bags, luggage rack, trailer tow package \$9,499 Tel. 810-225-0813  
**FORD FESTIVA 1992** 2 Dr, am-fm stereo Transportation special, 40mph, best offer \$750 Tel 517-404-4781

**PONTIAC TRANS AM CONVERTIBLE 1992** 2 Dr, air, alarm, pl, cruise, CD, anti-lock brakes, pw, Full service history 1 owner, ps, am fm stereo, leather 5 speed manual Red with tan interior. 15,560 original miles immaculate condition Appraisal is available on request. \$15,500 00 Tel 810-216-2000  
**VIBE 2003** 1 8L, PWPL, CD, 1 owner, clean 67,000 miles, 33mpg \$6900 810-227-4358

**Mini-Vans (244)**  
**CHEVY 1997 VENTURE LS** Est. 172,000 miles Runs good. \$2,275 810-449-9302  
**CHRYSLER TOWN & COUNTRY, TOURING-2005** \$18,000. Call (517) 304-3146

**CHEVY CORVETTE, 1960** Restored all original blue \$55,000 734-604-0874  
**CORVAIR 1964** Monza coupe 110 engine, runs well, needs part & body work to restore \$1000 best 989-288-2143

**Mustang '07** Black premium coupe V6, a.to, Pony pkg cd, 17" wheels 1500 miles Senior \$19,750 517-545-5589  
**2001 EXT. CONVERTIBLE** Mustang Exc condition, \$8399 Tyme Auto Sales 734-455-5566

**Toyota (470)**  
**TOYOTA PRIUS 2004** Silver, 50-60 MPG Average, 37,000 miles. Loaded w/navigation system, Factory Powertrain Warranty. Adult owned non-smoker \$19,500 00 Tel 734-878-4607  
**Autos Over \$2000 (1760)**

**CHRYSLER TOWN & COUNTRY, TOURING-2005** \$18,000. Call (517) 304-3146  
**CHRYSLER TOWN & COUNTRY** Touring, 2005 4 door, 2000 miles. 4.0 engine, 38 mpg. \$7,200 Call 517-230-3953  
**Cadillac (1380)**

**CENTURY** 2003 4 dr, white, 38,000 miles Auto start, pw, plps \$7,200 Call 517-230-3953  
**ALLANTE, 1988** Convertible w/hardtop Red w/tan leather great shape, all options \$8,000 best (810) 229-2854  
**SEDAN DEVILLE 1996** 94,000 miles, clean car \$5000 best 810-227-3168

**Honda (8520)**  
**CIVIC DX 1994** 4 door, 95,000 miles new tires & exhaust system, runs great! \$4,000 248-596-0364  
**Jeep (8535)**

**WRANGLER, 1994-4X4** Green, manual trans, \$1995 best (810) 231-5403  
**Autos Under \$2000 (1760)**  
**\$5005 POLICE IMPOUNDS** Fee Cars from \$500! for listings 1-800-495-0660 Ext V367

**FORD 1998 WINDSTAR** Runs Good. \$2,400 best. Call 810-229-5976  
**HANDICAP VANS BOUGHT & SOLD.** Call Dale any day, I come to you. 517-230-8865  
**HONDA ODYSSEY, 2003.** EX. 51,000 miles, exc cond \$16,500 (517) 546-3460

**PT CRUISER 2001** Auto, air immaculate \$5999 TYME (734) 455-5566  
**Chrysler-Plymouth (8420)**

**GRAND CHEROKEE LAREDO** 2002, Special Edition, 4WD, 4.0 L V-6, Leather int., Pwr roof, new tires/brakes 67,000 Miles \$12,300 734-667-1935  
**Mercury (6600)**

**GRAND MARQUIS, 05'** CD Power, 20K warranty \$11,900 (734) 484-0849  
**MERCURY SABLE 2002** LS Premium, Leather, 6-Disc CD Changer 85,000 Highway miles Located in Brighton \$5,900 Tel 313-549-2140  
**Pontiac (8680)**

**FORD 97, High top, Conv Loaded, TV/VCR, 192 K, very clean, \$2,800 313-402-0810**  
**4 wheel Drive (8280)**

**STAR**  
**CHRYSLER 2003 PT Cruiser.** DO YOU HAVE A KID GOING TO COLLEGE? Looking for a great car? Sport turbo Loaded 32,000 miles midnight blue, sporty, sharp, exc cond \$12,500 best. 810-231-0522 810-533-2582  
**LABARON 1992, Conv, V6 AM-FM CD, exc running cond Clean \$2300 248 887-8702**  
**Dodge (8440)**

**GRAND AM SE, 2000** 2 dr looks and runs great \$4250 best (517) 223 5881  
**GRAND AM GT 1998** Good shape. \$3000 best See at Howell Tire, 517-546-4160  
**GRAND PRIX SE 1996** 4 Dr Highway miles, grandma's car \$3,700 (517) 223 5881  
**GRAND PRIX GTP 2005** 6,000 miles, leather, 6-disc CD, sunroof tap shift, HUD, XM Radio, remote start, Warranty Not Started \$21,926 Call Tom Lynn, 810-225-7166

**GMC Satin Van, 8, Pasl, 1990, good cond \$1250 (810) 227-5720**  
**RANGER, 1994 Ssp, 158K, 1 owner, needs rear end work, new air \$1995 (517) 548-9159**  
**VOLKSWAGEN BUG, 1968** Needs work. \$500 best (517) 546-8415

**FORD, 1979 F-350** Ranger XLT, 429 CU, C-6, Nice Arizona Truck. \$6000 (734) 891-9949  
**GMC 1992 Short bed, \$3 600** Black, 35" mud tires too much to list. 517-376-2833  
**Sports Utility (8290)**

**NEON 2000** 28,000 miles Immaculate \$99 down, \$118/mo NO co-signer needed Tyme Auto Sales 734-455-5566  
**NEON 2000** 28,000 miles Immaculate \$99 down, \$118/mo NO co-signer needed Tyme Auto Sales 734-455-5566  
**Ford (8480)**

**ESCORT, 1999 SE 4 door.** 80,000 miles Aqua Marine, clean \$4,200 (810) 227-6336

**Recycle this Newspaper**

**CHEVY BLAZER, 2004** 2WD, 11,200 miles, 4 door, \$9,900 (734) 878-9244  
**ESCAPE XLT 2005, 4X4, trailer,** leather, loaded, well care for \$16,200 best (734) 954-0322  
**EXPLORER XLT 2005, 4x4** 12,000 mi, loaded, exc cond Must sell! 517-548 5061  
**FORD EXPEDITION- 1998** Eddie Bauer, exc cond Forest Green, Trailer hitch, \$8995 734-476-0611, 517-552-2991  
**LAND ROVER DISCOVERY II** 1999 Loaded, all leather, heated seats, dual sunroofs premium sound, snow & tow pkg, all off road options & only 106,000 miles \$8,700 best 734-649-5417

**ESCORT, 1999 SE 4 door.** 80,000 miles Aqua Marine, clean \$4,200 (810) 227-6336

**Auto Misc. (1150)**  
**Auto Misc. (1150)**  
**Auto Misc. (1150)**  
**Auto Misc. (1150)**  
**Auto Misc. (1150)**  
**Auto Misc. (1150)**  
**Auto Misc. (1150)**  
**Auto Misc. (1150)**

# SWITCH TO LARICHE

**IN PLYMOUTH**  
**Summer Blowout**  
**On All 2006's**  
**Just Announced...**  
**5 YEAR/100,000 MILE WARRANTY!**

# \$218\*

per mo.  
**2007 Impala LT1**  
 • Flip & fold rear seat  
 • Power windows and locks • Tint glass  
 • Air • Cruise & Tilt • Stereo CD  
 • 3.5 flex fuel and more!

27 Mo. - 22,500 Mile Lease

GMS	EVERYBODY
Down.....\$995	Down.....\$2145
1st Pay.....\$218	1st Pay.....\$218
Total Due.....\$1213	Total Due.....\$2363

**OPEN MONDAY & THURSDAY NIGHTS UNTIL 9 PM**  
**40875 PLYMOUTH RD. AT HAGGERTY • ACROSS FROM UNDS.**  
**1.866.385.8000**  
**Lou LaRiche**  
**CHEVROLET**  
**MON. & THURS. 8:30AM-9PM • TUES., WED., & FRI. 8:30AM-6PM**

Auto Misc. (1150) Auto Misc. (1150) Auto Misc. (1150) Auto Misc. (1150) Auto Misc. (1150) Auto Misc. (1150) Auto Misc. (1150) Auto Misc. (1150) Auto Misc. (1150) Auto Misc. (1150)

**DISCOVER THE DEMMER DIFFERENCE**

# JACK DEMMER FORD

## 0% UP TO 60 MONTHS ON SELECT 2006 MODELS

**2007 FOCUS ZX5 SES** 23 City 34 Hwy  
 Power side windows, convenience group, integrated fog lamps air, 16" alloy wheels, power locks, auto trans, safety pkg ABS side impact air bags, weather pkg heated seats Stock #70428  
**Was \$18,795 NOW \$13,141**  
 24 MONTH LEASE RENEWAL  
 SIGN & DRIVE \$182/mo ZERO DOWN \$169/mo \$1000 DOWN \$127/mo

**2007 FUSION SE FWD** Great looks Roomy & Saves You on Gas 23 City/31 Hwy  
 2.3 L4 engine, 5-speed automatic transmission, P205 60R16 all season tires, front license plate bracket Stock #70345  
**Was \$19,705 NOW \$16,253**  
 24 MONTH LEASE RENEWAL  
 SIGN & DRIVE \$248/mo ZERO DOWN \$234/mo \$1000 DOWN \$191/mo

**2007 600 SEL FWD** 2007 Model 5 Star Rated  
 Power exterior mirrors and lock brakes, air conditioning, power seat, power door lock, 3.0L I4 V6 Duratec engine P215 65R17 84A tires \$0.50/3rd tire sale \$17.50, 40 mph 3 pass 2nd row Stock #71125  
**Was \$24,415 NOW \$18,439**  
 24 MONTH LEASE RENEWAL  
 SIGN & DRIVE \$282/mo ZERO DOWN \$241/mo \$1000 DOWN \$198/mo

**2006 F150 SC 4X4 XLT** TOW & GO F150 LEASE RENEWAL  
 Pref equip pkg 507A XLT series 5.4L EFI V8 e ec 4 spd auto O D P255/70R17 OWL a 55 tire 5.55 mi/h slip axle 7200A CVR pkg sliding rear window Stock # 2394  
**Was \$34,380 NOW \$21,140**  
 24 MONTH LEASE RENEWAL  
 SIGN & DRIVE \$282/mo ZERO DOWN \$241/mo \$1000 DOWN \$198/mo

**2007 ESCAPE XLT FWD** 23 City 26 Hwy  
 16" alum wheels, floor mats front & rear perimeter alarm, priv glass, 4 spd auto O D trans, pwr moonroof, rear cargo conv grp, audioblu CD in dash/vat cap Stock #70259  
**Was \$24,250 NOW \$18,678**  
 36 MONTH LEASE RENEWAL  
 SIGN & DRIVE \$240/mo ZERO DOWN \$229/mo \$1000 DOWN \$201/mo

**2007 SPORT TRAC XLT** Energetic Strong Versatile The All New 2007 Sport Trac  
 16" cast alum wheels, AM-FM angle CD MP3 4 DL, SOHC 2V V6 5-speed auto trans, power moonroof, auto headlights, entry keypad, hard tonneau cover Stock #70619  
**Was \$26,710 NOW \$21,395**  
 24 MONTH LEASE RENEWAL  
 SIGN & DRIVE \$242/mo ZERO DOWN \$224/mo \$1000 DOWN \$181/mo

**2007 FREESTYLE** Cross over w/economy in mind! 20 City 27 Hwy  
 Power exterior mirrors and lock brakes, air AM FM CD trans, 17.5" 5 spoke alloy alum wheel 3.0L I4 V6 Duratec engine P215 65R17 84A tires \$0.50/3rd tire sale \$17.50, 40 mph 3 pass 2nd row Stock #71125  
**Was \$26,360 NOW \$21,724**  
 24 MONTH LEASE RENEWAL  
 SIGN & DRIVE \$267/mo ZERO DOWN \$271/mo \$1000 DOWN \$229/mo

**2007 EXPLORER EDDIE BAUER** 5 STAR RATED 2007  
 V6 safety canopy, electronic mirror message center w/ 4 lines and compass keypad, 4.0L SOHC in-line, 5-speed auto O D trans. Stock #70532  
**Was \$28,995 NOW \$25,161**  
 24 MONTH LEASE RENEWAL  
 SIGN & DRIVE \$308/mo ZERO DOWN \$288/mo \$1000 DOWN \$246/mo

**SUPPORT THE AMERICAN ECONOMY**  
**37300 MICHIGAN AVENUE AT NEWBURGH**  
**WAYNE • JUST EAST OF I-275**



www.demmer.com aplanheadquarters.com

# (800) 817-1706

Authorized **AMDOT** Inspection Facility



**Sales Hours**  
 Mon & Thurs 8 am - 9 pm  
 Tues - Wed & Fri 8 am - 6 pm  
**Service Hours**  
 Monday - Friday 7 am - 6 pm

DISCOVER THE DEMMER DIFFERENCE • DISCOVER THE DEMMER DIFFERENCE • DISCOVER THE DEMMER DIFFERENCE • DISCOVER THE DEMMER DIFFERENCE

# BRIGHTON

## Ford - Mercury Ford

**Authorized ROUSH DEALER**  
15 Vehicles Available!

**JUST ANNOUNCED "FOOSE MUSTANG" IS HERE!**



**REBATES UP TO \$6000**

**0% Financing**  
for 60 Mos. on Select Models  
\*See dealer for details

### ATTENTION FORD EMPLOYEES AND ELIGIBLE FAMILY MEMBERS ~ NOW IS THE TIME TO USE YOUR PROGRAM

#### ESCAPE AND MARINER HYBRIDS IN STOCK

#### 2007 SPORT TRAC XLT 4X4

*Completely Redesigned!*

Was \$28,765  
Now \$22,756

**\$148**

**REBATES UP TO \$3500**

x 24 MO. WITH \$2500 DUE



**ALL NEW!**



Was \$24,015  
Now \$18,599

**\$154**

**REBATES UP TO \$3000**

x 24 MO. WITH \$2500 DUE

#### 2007 FOCUS SES 4 DR

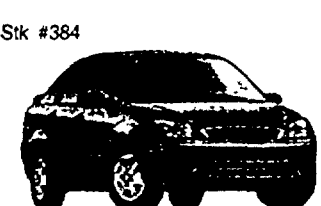

Was \$18,085  
Now \$12,516

**\$89**

**REBATES UP TO \$3500**

x 24 MO. WITH \$2500 DUE



Was \$31,660  
Now \$27,508

**\$212**

**REBATES UP TO \$1500**

x 24 MO. WITH \$2500 DUE

#### 2006 F150 SUPERCAB 4x4 XLT

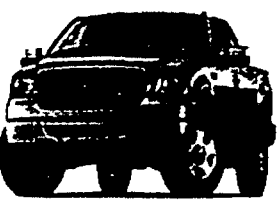

Was \$35,305  
Now \$23,884

**\$102**

**REBATES UP TO \$5500**

x 24 MO. WITH \$2500 DUE

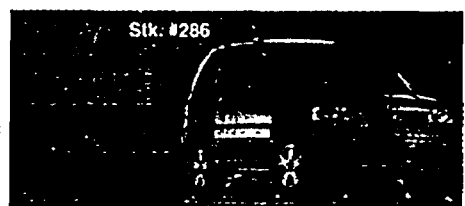

Was \$27,225  
Now \$21,298

**\$162**

**REBATES UP TO \$3000**

x 24 MO. WITH \$2500 DUE

#### 2007 MOUNTAINEER LUXURY AWD



Was \$35,075  
Now \$30,279

**\$246**

**REBATES UP TO \$3000**

x 24 MO. WITH \$2500 DUE



Was \$21,600  
Now \$17,894

**\$146**

**REBATES UP TO \$1500**

x 24 MO. WITH \$2500 DUE

#### 2007 FUSION SE

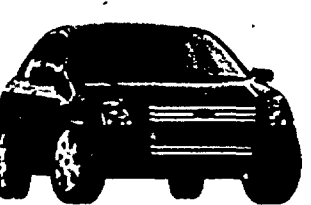

Was \$20,300  
Now \$16,753

**\$133**

**REBATES UP TO \$1500**

x 24 MO. WITH \$2500 DUE

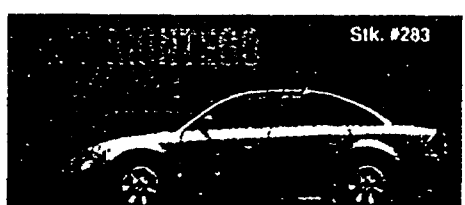

Was \$30,075  
Now \$23,867

**\$236**

**REBATES UP TO \$3000**

x 24 MO. WITH \$2500 DUE

#### 2007 FREESTYLE SEL



Was \$29,425  
Now \$22,460

**\$182**

**REBATES UP TO \$2000**

x 24 MO. WITH \$2500 DUE



Was \$24,670  
Now \$20,005

**\$226**

**REBATES UP TO \$1500**

x 24 MO. WITH \$2500 DUE

#### 2007 MARINER LUXURY 4WD

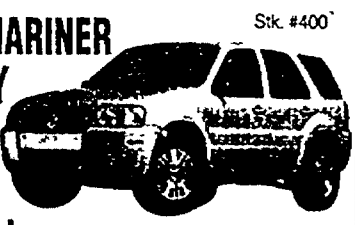

Was \$27,180  
Now \$21,285

**\$170**

**REBATES UP TO \$3000**

x 24 MO. WITH \$2500 DUE



Was \$25,930  
Now \$17,837

**\$369**

**REBATES UP TO \$6000**

x 24 MO. WITH \$2500 DUE

World's Largest FORD-MERCURY DEALER!

# 1-800-836-7697

Or Buy Online

## www.brightonford.com



8240 W. Grand River at I-96

All pricing based on A/Z Plan with UAW Refine Voucher (\$1,000.00) on both purchase or lease. All rebates to dealer including lease renewal program. All pricing plus tax, title, plates. Leases set up at 24 months at 10,500 miles per year. All leases or purchases based on approved credit. All programs subject to change from Ford without notice. Expires September 31, 2006.



OPEN 9-9 MON. Thru THURS. OPEN SAT. 9-4, FRI. 9-7

OPEN 9-9 MON. Thru THURS. OPEN SAT. 9-4, FRI. 9-7

VIEW OVER 30,000 HOMES!

▶ **HOMETOWN***life.com*

**WEEKLY REAL ESTATE**

West

OBSERVER & ECCENTRIC • MIRROR • HOMETOWN WEEKLIES

Thursday, September 14, 2006



**MOCERI**

STRUCTURE • INTEGRITY • TRADITION®

Michigan's Legendary Dream Builder

Cover home offered by Mocerl Companies.  
Please see page 5 for more information  
on this home and others.

**INSIDE** ▶

Real Estate Briefs ... 6 Robert Meisner ... 14

**SOUTH LYON**

Oakland County's Premier  
Resort Style Community

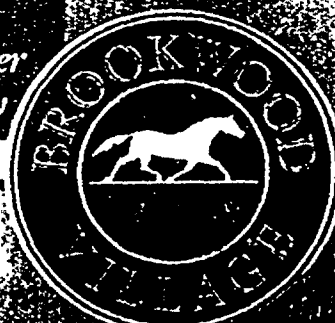

1, 2 & 3 Bedroom Condos  
from the **\$80's!**

Purchase now  
through 9/30/06  
& receive a 42" Flat Screen TV Free!

- Clubhouse & Gym
- Indoor & Outdoor Pools
- Tennis/Basketball Court
- 715 to 1,300 sq. ft.
- Cathedral Ceilings.
- Attached Garages And
- Private Entrances

248-486-2995

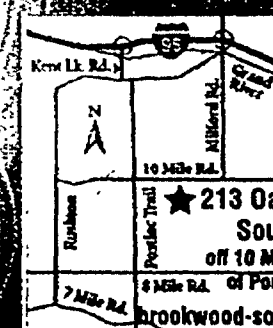

Mon-Fri  
12-5pm  
Sat & Sun  
11am-6pm

★ 213 Oakbrook Dr.  
South Lyon  
off 10 Mile just east  
of Posse Trail  
brookwood-southlyon.com



**COLDWELL BANKER**  
**SCHWEITZER REAL ESTATE**  
 Residential Real Estate  
 10000 E. Grand Ave. #1000  
 Ann Arbor, MI 48106  
**CBS** **CBS**  
 MICHIGAN MICHIGAN

# Everything Real Estate Starts Here... CBSHomeSearch.com



**SALEM** **\$2,499,000**  
 Your own private estate resort on over 2.5 manicured acres. Gourmet Kit. 1st floor Master w/ gas FP. Dramatic 2 story GR. Fin w/out w full kit bath. Inground pool w pool house. Finished living quarters above garage.  
 MLS# 26153003 734-453-6800

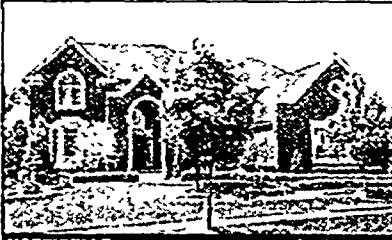

**NORTHVILLE** **\$1,275,000**  
 Lakefront Living! 2 Story foyer kit w/ granite DR w/ butlers pantry solid doors T/O, 2 Story FR w/ tray ceiling mstr Ste w/ sitting area. Fin w/ O w/ full Granite kit, in law Ste & Views Of Teal Lake From Every Window!  
 MLS# 26085412 248-347-3050



**NORTHVILLE** **\$1,200,000**  
 Grand 2 Story Foyer w/ marble Flr, Custom Leaded Front Door. Gourmet Kit w/ granite Counters, Custom Cabs, DR w/ tray Ceiling. 2 Story FR w/ 2 way FP, rear Staircase Sun room. Media room. 5th Bdrm, HW floors. Fin Bsmnt.  
 MLS# 26125222 248-347-3050



**NORTHVILLE** **\$1,200,000**  
 Island Kit w/ built ins, HW floors, Lib w/ cust b/ins. Conserve w/ slate flr/b/ins, cust litng T/O. All Ba upgr, fin w/ O LI w/ 2nd gran Kit, F/P Theatre room. Ba w/ dual Steam Shwr. Sauna. Prof Indsp Brick Terrace w/ stone Flr.  
 MLS# 26030928 248-347-3050



**BRIGHTON** **\$990,000**  
 2 Story Foyer w/ marble floor, gourmet Granite kit w/ sub O. Fridge/freezer, DR, 1st floor bdrm/library, mstr Ste w/ tray Ceiling, private Balcony Off Mstr, glamour BA, 2 Story Great room w/ fieldstone FP, Fin w/ o w/ full Kit.  
 MLS# 26151282 248-347-3050



**MILFORD** **\$679,900**  
 Solarium room. Extends Executive Kitchen To 3 Season Florida Rm. Conservatory Expands The Pictured Elegance Of Lr & Dr. Dual Staircases w/ bridge. Enormous Windows In FR. W/ o Boasts. 2 way FP. theatre grand Bar w/ Kit.  
 MLS# 26152560 248-347-3050



**NORTHVILLE** **\$650,000**  
 2-story foyer w/ ceramic tile. 1st floor mstr w/ tray ceiling. 2 story GR w/ 2-way FP to nook, gourmet kit w/ maple cabs, granite counters & SS appls. upstrs media room or FR or setler will convert back to 4th br. paver patio.  
 MLS# 26148473 248-347-3050



**COMMERCE** **\$575,000**  
 Custom beauty tucked away w/ total seclusion, formal lr w/ tray ceiling hwd fir gran kit, dr w/ crown mldng. 4 season snrm w/ french drs mstr ste w/ dual wics, glamour ba w/ whirlpl tub. guest ste w/ ba, fin LL & patio.  
 MLS# 26131867 248-347-3050



**NORTHVILLE** **\$560,000**  
 Cape Cod On 1 Acre Wooded w/ 1st Flr Mstr ste hwd in foyer, 1/2 Ba, & kit. 2 Story Foyer w/ 2 skylights Gr w/ 1st Flr Indry, unfin Bsmnt, Anderson win, 3.5 Car gar. 2 Furnaces & C/a, paver patio's, & Hearth rm surrm Off Kit.  
 MLS# 26139276 248-347-3050



**NORTHVILLE** **\$539,000**  
 1st Floor Mstr Suite Highly Remod Kit w/ granite. Prof Fin w/ o w/ Kit, Full Ba, BR 4 Or Office, 40x29 Fr Mstr Ste w/ jet Tub, sep Shower, Walk in, Deck. Everything is Highly Maintained & Cared For. Total sq Ft 3820'.  
 MLS# 26134143 248-347-3050



**NORTHVILLE** **\$439,900**  
 SSOk in Upgrades In Kit/baths w/ granite T/O includes Stainless Appl, Maple Cabinetry Kohler Sinks And Faucets. Cul de sac Location w/ priv Front Entrance. Lrg Mstr Has 2 Wic's w/ wood Ceilngs.  
 MLS# 26144040 248-347-3050



**PLYMOUTH** **\$422,900**  
 Colonial w/ neutral Decor. 2 Story Foyer w/ curved staircase. Lrg Island Kit Overlooking Family room w/ FP. Mstr Suite w/ oversized Wic. Mstr Ba w/ Jet Tub. Prof Landscaped Yard w/ deck & paved walkway. 3 Car Garage.  
 MLS# 26110346 248-347-3050



**NOVI** **\$422,900**  
 \$80,000 in upgrades T/O. Gourmet kit w/ ss appls. oversized island granite cntrips & limestone backspash. Fin Daylight Bsmnt w/ bar kitchenette. rec/ent room. full Ba & Connecting Kit. bfst Deck. Porch Paver Patio.  
 MLS# 26144453 248-347-3050

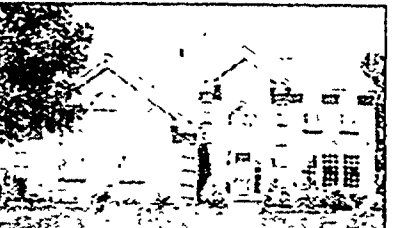

**CANTON** **\$369,000**  
 Central Park Estates 4 BR 2.1 bath Colonial on prem lot w/ mature trees, water fountain new & walking trail. Kit w/ oversized island hwd floors & appls incl FR w/ gas FP. Master w/ lux bath & WIC. LL w/ carpet & RP.  
 MLS# 26144449 734-453-6800



**CANTON** **\$364,900**  
 4 bdrm w/ island kit upgrade adds 4 ft neutral throughout w/ lots of upgrades. Mstr w/ Glamour ba & his/her closets. funds to complete sidewalk grading & install trees in spring. \$10k landscaping allowance included.  
 MLS# 26087979 248-347-3050



**NOVI** **\$360,000**  
 Hardwood floors in foyer hallway kit & FR. Paver patio p fin bsmnt, w/ rec room, cathedral ceiling in FR w/ FP - open to kit, jacuzzi & shower in mstr suite. Corian counters in kit. Also for lease \$2,500 All M/D approx.  
 MLS# 26145524 248-347-3050



**CANTON** **\$329,750**  
 Fabulous 4 BR, 2-1/2 BA Brick Colonial in Glengarry Village backing to mature trees w/ plenty of privacy. Large kit BN w/ lots of cnts-cntrip space. Master w/ cth cig & fash bath. Kit open to FR w/ gas FP. Great lot!  
 MLS# 26151868 734-453-6800



**CANTON** **\$300,000**  
 Transfer forces sale on this Pulte "Princeton" on a low traffic interior setting in one of Cantons newer subs. Dramatic 2 story foyer. Gourmet kitchen. FR w/ gas FP. Master w/ wood cth & fash bath. 2nd floor laundry.  
 MLS# 26136415 734-453-6800

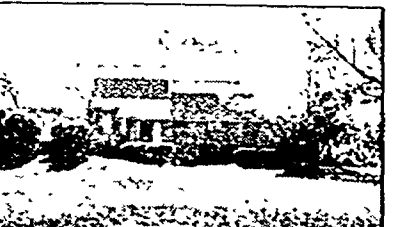

**NOVI** **\$300,000**  
 4 doorwalks Across Back Of Home, Glass Block Accents, Acrylic Spindles. Focal Point Staircase Tile Entry Kit. Br sep Lib. Jack & Jill Bath w/ jetted Tub. Master Bath w/ ig Shower. Floating Vanity In Powder Room.  
 MLS# 26150526 248-347-3050

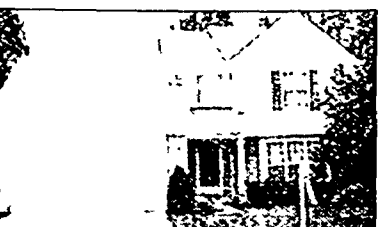

**CANTON** **\$280,000**  
 Interior Lot In Sub Backing To Privacy, Foyer w/ hardwood Flr. Formal LR/DR, Kit w/ eat in Nook & Doorwall To Deck w/ screened Gazebo. hardwood Flr. All appls inc Vaulted FR. Gas FP. Master Ste w/ dual Wic's. Glamour Ba.  
 MLS# 26150623 248-347-3050



**LYONS** **\$270,000**  
 Located on half an acre of land. hardwood floors T/O. Gourmet kit w/ stainless steel appls. 1st flr laundry. Mstr suite w/ WIC. 2 bered deck w/ hot tub. fin full bsmnt w/ lrg rec room, office nook & 4th BR w/ egress window.  
 MLS# 26152323 734-453-6800



**GENOA** **\$269,000**  
 Beautiful home with open floor plan. Fireplace in family room. Great backyard. Close to schools shopping and expressway.  
 MLS# 26091247 248-437-4500



**FARMINGTON** **\$265,000**  
 3 BR bungalow on a private wooded lot 2 blocks from downtown. 1st flr features Brazilian cherry hwd in foyer. DR LR & kit. Fin LL w/ huge FR. All BR's are good sized. New furnace. Newer carpet to Paver w/ ways & patio.  
 MLS# 26137730 248-347-3050



**GREEN OAK** **\$249,900**  
 Home backs to woods, beautiful hardwood floors thru-out. custom kit w/ corian pantry. all appl. Family room has oak FP. in basement. 4 BR 2.2 BA. 5 acres 2.5 ga. age. Mbl. Study updates furnace AC roof.  
 MLS# 26144176 248-437-4500



**PLYMOUTH** **\$239,900**  
 Ponds & mature trees surround unique duplex style homes exude quality & style. Open GR w/ tp huge mstr suite w/ inc. 2nd br has own ba. Loft office area. Daylight bsmnt. Pick your own colors. int. Pics From Model.  
 MLS# 26130903 248-347-3050

ANN ARBOR • BIRMINGHAM • BLOOMFIELD HILLS • CLARKSTON • DEARBORN • GROSSE POINTE HILL • GROSSE POINTE WOODS  
 • COMMERCE/VEST BLOOMFIELD • LIVONIA • MACOMB CENTER • NORTHVILLE • PLYMOUTH • SOUTH LYON • TROY  
 CORPORATE HEADQUARTERS: 3555 S. LEMAY ROAD, SUITE 100, BIRMINGHAM, MI 48226

**COLDWELL BANKER**  
**SCHWEITZER REAL ESTATE**  
 Residential Real Estate  
 A Division of Coldwell Banker  
 12000 E. Grand Ave. Suite 1000  
 Detroit, MI 48202

**CBS**  
 COMMERCIAL BANKING SERVICES

**CBS**  
 COMMERCIAL BANKING SERVICES

# Everything Real Estate Starts Here... CBSHomeSearch.com

**CANTON** \$228,000  
 Stately Brownstone end unit backing to commons! Spacious kitchen, hardwood floors, maple cabinets. Spacious GR w/soaring 9' ceilings & gas FP. 3 BR's on up level w/2 full baths. LL can be used as BR or a nice FR. Loads of upgrades!  
 MLS# 26154409 734-453-6800

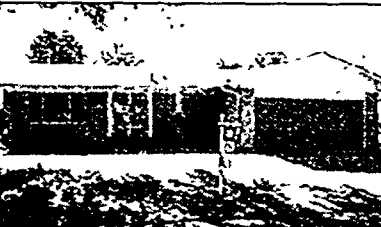

**LIVONIA** \$225,000  
 Eat-in kitchen, huge fam room w/gas FP & drwl to Florida rm. Mstr suite w/access to full BA. HDWD floors under carpet. Updates incl electrical, wtr, furnace, HWH, C/A. Prof landscaped fenced yd. Great fam community w/pool.  
 MLS# 26152780 734-453-6800



**WESTLAND** \$219,900  
 Condo w/3 br, 2.5 bas incl 1st flr mbr w/upgrades galore! Premium ss appl package, ceramic tiled mstr jack-n-jill ba, marble surround fp, library area, backs to the east, premium lot, cathedral ceilings t/o, 2-car garage  
 MLS# 26108924 248-347-3050



**LIVONIA** \$205,000  
 New hardwood floors t/o. Freshly Painted, New Windows T/O. 400 sq ft FR. Updated Ba w/New vanity ceramic Floors & Walls. Priced As if A Foreclosure or bank owned even though it's not. Buyer Agent To Verify All Info  
 MLS# 26144873 248-347-3050



**SUPERIOR** \$205,000  
 Come enjoy the quietness of Superior Twp! 4 BR, 3-1/2 bath Col w tin bsmt offering a family area, office & full bath. Open FR w/gas FP Oak kitchen Master w/WC & bath 4th BR currently a loft. Wooded backyard!  
 MLS# 26153491 734-453-6800



**PLYMOUTH** \$204,900  
 Unique Duplex Style Homes Exude Quality & Style. Open Great room w/FP. Huge Master Suite w/WC. 2nd Br Has Own Bath. Spacious Loft/office Area. Daylight Bsmnt. Pick Your Own Colors & More. Plymouth schools.  
 MLS# 26130845 248-347-3050



**LIVONIA** \$200,000  
 Updated Brick Ranch. Updates incl remodel Kitchen & Baths. Part Fin Basement. HDWD Foyer To Kit. HDWDS T/O Under Carpet Cedar Deck & Extensive Landscaping. Newer Apps Stay C/A. Nat Fp. Mstr Br Ba. 4th Br In Bsmnt!  
 MLS# 26146587 734-591-0333



**HOLLY** \$199,500  
 Beautiful brick ranch in Holly with open floor plan. 3 Bedroom/2 bath. Newer windows and doors, new hardwood floors in kitchen and dining room. Fabulous deck and covered patio. On double lot. Must see!  
 MLS# 26132154 248-360-1425



**WESTLAND** \$180,000  
 Gorgeous contemporary 3 BR colonial. Open flr plan, FR w/FP & cath cig Kit w/ceramic tile spacious master ste w/vaulted cig & WC. Fin LL w/lg rec rm. Prof landscpd yd w/sprinkler sys. This home is extremely clean!  
 MLS# 26143533 734-453-6800



**SALEM** \$179,900  
 One of 11 lots for sale. Paved roads. Established sub. Lots from 2.5 to 8.39 acres. Priced \$169,900 to \$225,000. South Lyon Schools, Salem Twp taxes.  
 MLS# 26117086 248-437-4500



**TAYLOR** \$175,000  
 Spotless 3 Bdrm 2 Bath! Family room w/Fireplace. Master Has Sitting room and 2 Closets. Other Bdrms Have Hardwood Floors. Oak Cabinets. Glass Block Windows in Bsmnt. Patio. Huge Yard. 1 Yr Home Warranty Included.  
 MLS# 26142277 734-591-0333



**REDFORD** \$174,900  
 Cute bungalow sitting on almost 1 acre can be your home or keep the tenant that's there now & have a great investment property. Offers newer wtr copper plumbing newer roof & hvac. seller will consider land contract.  
 MLS# 26094942 248-347-3050

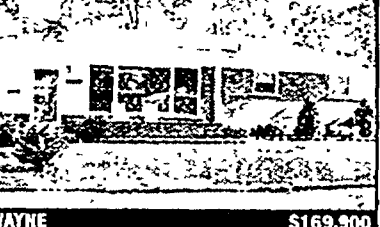

**WAYNE** \$169,900  
 Spacious 3 BR 2 BA Ranch prem location backs to woods. Newer to roof, wndws gutters furn kit. Some apps stay. HDWD floors under carpet. Fin bsmt w/lge glass blk wndws for light & lots of storage. Fenced yd, 2.5 car gar.  
 MLS# 26153023 734-453-6800



**LIVONIA** \$165,000  
 Country Living In The City! On Over 1/2 Acre In Livonia. 2 Car Garage & A Part Finished Bsmnt w/poss 4th Bdrm. Updates Roof Windows, Kit & Bath. Driveway On Pinetree For Easy Access. C/A. Lot May Be Splittable.  
 MLS# 26153547 734-591-0333



**NORVELL** \$165,000  
 Great Opportunity To Own A Home Off Vinyard Lake. 2 Story Colonial. Updates Include Kitchen Doors Baths Flooring Furnace Privacy Fence Well Pump Paint Deck. Some Windows Enclosed Porch Deck, 2 Sheds & More.  
 MLS# 26135077 734-591-0333



**WESTLAND** \$165,000  
 Sharp Condo In Brownstones Of Westland Has Master Bath, Open floor Plan. H/wood floors, Vaulted Ceiling In Bdrms. Finished Lower Level With 1/2 Bath, Possible 3rd Bdrm. Att gar. Completes This Beautiful Condo.  
 MLS# 26144373 734-591-0333



**REDFORD** \$160,000  
 New gourmet kit w/ceramic & maple cabinets. New HDWD flr t/o. Huge master suite w/ceiling fan W/C, sitting area & private bath. Newer windows. newer furnace. C/A & 6 panel doors. Fenced yard w/patio.  
 MLS# 26154481 734-453-6800



**NOVI** \$145,000  
 New Jacuzzi Tub. New flooring. New Lighting T/O, New courtyard, Newer Apps (except Dryer). New flooring in kit & Entry. Balcony Off master bedroom.  
 MLS# 26137039 248-347-3050



**YPSILANTI** \$140,000  
 Unbelievable value! Check the comps, 1872 square feet! Enormous FR w/ceiling fans. Formal DR. gourmet kitchen w/all appliances to stay. Master suite w/ceiling fan. Updates incl furnace H2O windows and roof.  
 MLS# 26153105 734-453-6800



**GARDEN CITY** \$139,900  
 The windows, roof siding gutters. C/A & H2O tank have been updated. You'll love the neutral decor. the bsmt is part fin. All appliances stay including a portable dish-washer, stove, fridge, washer & dryer.  
 MLS# 26159843 734-591-0333



**REDFORD** \$137,900  
 3 BR 2 Ba Brick Ranch. Deep Fenced Yard. 2.5 car Garage. W/workbench. Many Updates Include Kit, Paint, Carpet, Tile. Driveway & more! 3rd Bm Can Be Used As Formal DR. Knotty Pine Fin Bsmnt W built ins. all apps.  
 MLS# 26149231 248-347-3050



**REDFORD** \$124,900  
 Over 1300 sq ft In This 3 Bdrm Ranch Home Home Sits On an Extra Large Lot & Has A Great 3 Car gar With An Att summer Florida Room. Home Offers Large Bdrm Sizes. Custom Lighting in Kit. apps & Separate Din Area.  
 MLS# 26144008 734-591-0333



**CANTON** \$123,900  
 Attention 1st time buyers! Why rent when you can own this gorgeous Condo? 2 BR, 1.5 baths, fireplace full basement private deck & 2 carports! Seller will pay 1 years Home Owners Association w. acc offer!  
 MLS# 26154946 734-453-6800



**REDFORD** \$95,000  
 This One Is A Steal! Great For First Time Buyers!!! Move-in Condition. Virtually No Work To Be Done. Neutral T/O W. Updated Bath W Ceramic Flooring. Part Fin shed. Basement Close To Schools. Appliances Included.  
 MLS# 26145175 734-591-0333



**SOUTH LYON** \$49,900  
 Very Clean Move In Ready Adult Co Op. 2 Bedroom 1-1/2 Bath Ranch Unit w/Finished Basement. Large Pabc Enclosure w/ Carpet & Mini Blinds. Beautiful Club House & Pool.  
 MLS# 26160044 734-591-0333

**COLDWELL BANKER**

SOLD

**COLDWELL BANKER**

All Real Estate Companies are not the same!

# DISCOVER THE DIFFERENCE PROFESSIONALISM. SATISFACTION. RESULTS.

View Thousands of Available Homes in Your Area

On Our Website @ [www.cbpreferred.com](http://www.cbpreferred.com)

PREFERRED, REALTORS

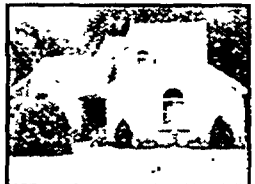

**CUSTOM HOME ON WOODED LOT** Popular Huron Hills sub boasting custom features like circular round top windows 2 decks oversized garage, paver walkways and more Premium location Great Cape Cod floor plan with 3 bedrooms 2.5 baths  
**\$299,900 (P-630HU)**



**NICE HOME** Nice starter w/ plenty of possibilities Updated roof, furnace, & hwh Insulated garage w/220, 50x202 lot & more  
**\$104,900 (C-151AL)**



**GREAT STARTER HOME** Bright & clean on an extra deep lot Brick ranch w/ updated Kitchen, bath, windows, roof, deck, garage & a beautiful yard All appliances stay!  
**\$121,990 (P-936GA)**



**CENTRAL PARK STEAL** Terrific colonial w/2 story brick elevation, volume ceilings, hardwood floors, large island Kitchen, Great Room, 1st floor laundry, oversized master w/ bath & professionally landscaped  
**\$354,900 (P-396SP)**



**BEAUTIFUL COLONIAL** Nestled on a quiet, large wood lot Neutral décor thruout, updated vinyl windows, Family Room with fireplace & cath ceiling, 6 panel doors thruout newer carpet, updated bath, 1st floor laundry & updated oak Kitchen  
**\$319,900 (P-412ST)**

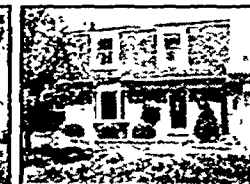

**CANTON COLONIAL** Wonderfully updated 3 bd colonial in popular Winsor Sub Hardwood floors in Living Dining, & Family Room, finished basement, private backyard, beautifully landscaped, & all appliances stay.  
**\$229,900 (P-860AR)**

**CANTON**  
**CANTON CONDO** 2 bd, 2 bath condo w/possible 3rd bd on lower level. Open floor plan, island Kitchen, Balcony, finished walkout, Master w/WIC, & good location.  
**\$235,900 (P-796CH)**

**GARDEN CITY**  
**MOVE RIGHT IN!** Updated thruout New furnace, hwh, 6 panel maple doors, decorator paint thruout, updated bath, new windows, Pato, fresh landscaping, Garage, siding & trim, & much more!  
**\$125,000 (P-645SH)**

**CANTON**  
**CARE FREE CONDO** End unit condo with first floor Master, 2 full baths, cathedral ceilings, 1st floor laundry, basement, 2 car Garage, freshly painted, & appliances stay.  
**\$149,900 (P-870HU)**

**INKSTER**  
**CURB APPEAL PLUS!** Maintained brick ranch w/2 bd, 2 baths, & could be converted back to a 3 bd Nicely decorated, finished basement, new furnace, a/c, windows, fenced yard & appliances  
**\$99,900 (C-994GL)**

**CANTON**  
**SIMPLY IRRESISTIBLE** No need to wait for builder on this almost new 2 bd, 2 bath town home in the Links at Fellows Creek. Great Room with fireplace, Kitchen with all appliances, & balcony.  
**\$159,900 (P-071KM)**

**INKSTER**  
**WELL MAINTAINED** 3 bd ranch w/ newer windows, furnace, roof, hwh, neutral carpet & décor, & updated bath. 1 year home warranty  
**\$109,900 (P-6425T)**

**CANTON**  
**OUTSTANDING SETTING** Stunning Burlington model situated on a village lot backing to walking/bike path. Upgrades thruout, gourmet kitchen, Conran, hardwood, 2nd floor laundry, & more.  
**\$449,900 (P-578MC)**

**LIMA TOWNSHIP**  
**WOW!** Well maintained ranch on almost an acre Oversized Garage, Kitchen w/Pato door to Florida Room, huge yard, hardwood, & wide open finished basement.  
**\$185,000 (C-3800L)**

**CANTON**  
**STUNNING CAPE COD** Beautiful Cape Cod w/2 story Foyer, GR with fireplace, vaulted ceilings, hardwood floors, Master w/WIC's, & professionally landscaped w/ sprinklers  
**\$274,900 (P-775PA)**

**DEXTER**  
**COUNTRY ESTATE** 10 acre estate w/stunning 3500 sq ft home. Formal LR & DR, Master w/WIC's, gourmet Kitchen, walkout basement with fireplace, oversized Deck w/gazebo, & 3 car Garage.  
**\$999,000 (P-998STO)**

**CANTON**  
**PRISTINE COLONIAL** Stunning 3 bedroom, 2.5 bath home Master suite w/ cathedral ceiling, walk-in closet & full bath Large deck, finished basement, & appliances stay!  
**\$259,900 (C-866CR)**

**LIVONIA**  
**GORGEOUS RANCH** Updated brick ranch backs to woods. Superb finished basement, newer carpet, windows, doors, roof, & furnace Open floor plan, neutral décor, & quiet location.  
**\$199,900 (C-032BR)**

**CANTON**  
**PERFECT CONDO** Great for 1st timers! Crown moldings, Pergo, all appliances stay, balcony spacious bedrooms, & great location.  
**\$102,900 (P-419SA)**

**LIVONIA**  
**MOVE-IN CONDITION** Cute condo decorated w/designer colors. Hardwood floors, Garage, library study area, GR wired for surround sound Pato, & much more This will not last!  
**\$184,900 (C-110NE)**

**CANTON**  
**MOVE RIGHT IN!** Updated condo w/2 bd, 1.5 baths, updated Kitchen, cathedral ceilings, skylights, partially finished basement, & a private courtyard  
**\$134,900 (P-382SO)**

**LIVONIA**  
**WELCOME HOME** Outstanding brick ranch w/3 bd, 2 baths, finished basement, updated maple Kitchen, & huge backyard 1 year home warranty for Buyer  
**\$199,900 (C-610OH)**

**CANTON**  
**WELCOME HOME** Elegant home featuring a formal LR & DR, Family Room, Home Theater area, 4 bd 3 full & 3 half baths, & 3 car Garage  
**\$469,900 (C-874LI)**

**LIVONIA**  
**NEWBURGH LAKES CONDO** Spacious 1st floor end unit w/ neutral décor Very clean, huge master w/WIC, & all appliances are included Excellent location.  
**\$95,500 (C-192AM)**

**GARDEN CITY**  
**FABULOUS LOCATION** 3 bd home on acre corner lot. Updated maple Kitchen, custom ceramic, & updated bath Extensive landscaping brick pavers, 2 car garage pool, deck & privacy fence  
**\$144,900 (P-116AL)**

**LIVONIA**  
**SPACIOUS END UNIT** Livonia condo w/soaring ceilings, GR with fireplace, Kitchen w/Conran, 1st floor laundry, 1st floor Master w/ bath, full basement, & Garage Neutral décor & new carpet.  
**\$225,000 (P-323EA)**

**GARDEN CITY**  
**ALL UPDATES DONE** Clean & updated brick ranch Updates inc windows, roof, furnace, hwh, paint, & glass block. Large Kitchen, updated bath, large basement, 2 car Garage, & oversized lot  
**\$145,000 (C-223DE)**

**LIVONIA**  
**SHARP CONDO** Nice floor plan offering 2 bd, 2 baths, cathedral ceilings, covered balcony, & all appliances stay Home warranty for buyer  
**\$139,900 (P-866FT)**

**GARDEN CITY**  
**A MUST SEE!** Great colonial w/ open floor plan, large LR & FR, Deck w/large pool, basement, updated windows, carpet, & roof  
**\$179,900 (P-110KA)**

**LIVONIA**  
**BRICK RANCH** Huge private lot w/ deck, updates inc new Kitchen, furnace, paint, carpet, 4 large bdms, & excellent location. Also for lease  
**\$184,900 (P-214MQ)**



**PRESTIGE & PERFECTION** Northville ranch condo w/tons of extras 2 bd 3 baths, grand Master Suite, finished basement with 2nd Kitchen expansive view from 3 season room, & more  
**\$434,900 (P-785AS)**

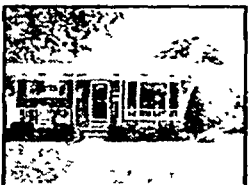

**POPULAR LIVONIA SUB** Beautiful 4 bd 2 bath ranch w/updated Kitchen & bath, newer roof furnace, entry doors cement windows, plumbing, hardwood, & much more A lot of house for the price!  
**\$192,895 (C-182FO)**



**A RARE JEWEL** Close to downtown Plymouth & shopping 3 bd condo w/ finished basement, garage, updated Kitchen, some new carpeting formal dining room, gas fireplace, & enclosed courtyard  
**\$184,900 (P-854LY)**



**SHARP BUNGALOW** 3 bd, oversized Master, country Kitchen with appliances, rec room in basement, updated baths, flooring, windows, hwh, furnace vinyl siding, privacy fence, landscaping, & huge lot w/2 sheds  
**\$96,900 (C-327GL)**



**ELEGANT CAPE COD** Nestled in a private wooded setting Architectural details abound, marble & granite kit, palladium windows, heated floors, finished walkout, recessed lights, enchanting garden room and all the modern conveniences  
**\$894,900 (P-319HI)**



**WONDERFUL OPPORTUNITY** This full brick ranch is larger than most & ready to move in now! Maintenance free extenor, open floor plan w/3 bd, 1.5 baths, updated Wallside windows, entry doors, & 2.5 car Garage w/ opener.  
**\$159,900 (P-747OS)**



**MOVE RIGHT IN!** Beautifully updated Canton condo w/2 bd, 1.5 baths updated Kitchen cathedral ceilings skylights fireplace partailly finished basement & a private courtyard Call today!  
**\$134,900 (P-382SO)**



**GREAT VALUE** Cute home on quiet dead end street 1230 sq ft home, Many improvements inc kitchen, driveway patio, 2 full baths w/tile & oversized 2.5 car garage Home Warranty  
**\$134,900 (P-057WI)**

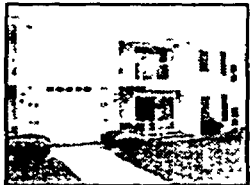

**EASY LIVING** 2 bd, 2 bath condo w/large Master Suite, newer windows large balcony updated Kitchen & baths, appliances stay, ample storage space & carport Assoc dues include heat & water!  
**\$127,500 (P-240AN)**



**OLD WORLD CHARM** You'll fall for this 1st floor Master Cape Cod w/warm Great Room, expansive windows, large Kitchen, recessed lights, Den formal Dining, 1st floor laundry, & 3 car Garage  
**\$469,900 (P-972TA)**



**WESTLAND RANCH** Beautifully remodeled ranch w/newer windows & custom window treatments, flooring, carpet, & more Newer patio in backyard, move in condition Ready to move right in  
**\$99,900 (C-132CA)**

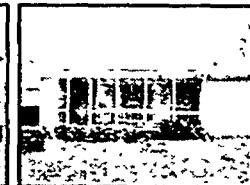

**COUNTRY LIVING** 1600 sq ft ranch sitting on 10 rolling acres 3 bd, 1 bath living room with fireplace, Den, Formal Dining & 2 car Garage  
**\$259,900 (P-718CO)**

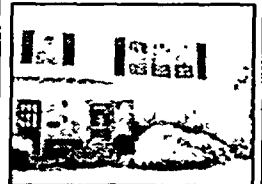

**IT'S ALL HERE!** Completely remodeled condo! New Kitchen cabinets new bath w/ pedestal sink vinyl windows hardwood floors & awesome location close to everything  
**\$75,000 (C-525TH)**

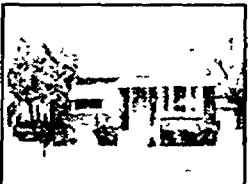

**MOVE IN READY** 3 bd brick bungalow featuring newer windows updated Kitchen, formal Dining LR w/day window part finished basement, & seller can help w/ closing costs City Certs Done!  
**\$110,000 (C-452AR)**



**AMAZING HOME** Lovely South Lyon location 4 bd 3.5 baths, gourmet island Kitchen, vaulted Master w/bath & WIC daylight basement, 3 car Garage, professionally landscaped & much more  
**\$344,900 (C-373DR)**



**TURN KEY CONDO** Lavishly updated condo complete with all the upgrades All appliances included pond views from the Deck Move right in  
**\$159,999 (C-882HA)**



**ENTERTAINING** Enjoy the summer in your new home with ah a pool & hot tub! Loaded w/updates Hickory Kitchen w/granite, berber carpet thruout windows, oversized bedrooms & super clean  
**\$149,500 (C-232SH)**



**NOVI CAPE COD** Gorgeous 4 bd, 2.5 bath home built in 2000 Spacious island Kitchen, Family Room with fireplace 1st floor Master 1st floor laundry, finished basement, stamped concrete Patio & so much more  
**\$350,000 (C-291HO)**



**BEAUTIFUL START** Price reduced on this west Dearborn home Loads of features, spacious Living Room with fireplace formal dining hardwood floors remodeled Kitchen, partailly finished basement, & great location  
**\$139,900 (C-828LO)**



**SPACIOUS BUNGALOW** Looking for space? Here it is! Fantastic 4 bd home w/cover ceilings hardwood floors finished basement 2.5 car Garage Deck & Patio A must see  
**\$159,900 (C-600NA)**



**DOWNTOWN NORTHVILLE** Wonderfully remodeled 3 bd 2 ba home Remodeled Kitchen with Pergo flooring, ceramic baths new carpet, new furnace & C/A updated electrical, plumbing siding & so much more A must see!  
**\$218,900 (C-326PE)**

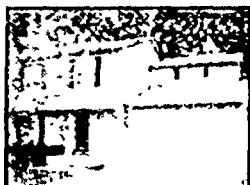

**WESTLAND'S HIDDEN JEWEL** Private wooded view on a quiet cul de sac backing to Hines! Built in '94 this 3 bd beauty offers a spacious neutral floor plan finished basement, sprinklers & lots more  
**\$182,500 (C-358PE)**



**COPPER CANYON CUTIE** 3 bd bungalow w/finished basement updated Kitchen & Bath new carpet enclosed porch updated roof shingles electric service & a 2 car Garage A super buy!  
**\$99,900 (C-280RO)**



**ESTATE BUILDING SITE** Complete privacy on this 10 acre parcel in Salem Twp Wooded walkout site w/ serene views Plymouth Canton schools close to expressways Call for further details  
**\$279,900 (P-000CUB)**

**NORTHVILLE/NOVI**  
**(248) 305-6090**

**CANTON**  
**(734) 392-6000**

**FARMINGTON**  
**(248) 478-6022**

**WESTLAND/GARDEN CITY**  
**(734) 392-6000**

**PLYMOUTH**  
**(734) 459-6000**

**LIVONIA**  
**(734) 425-6060**



**Granite Countertops Included PLUS \$7000 In FREE Upgrades**



**LAKESIDE** Custom Homes from \$293,400

**MARTINDALE** Custom Homes from \$259,900

**ARBORS OF LYON** Custom Homes from \$295,000

- New communities
- Award Winning schools
- Conveniently near I-96
- Low taxes
- Unique Floor Plans

**TONY VAN OYEN**  
Builder, Inc.

Sales Center at *Arbors of Lyon*  
248-437-2070 Open Daily 12-6pm  
[www.TonyVanOyenBuilder.com](http://www.TonyVanOyenBuilder.com)

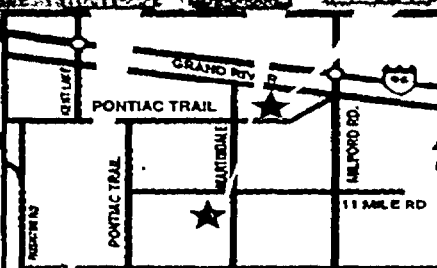

## LUXURIOUS CONDOMINIUM HOMES

From \$209,900

**GRAND  
OPENING  
SPECIAL**  
\$2000 of  
FREE  
upgrades!

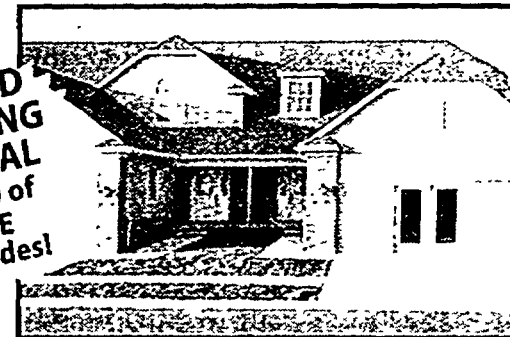

### New Construction Condos in New Asbury Hill Village

- Ranch or Cape Cod style homes
- Highly acclaimed South Lyon Schools
- Daylight and Walk-out sites
- Gourmet Kitchens with appliances
- Granite Countertops throughout
- Vaulted Ceilings
- Hardwood Floors
- Quick occupancy available
- Close to Expressways
- Near Kensington Metropark

Located on Grand River Ave.  
west of Martindale

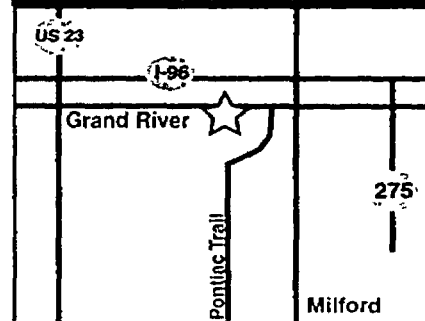

Join us for our **GRAND OPENING CELEBRATION**

Saturday, Sept. 16<sup>th</sup>  
noon-6pm



For more information, call:

**Jan Raupp 248.981.6348**

or

**Peter Argenta 248.719.3980**

Open Fri., Sat. & Sun. 1-5pm or by appointment

**Real  
Estate  
One**

## Homes That Dreams Are Made Of...

*Extraordinary Environments, Envidable Neighborhoods  
and Unsurpassed Craftsmanship.  
Experience the Dream of Living in a Mocerri Home.*

VISIT OUR 2007 MUST-SEE MODEL DESIGNED BY  
RENOWNED INTERIOR DESIGNER MICHAEL FORAN.

### GRAND ESTATES HOMES

From the low \$600's  
to over \$2 million

Kingsridge & Kirklands  
248-373-6200

Carrollton Hills  
248-656-0800

### DUET CONDOMINIUMS

From the \$420's  
Claremont 248-601-3640

### EXQUISITE VILLAS

From the \$500's  
Cloisters 248-601-3001

Located along  
Silverbell Road  
and Adams Road

Models Open Daily  
Noon-6

Visit [mocerri.com](http://mocerri.com)

# MOCERRI

STRUCTURE • INTEGRITY • TRADITION®

*Michigan's Legendary Dream Builder*

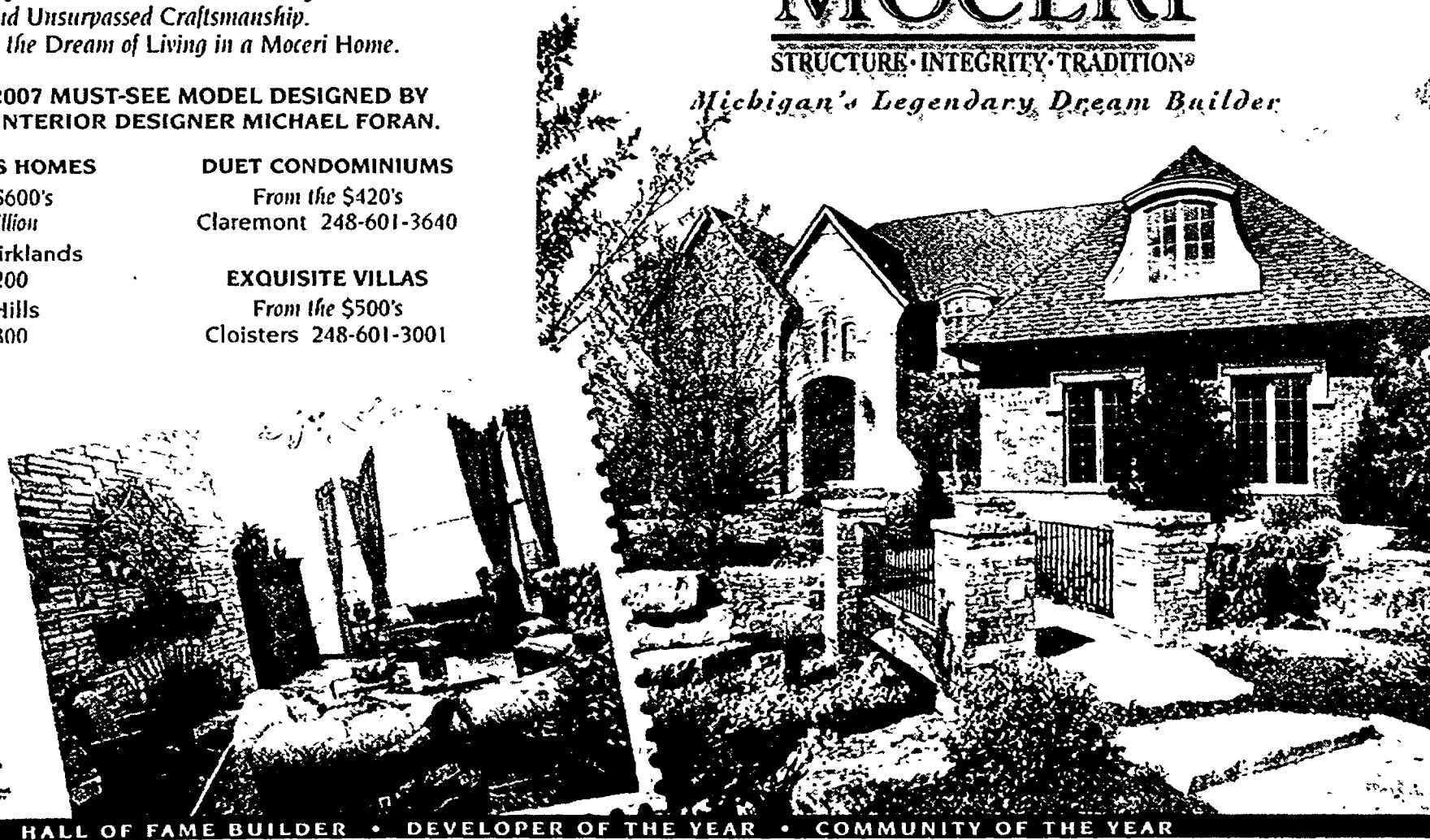

HALL OF FAME BUILDER • DEVELOPER OF THE YEAR • COMMUNITY OF THE YEAR



HOMETOWNLIFE.COM

## Weekly Real Estate

### HOW TO REACH US

**Peter Neill**  
Vice President / General Manager  
(734) 953-2252  
pneill@hometownlife.com

**Julie Brown**  
Editor  
(734) 953-2111  
jcbrown@hometownlife.com

### Advertising Information

**Observer & Eccentric**  
**Marty Carry**  
(734) 953-2150  
mcarry@hometownlife.com

**Hometown Weeklies**  
**Grace Perry**  
(248) 349-1700, ext. 120  
gperry@gannett.com

**Mirror Newspapers**  
**Elaine Myers**  
(248) 546-4900, ext. 268  
esmyers@hometownlife.com

### Career Seminar

Keller Williams Realty will host a Career Seminar 6:30 p.m. Tuesday, Sept. 19, at the Plymouth office, located at 40600 Ann Arbor Road, Suite 100, Plymouth. RSVP: (734) 459-4700.

### Buying a home

A Free Homebuyer Class will be 6:30 p.m. Tuesday, Sept. 19, at Fidelity National Title at Six Mile and I-275. It is put on by Rosemary Firestone of RE/MAX 100 and Michael Firestone of Golden Mortgage. A home inspector will be present. Attendees are both first-time home buyers and experienced buyers. It covers why it is important to be pre-approved and what that entails; what kinds of mortgages are available and to whom; how to avoid a "lemon" and have the house inspected professionally; have a buyer's agent working only for you - not the seller; how to get seller's concessions to help cover your costs; how to decide on a good offer price. Call for reservations (24 hours) at (734) 420-9600 or e-mail at: info@rfirestone-team.com.

### Investment Property

Buying Investment Property: free seminar. Topics will include buying a foreclo-

## REAL ESTATE BRIEFS

sure, fix and flip vs. rental properties, lease/option to buy and financing. The seminar will be 7-8 p.m. Tuesday, Sept. 26, at Metropolitan Title, 134 N. First St., Brighton. Call Diane Adamick at (734) 455-2219, Ext. 217, to register.

### Builders Institute

The Oakland Builders Institute will offer:

■ A 16-hour seminar to help you pass the Michigan state builder's license examination by Lake Orion Community Education and the institute, 6-10 p.m. Tuesday/Thursday, Sept. 26, 28, Oct. 3 and 5, in the Community Education Resource Center, 455 E. Scripps in Lake Orion. The course is for those who want to subcontract the construction of their own homes, real estate investors and developers and building tradespeople. Cost is \$199 plus \$20 for textbook and sample questions. Pre-registration with payment by Sept. 22 to Lake Orion Community Education, (248) 693-5436.

■ A 16-hour seminar to help you pass the Michigan state builder's license examination by Royal Oak Community Education and the institute, 6:30-9:30 p.m. Monday/Wednesday, Sept. 25, 27, Oct. 2, 4 and 9, at Kimball High School,

1500 Lexington, Royal Oak. The course is for those who want to subcontract the construction of their own homes, real estate investors and developers and building tradespeople. Cost is \$199 plus \$20 for textbook and sample questions. Pre-registration with payment by Sept. 21 to Royal Oak Community Education, (248) 588-5050. For more, visit online at www.buildersinstitute.com.

### Building Industry Association

The Building Industry Association of Southeastern Michigan is offering:

■ "Real Estate Continuing Education" course as part of the Sales & Marketing Council, 8:30 a.m. to 3:30 p.m. Wednesday, Sept. 20 and Oct. 18, at BIA headquarters, 30375 Northwestern Highway, Suite 100, Farmington Hills. Lori Chmura of Middleton Training is the instructor. Each daylong course meets state-mandated requirements for six hours of continuing education. Fee is \$60 for SMC members, \$80 for BIA or Apartment Association of Michigan members. To register, call (248) 862-1033.

■ Field Superintendent course on



PLEASE SEE BRIEFS, 12



"It's the best time to invest in Michigan."



The Real Estate One Family of Companies  
Real Estate One • Mar Beck & Partners • Johnson & Johnson  
Century 21 Insurance Agency • Insurance One Agency  
Century 21 Mortgage Company • Education America

 <p><b>Southfield</b> STYLISH RANCH W/GREAT FLOOR PLAN! HWF, Wet plaster walls w/ cove ceilings, updt'd kit, bath. Newer windows, roof. Fresh paint in/out. Beautiful patio and walkway. Birmingham schools. (26121948) \$129,990 Stacey Reese 248-770-0930</p>	 <p><b>Novi</b> GORGEOUS DETACHED 3 BDRM CONDO. Lovely Great room w/ cathedral ceiling &amp; frplc. Mstr suite w/ jacuzzi, kitchen boasts granite counter tops &amp; more. (26132341) \$279,900 Carolyn Bailey 313-910-8162</p>
--	--

 <p><b>Lake Orion</b> Come see elegant! Spectacular 1.5 Acre lot. Grand entry, ceilings. Inground pool. Mstr suite. Chic, lg. kitchen. Fabulous GR. (26090145) \$425,000 248-652-6500</p>
--

 <p><b>Beverly Hills</b> Fantastic location backs woods! 1st Floor mstr plus 2 bedrooms &amp; 16' x 10' loft up. 3-Way fireplace. granite in gourmet kitchen. Brick paver patio &amp; walk. (25161727) \$384,000 248-652-6500</p>
---

 <p><b>Lake Orion</b> Easy access to M24 &amp; I75. 4 BR/2.5 BA/2+ car gar/ lg bsmt/cathedral ceiling in MSTR STE/ lg island kit. Located in sub of higher priced homes. FR, den, dining. (26051492) \$254,000 248-652-6500</p>
--

 <p><b>Keego Harbor</b> BRAND NEW CONSTRUCTION with West Bloomfield schools! Beautiful 4 bedroom home in great family sub. Landscaping and sprinklers included. Privileges on Dollar Lake, access to Cass Lake. (26044698) \$289,900 Brenda Zack 248-939-2076</p>
--

 <p><b>Rochester Hills</b> Great condo, beautiful complex! 2 BR/2 1 bath/1328 sq ft. with a full basement and 1-car garage &amp; private, fenced backyard. Easy shows, call today! (26095404) \$139,900 248-652-6500</p>
---

 <p><b>Orion Twp</b> 5 Gorgeous rolling &amp; wooded acres on Paint Crk Trail. Splitable property. Charming 3 BR/3 BA home. W/o bsmt, 2.5 car gar. Fenced pasture. Barn. Fab location! (25137494) \$289,000 248-652-6500</p>
---

 <p><b>Clarkston</b> Completely renovated 4 BR, 3 1/2 bath home on private, wooded 3-acre site. Minutes from downtown Clarkston &amp; highways. Stunning MSTR STE, Clarkston Schools. (26055226) \$375,000 248-652-6500</p>
--

 <p><b>Ferndale</b> 1925 Bungalow. Remodeled gourmet kit. 03 Upstairs bath prof done. 04 DR &amp; LR w/hdwd flrs. Newer windows, copper plumbing, air, water heater, furnace, carpet, etc. (26067907) \$134,900 248-652-6500</p>
--

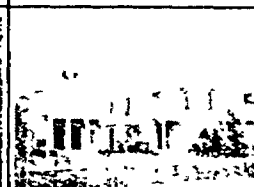
 <p><b>Oakland Twp</b> Fabulous deal on this upscale 2 BR/2 BA condo barely lived in. Condo tours stainless appls, granite snack bar &amp; fireplace. Rochester Schools/1533 SF/att gar. (26114897) \$180,000 248-652-6500</p>
---

 <p><b>South Lyon</b> ATTENTION INVESTORS! 16 1/2 acres with 2 br house. Spacious kitchen, lg enclosed porch. 8 stall barn. Pole 40 x 30 &amp; fenced pasture. Close to school &amp; town. (26131386) \$580,000 Virginia Martin 248-578-0113</p>
---

 <p><b>Livonia</b> VERY NICE 4 BR LIVONIA COLONIAL. Close to parks shopping &amp; golf. Lovely family room w/ frplc. updated kitchen w/ oak cabinetry. Formal dining room &amp; more. (26094322) \$239,900 Carolyn Bailey 313-910-8162</p>
---

 <p><b>Brighton</b> GOLFER'S DREAM HOME IN OAK POINTE! Fabulous cape cod overlooking 6th green of championship course. Gorgeous views. Lovely 1st flr mstr suite. Fantastic fin walk-out LL &amp; more. (26156138) \$434,900 Carolyn Bailey 313-910-8162</p>
---

 <p><b>Ortonville</b> Exceptional custom home/2 1/2 acres/priv wooded setting. Beautifully landscaped/screened-in porch/many updt's &amp; energy efficient. W/O bsmt LL ready to be finished. (26087811) \$319,900 248-652-6500</p>
--

 <p><b>Novi</b> SHARP 2 BR RANCH CONDO W/1 CAR ATT GAR. Many nice updates &amp; all appliances are included. Enjoy pool, tennis courts and club house. (26061794) \$116,900 Anita Alden 248-872-7668</p>
--

 <p><b>Rochester Hills</b> Great Kings Cove condo! 3 Bedrooms/2 1/2 baths. All updated. Formal dining room, living room with FP. Kitchen with nook. Call today-you won't be disappointed! (26071254) \$169,900 248-652-6500</p>
--

 <p><b>Livonia</b> HOME SWEET HOME! Charming cape cod on beautiful 1.5 acres. Backs to Bell Creek. Lovely perennial gardens adorn the inground pool. Living room w/ frplc, SBR, 2 SBA. Updates galore. (26154051) \$440,000 Carolyn Bailey 313-910-8162</p>
--

 <p><b>Redford</b> SPACIOUS UPDATED 1425 SQ FT BUNGALOW. Great open floor plan. Updates throughout include both roofs vinyl siding, windows, oak kitchen cab &amp; floor, both baths and electrical. Lg mstr w/WIC. (26106955) \$144,900 Anita Alden 248-872-7668</p>
--

 <p><b>South Lyon</b> QUIET COUNTRY LIVING. Ranch home w/4 br, finished basement, 8.06 acres, lg barn w/8 stalls &amp; water, 1 sm barn, garage 56'x24'. Newer furnace, new pump on well. (26131421) \$340,000 Virginia Martin 248-578-0113</p>
--

*Don't Miss The Chance To*

*Own The Home Of Your Dreams  
At Prices Below What You Would Expect.*  
The Most Important New Home Buying Event In  
The History Of Farmington Hills Has Begun.



*The Preferred Purchaser Event  
At Legacy Oaks*

A Select Gallery Of Only 24 Limited Edition Homes  
Spread Over 11 Spectacular Wooded Acres

Now Taking Preferred Purchaser Registrations

Don't Miss Your Opportunity To Purchase One of Only 24 Homes  
At The Best Pre-Construction Pricing!

Call: 248.388.1599

Log Onto: [LegacyOaksHomes.com](http://LegacyOaksHomes.com) For More Information & Immediate Registration

**Exceptional innovations in homes that include:**

Unique Ranch and Cape Cod designs, beautifully set against a magnificent wooded backdrop.  
Open floorplans – 1800 to 2300 square feet of living area • Finely crafted luxury finishes throughout  
• Main floor owners' suites • Hardwood floors • Daylight and walkout homesites • 3-car garages and more

**~ Premium Location ~**

Just north of 12 Mile Road on the east side of Haggerty Road, Legacy Oaks is convenient to  
great shopping, restaurants, parks and major access routes minutes from your door.

**Priced From The High \$200's**

Limited Time Opportunity • [LegacyOaksHomes.com](http://LegacyOaksHomes.com)



Sales Office Located | 41050 Vincenti Court  
Novi, Michigan 48375 | 248.388.1599  
[LegacyOaksHomes.com](http://LegacyOaksHomes.com)



Prices, features, amenities & square footage are approximate and subject to change without notice. Photographs may not be of actual designated home and are intended for representational use only. Oral representations cannot be relied upon as correctly stating representations of the developer. Please see sales consultant for details.

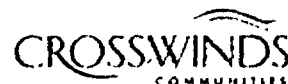

Grand entrance located just North of 12 Mile Road on the East side of Haggerty Road

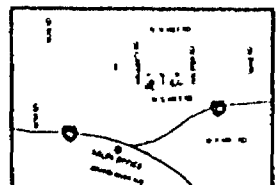

## WHY RENT WHEN YOU CAN CUSTOMIZE YOUR OWN CONDO FOR LESS?

- 1 Bedroom 1 Full Bath for as low as \$556.00 per month\*
- 2 Bedroom 2 Full Baths for as low as \$773.00 per month\*



### FARMINGTON HILLS NEWEST CUSTOM CONDOS

- 1 & 2 bedroom condominium homes
- Serene natural setting
- Outdoor pool and tennis courts
- Fitness center
- Convenient location
- Extraordinary views
- Surrounded by 30 acres of woods
- Priced from \$107,900

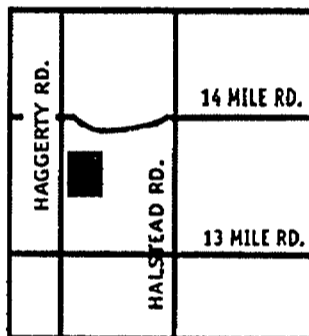

**EVERYTHING IS NEW!**  
 All new *kitchens*; with new cabinets, countertops, appliances; *bathrooms*, with new ceramic tile, vanity, bathtub and toilet; new *carpet and vinyl*; *lighting package* in contemporary brushed nickel; and *custom paint job!*

Sales Center and Decorated Models  
 30545 Crest Forest, Farmington Hills  
 East side of Haggerty (btwn. 13 and 14 Mile Roads)  
 Hours: Daily 11-6 pm  
 248.487.2400 or 866.242.3355 toll-free  
 brgcustomhomes.com



\*Assumes 1% down, excludes association dues and taxes. Total payments for the 1 bedroom starting at \$420/month\* and total payments for the 2 bedrooms starting at \$1,180.00/month\*\* All information subject to change at anytime without notice.

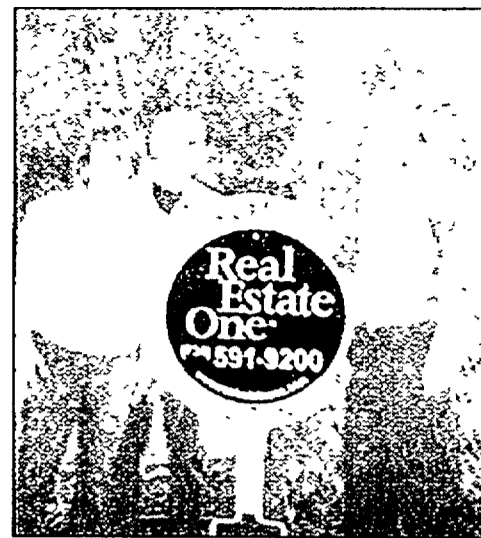

## 'House Hunters'

Last week, Realtor Gary DeGrandchamp of Livonia and parents Sharon and Keith were featured on HGTV's 'House Hunters.' The senior DeGrandchamps' selection of a home on Sherwood in Livonia was revealed during the broadcast, first aired Sept. 7. Sharon DeGrandchamp noted her friendly neighbors and the city's facilities as draws when they moved from Dearborn Heights. Their son is with Real Estate One and handled the home sale.

## REMERICA...is Proud to Announce their Top Selling Agents for the month of August 2006

INTEGRITY REALTORS®

Look to these  
**TOP PROFESSIONALS**  
 for All Your  
 Real Estate Needs.

LIVONIA



Judy Lidsbarski  
 734-525-4200

NORTHVILLE



Keith & Lisa Brandt  
 248-912-9990

## You CAN Have It All...

**Strength • Energy Efficiency • Quality • Value**

**KJ Jovnanian Homes**  
 BUILD ON YOUR LOT

Custom Built Homes with Top Name Brands:  
 Aristokraft, Lennox, Moen, Clopay, Mannington, Andersen Windows and a 30 year basement waterproofing warranty!



**Hartland Sales Center • (810) 632-9520**  
 2121 Melody Place • Hartland, MI 48353

Mon. & Thu. 9 - 7, Tue. & Wed. 9 - 6, Fri. 9 - 5, Sat. 10 - 4 and Sun. Noon - 5 or by appointment

**LOG ON TO KHOVBOYL.COM**

We are pledged to the letter and spirit of U.S. policy for the achievement of equal housing opportunity throughout the Nation. We encourage and support an affirmative advertising and marketing program in which there are no barriers to obtaining housing because of race, color, religion, sex, handicap, familial status or national origin. \*Classic Series only.

Brokers Welcome

# FEATURE HOMES



**BELLEVILLE**  
OE06471292

Simply Irresistible! 4 bedroom, 2 1/2 bath, 2436 sqft home w/ a spectacular finished basement, 3 car garage, family room w/ marble surround fireplace, formal dining rm & many more exquisite features! \$269,900 ID#218-0E  
Call The Drake Team (734) 699-8000  
Keller Williams Realty www.thedraketeam.com

**BELLEVILLE**  
OE06471271

4 bedroom, 2 1/2 bath beauty! Large family room with fireplace. Huge master suite with 3 closets, master bath with 2 person garden tub and marble tile flooring, huge deck and patio with hot tub. \$268,000 ID#256-0E  
Call The Drake Team (734) 699-8000  
Keller Williams Realty www.thedraketeam.com

**BELLEVILLE**  
OE06471299

Build your dream home on one of the large 1+ acre lots! This neighborhood has all utilities underground, gas, electric, cable, telephone & public sewers. It's located in a quiet country setting, but it's just minutes from schools, expressways. \$229,900 - \$66,300. Call me today!  
Call The Drake Team (734) 699-8000  
Keller Williams Realty www.thedraketeam.com

**BRIGHTON**

NOVI is the best time to invest in a piece of the new Brighton sub near Kensington Park w/ prices starting at \$69,900. 8 homes approx. \$350K - \$450K. Custom financing available in area of newly approved shopping mall & more. Please 34-acre lots overlooking acres of commercial. BUY NOW WITH THESE LOW PRICES. BUILD LATER. MUST BE 25% OF THE PLEASANTON COMMERCIAL. All in the same storage. Superior.  
Call Christine Migliore (810) 923-0906  
CHRISTINE MIGLIORE, INC www.brokeronlygroup.com

**HIGHLAND**

Nicely updated 3 BR ranch on treed lot. Living room w/ ventless gas FP and tray ceiling. Large open kitchen and eating area. Updates include windows, dining furnace & CA. Huron Valley Schools. \$143,500. For prompt service seven days a week, call our SELL Phone.  
Call Team Callan SELL Phone: 810-623-7876  
RE/MAX Platinum www.teamcallan.com

**HOWELL**

Very well maintained 3 BD ranch, fin. 2 car gar., family room with brick fireplace, deck. A/C many updates. All sports private lake access. \$169,000.  
Call Joyce Staszak (810) 923-6689  
HERITAGE GMAC REAL ESTATE

**MARION TWP.**

NEW CONSTRUCTION. Immediate Occupancy! 1950 sq ft 2 story w/ 4 BRs & 2 1/2 BA. Oak trim & Direct vent FP w/ ceramic surround. Gorgeous maple cabinets w/ granite in kitchen. In lot. Extended 2-car gar. w/ auto seats & sprayer system included. Close to I-96 freeway, access to Huron Valley Schools. Great neighborhood with top MICHIGAN SCHOOLS! \$249,900.  
Call Theresa Eiguren (810) 599-5612  
MITCH HARRIS BUILDING CO. www.mitchharris.net

**NOVI**  
OPEN SUNDAY SEPT 17 1-4 PM

Custom built in 2004 this 4 bdrm 3.5 bath cape cod sits on 1 acre on quiet cul de sac. Northville schools. 3900 sq. ft. gorgeous home features 2 story foyer & gr. room w/ curved staircase. GORGEOUS! \$697,000  
CENTURY 21 CHALET (734) 432-7600

**REDFORD**

Attractive ranch home with hardwood floors, vinyl windows thru-out and remodeled kitchen. Finished basement with full bath, recreation room, nicely finished laundry room and office or fourth bedroom. Plenty of storage room. Garage has a workshop.  
Call Ron Fron - Cell - (313) 815-6840  
Clark & Fron Realtors - Office - (734) 425-7300

**VAN BUREN**

Stunning spacious home on premium lot. 3 bedrooms, 2 1/2 baths, den & loft. 1st floor laundry, sprinklers, stamped patio with 8 person Jacuzzi. 2453 sq ft. Family room with natural or gas fireplace. 2 car attached garage. Must see! \$263,500.  
Call Claudia Ruloff (248) 752-5680  
Remenca Country Place (734) 961-2900

**WIXOM**  
OE064671122

Fabulous colonial built in 2002. Freshly painted fin. walk out bsmt. two level deck w/ jacuzzi w/ new paver brick patio. 1960 sq ft. master suite w/ walk in closet, extensive hwd & ceramic flooring. \$199,900.  
CENTURY 21 CHALET (734) 432-7600

**YPSILANTI TWP**

Perfect starter home! 3 bedrooms, 1 1/2 baths. Partially finished basement with 1 bath, newer windows, roof, furnace & hot water. 2 car garage across from school & minutes to the expressway. \$194,900. ID#213-0E.  
Call The Drake Team (734) 699-8000  
Keller Williams Realty www.thedraketeam.com

Now accepting reservations for future ads in our Featured Homes page.

Call your local Advertising Representative for more information.

# River Bend

CONDOMINIUMS

The opportunity of a lifetime!



ONLY 4 UNITS LEFT!

Prices starting at **\$289,900**

- INCLUDES • Free finished walkout • 2300 sq feet living area • 3-1/2 baths  
• 2 car garage • Finished deck • Andersen windows • Merillat cabinets  
• Gas fireplace • Scenic park location beautifully landscaped

**BUILDER'S  
CLOSEOUT**

Purchase a new condo and receive any one of the following options that fits your lifestyle....

- Mortgage interest buy down to 5%
- Paid closing costs • Furniture package

Call or stop into Model for more details.

Model located at Northville Road and Edward Hines in Plymouth Township. Open Friday, Saturday and Sunday 1:00 to 6:00 pm. Call Sales Office on weekends for details: 734-254-9077

By appointment during the week. Please contact:

**MONARK REAL ESTATE**

Office: 248-374-1838 Direct: 248-755-2794

Attention Agents: 3% commission + bonus



**CANTON** - Beautiful home on premium site w/ protected woodland view & paver patio. Offers 4 bdrms, 2.5 baths, spacious ktchn w/ island & ceramic flr overlooking fmly rm & lrg yard, dual staircase, gracious master w/ walk-in-closet + more. \$412,500 (D70Mer)

**LIVONIA** - Spectacular 2004 built 3 bedrm, 2.5 bath condo offering 2019 sq ft of luxurious living. 1st floor mstr & bath, upgraded gourmet ktchn w/ cherry cabs, oak hardwood flrs, full bsmt, att'd garage, 1st flr laundry, decorated to perfection! \$279,900 (L69Bro)

**LIVONIA** - Fantastic 4 bedrm, 2.5 bath quad offering newer ktchn w/ bleach oak cabs & Corian counters, new thermal wndws, newer x-tra wide drive & patio overlooking large yard, newer baths w/ ceramic floors, fmly rm w/ frplc + tons more. \$229,900 (L16Fit)

**DEARBORN** - Wow & Wow! This house has it all! Offers 4 bdrms, 1st flr master, newer ktchn w/ hickory cabs, ceramic counters & limestone floor, new baths, library w/ lg wndws, cedar lined closets, fin'd bsmt w/ lav + tons more! \$229,900 (L25Cam)

For information on every home for sale in S.E. Michigan, go to:

[www.qualitygmac.com](http://www.qualitygmac.com)

**Quality REAL ESTATE**

(734) 462-3000

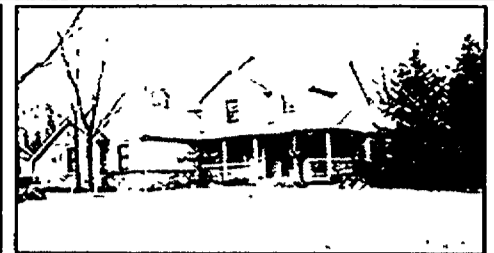

**BRIGHTON** - Beautiful custom built 3 bedrm, 2.5 bath colonial offering huge gourmet ktchn w/ Jennair island, endless cabs & wood flrs, large sunken great rm w/ stunning frplc & custom built-ins, wooded lot, 3 car garage + more. \$327,000 (D35Lau)

**NOVI** - Charming, spacious well-kept 4 bedrm ranch! Roomy country ktchn w/ island & wood-burning stove, lrg master & bath, fin'd basement w/ home office & new above-grnd pool w/ deck. Near award-winning Novi school + home warranty! \$269,900 (L61Qui)

**SOUTHFIELD** - Immediate occupancy for this 3 bedrm, 2 full bath ranch offering open floor plan, 2 car garage, master with full bath, deck off bedrm, freshly painted and new carpet. Home priced under market value! \$119,900 (L50Mil)

**LIVONIA** - Premium Lot in Deer Creek! Beautiful 4 bedrm, 2.5 bath colonial w/ stunning circular stairway. Large fmly rm w/ frplc, full length wndws & French drs to custom decks from each side. Private park-like yard. Home is like new! \$379,900 (L51Way)



OF09470617

## MICHIGAN GROUP REALTORS

SERVING ALL OF SOUTHEAST MICHIGAN



**OPEN 9/17/06 12 to 3 PM**  
**318 PINEKNOLL COURT • BRIGHTON**  
Grand River East to Rickett Rd, SE to Sisu Knoll to Pineknoll. End unit on cul-de-sac, overlooks woods cathedral ceilings, gas fireplace, 2 decks, finished w/o with additional 700 sf, bdrm & bath Wheelchair accessible  
MLS #26040360 \$199,850  
Nick Natoli (810) 844-2278



**BRIGHTON SCHOOLS**  
Spectacular 2,858 SF, 4 BR, 2.5 BA, 1.5 story home on 1 acre lot in highly sought after Brighton location! Feat: 2 story foyer & GR, 1st flr mstr suite, mstr bath w/6' jacuzzi, library off foyer, 3 car garage!  
MLS #26088256 \$384,900  
Randy Meek (810) 844-2220



**BRIGHTON SCHOOLS**  
Exclusive Lake Villa Condo - Brighton Spacious 2,080 sq ft., 2 BD, 2.5 BA with lake access, clubhouse, tennis & more. 42" Cherry cabinetry.  
MLS #26068124 \$279,900  
Yvonne Perry (810) 217-2014



**BYRON SCHOOLS**  
Best of both worlds! Surely well built, well planned '03 ranch. Better than new! Rests body on one of the pre-est lots in county. Large GR boasts custom maple flrs, lowering ceilings, FP w/remote & more. Huge mstr bath w/soaking tub & sep shower. Kitchen w granite, ceramic stainless appliances. Doorwall to deck overlooks natural forest. Full w/o lower level w extra room, home theatre. Home warranty. Fast occupancy!  
MLS #26111725 \$218,900  
Michael Heiler (517) 861-1766 • www.mikemovesmichigan.com



**HARTLAND SCHOOLS**  
Absolutely gorgeous home w/ upgrades galore! 5 BD, 3.5 BA. Gourmet kit w 42" maple cabinets, snack bar & built in appliances. 2 story foyer & a 2 story LR, hrdwd flrs thru-out, gorgeous dual staircase, gas FP w custom mantle, finished bsmt w daylight windows & wet bar & so much more! Easy access to US-23  
MLS #26138755 \$334,900  
Janene Spencer (810) 844-2633



**HARTLAND SCHOOLS**  
Seller relocated - reduced for quick sale! Gorgeous Colonial on 1/4 acre lot feat 4 bedrooms, 3.5 baths, 2 story foyer, hardwood floors that extend into the kitchen nook & half bath. Gourmet kitchen w maple cabinets & center island, part finished daylight basement - much more! Easy access to US-23  
MLS #26139439 \$249,950  
Janene Spencer (810) 844-2633

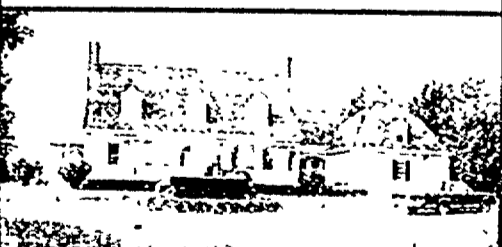

**PINCKNEY SCHOOLS**  
Beautifully landscaped cape cod overlooking private at sports Lake Walboby 18.81 acres. Only 11 other parcels surround the Lk. Existing homes valued at \$1M & up. Great llr for fishing. Located in Golf Comm w Equestrian Center close by. Close to State Land, riding & hiking trails. Fin bsmt incl 1/2 size basketball gym w 22 ceilings, indoor hot tub & bar, horse barn w lg paddocks.  
MLS #24117440 \$1,799,000  
Joseph Dekroub (810) 227-4600

**VOTED 6 YEARS  
IN A ROW!  
LIVINGSTON COUNTY'S**

**#1**

**REAL ESTATE  
COMPANY!**

(810) 227-4600

6870 GRAND RIVER • BRIGHTON

(810) 714-7300

3160 SILVER LAKE RD. • FENTON

(248) 437-5000

22180 PONTIAC TRAIL • SOUTH LYON



SERVING FOWLerville & LIVINGSTON COUNTY SINCE 1946!

**HARMON**  
Real Estate

100 W. Grand River,  
Fowlerville  
517-223-9193

www.harmonrealestate.net  
**OFFICE HOURS**  
M-F 8:30-5:30 Sat. 9:00-4:00  
Evenings & Sun. By Appt.



**INVESTORS \* BUILDERS \* FARMERS \* HORSE LOVERS!**  
These 76 acres are gorgeous and are partly wooded and has high rolling hills. Currently being farmed with over 25 acres of hay and has 3 large barns. Front 20 used for horses and cows also has wildlife galore with large deer, turkeys and pheasants. Small home with many updates. Splits available and seller will consider a Land Contract. Terms negotiable. Fowlerville Schools \$675,000



**YOU MUST SEE TO BELIEVE!** This 3 story unique commercial building is located in the downtown business district of Fowlerville. Loaded with lots of character and charm with over 6000 sq. ft. of total space. The entry floor is currently used as a residence which contains over 3000 sq. ft. alone! Instant income from the 3 apartments, 2 of which are currently rented for \$475 each. The possibilities are endless for the uses of this unique building! \$388,200

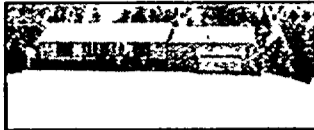

**JUST LISTED!** If privacy and seclusion is what you are looking for then this is it! This setting has it all with woods and a pond and is located only 2 miles from town. This split floor plan ranch home features 3 bedrooms, 2 baths, walkout basement and central air. 11.5 acres, 2.5 car attached garage and a 24x32 pole barn for extra storage and located on a paved road. Fowlerville Schools \$239,900



**LOVELY HOME NEW TO MARKET!** Wonderful, quiet and friendly place to call home and is in walking distance to town. This home has all the perks for the new home buyer but includes all the appliances, is landscaped and decorated nicely so you can move right in without lifting a finger! Immediate possession and seller is offering closing assistance with reasonable offer. Linden Schools \$189,900



**GOOD STARTER IN NEED OF A LITTLE TLC!** This 1.5 story home is located in the Village of Fowlerville and features 4 bedrooms of which 2 are located on the main level. Dining room, large living room and first floor laundry. Within walking distance to town, schools and community parks \$129,900



**STARTER WITH ALL APPLIANCES INCLUDED!** Updated 4 bedroom home in the Village. Gorgeous wide wood trim, built-ins, pillars and floors. Beautiful enclosed porch/sunroom, formal dining room and kitchen with breakfast nook. All appliances included! Full basement and fenced back yard with shed. Fowlerville Schools \$139,900

We have many other homes to choose from.

**COMMERCIAL & VACANT LAND**

**NEW - FOWLerville SCHOOLS...** Several 2+ acre parcels with good conventional perc's. Land Contract Terms available! Prices range from \$46,500 to \$49,900.

**NEW - FOWLerville SCHOOLS...** Wildlife galore! This 15+ acre parcel has approximately 7-8 acres of woods! Private setting with a great perc. Land Contract Terms available \$149,900

**FOWLerville SCHOOLS...** Nice 3 acre parcel located on a corner lot with some woods. Perc & survey complete \$59,900

**WEBBERVILLE SCHOOLS...** Perc and survey complete for this wooded setting that fronts on the Red Cedar River. 2.5 Acres @ \$49,900

**WEBBERVILLE SCHOOLS...** Nice lot close to Village office, library, schools. Land Contract Terms available \$31,900

**FOWLerville SCHOOLS...** Beautiful 3.90 acre walkout site with a great view for \$56,900. Survey and perc complete and all are on paved road

FOR ASSISTANCE AFTER HOURS \*call\* TAMARRA BURNIE @ 517-404-5221  
CONTACT OUR EXPERIENCED AGENTS FOR A "FREE MARKET ANALYSIS"!!!



Top Ten Sales Associates, Regionally, Northern  
Region (19 States)

"Over \$495,000,000 Sold"

**John Goodman**

"The Proven Choice" • Coldwell Banker Schweitzer

www.john-goodman.com

(248) 347-3050 x254 (248) 908-2799 Pager

"Professional Athlete Specialist"

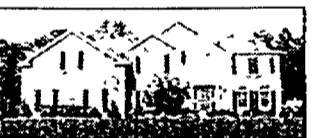

**IMMEDIATE OCCUPANCY! NORTHVILLE HILLS COLONIAL BACKING TO WOODS!**  
Beautiful 2 story foyer with wainscoting and crown molding, cherry stained hardwood floors in foyer, half bath, kitchen, nook and conservatory. 42" cherry cabinets with premium wood package in kitchen with granite counters, 2 story family room with a wall window, dual staircases, study, formal living and dining rooms, master suite with living room, 2 walk in closets and glamor bath, 3.5 car garage and more \$549,000



**CONTEMPORARY NOVI CAPE COD BACKING TO WETWOODLANDS**  
This home features first floor master with tiled ceiling and private deck, 2 story foyer and great room with wall of windows and bridge spanning kitchen with butler's pantry, finished walkout lower level with family room, living room, bath and second fireplace, new roof, 3.5 car garage, deck, paver patio and sidewalks in the subdivision \$550,000

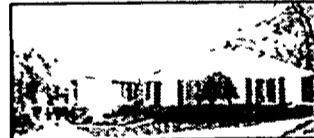

**OPEN SUNDAY 1-4 LAKES OF NORTHVILLE RANCH**  
42520 Roadster Over 3500 sq. ft. of living space! Great room with beautiful birds and floor to ceiling fireplace & recessed lights, remodeled master bath & kitchen stainless steel appliances, finished lower level with huge family room, rec room, 2nd kitchen, studs & full bath, all new windows, front & exterior doors, siding, deck & cabana! \$319,900

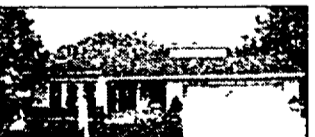

**CUSTOM UPGRADES GALORE IN THIS NOVI COLONIAL!**  
You won't believe your eyes when you see the features of this home like hardwood floors, vaulted ceilings, remodeled baths, remodeled kitchen, extensive crown moldings, new stone elevators, finished basement w/second kitchen, new light fixtures and carpet throughout, fenced backyard and more a must see. \$255,000



**IMPECCABLE COLONIAL IN SOUTH LYON'S TANGLEWOOD**  
Backing to the 1st farm of West Goshute, this home features two story foyer, 10 ft. cellars in living and family rooms, natural fireplace in family room, cherry cabinets in kitchen with nook, master bedroom suite with tray ceiling, two walk in closets and separate shower and tub, hardwood floors, finished lower level with rec room and office w/closet, deck and paver walkway and patio \$185,000



**NEW CONSTRUCTION ON 3/4 ACRE LOT IN MILFORD!**  
Located in prestigious Forest Ridge subdivision with homes up to \$2.2 Million. Gourmet kitchen w/42" cherry Latona cabinets, granite, dining rm w/butler's pantry w/bar, ref, study w/gas fireplace, marble surround, French doors, kitchen, great rm w/10ft ceiling, gas fireplace, master suite w/tray ceiling & glassed bath, granite to be the 5th cherry hardwood floors on 1st floor, 8th or higher ceilings on 1st floor, iron spindles on stairs, Jack & Jill bath, walkout 11 w/pond, 1.5 car garage \$400,000

**TOP 1% NATIONWIDE IN SALES**  
My Success is built on Putting My Customers first  
Service + Dedication = Results

www.hometownlife.com



**NOVI**

Fabulous custom home. Crown moldings, Brazilian walnut flrs, luxurious baths. Gourmand's kitchen w/ Dacor & Mele appls, granite island. Tiered paver patio & walls plus extensive gardens. \$599,900 (26138304BUR) 248-647-6400



**NOVI**

Northville schools. Large open kitchen w/butler's pantry. Dual staircases, 2 story foyer. Master ste w/ jetted tub & shower. Jack & Jill suite. Formal living & dining rms. Finished bsmt w/wet bar & full bath. \$499,000 (26154912ROX) 248-324-3800



**HIGHLAND TWP.**

100 ft of sandy beach frontage on all sports Duck Lake. New addition w/unobstructed views with flr to ceiling windows, vaulted ceiling, hot tub rm and more! Dock & boat hoist stay 3 bdrm, 2 baths. \$399,900 (26133768DAV) 248-647-6400



**BRIGHTON AREA**

2.17 ACRES w/pond! Virtually total update/ upgrade/ addition! Soaring ceilings. Pella windows, huge dream kitchen, dramatic family rm. Ductless AC & eco smart water sys! \$329,500 (26153153WIL) 248-324-3800



**Prudential**  
**Granbrook, REALTORS**

www.prudentialgranbrookrealtors.com • Preview all of our fine listings showcased on Realtor.com

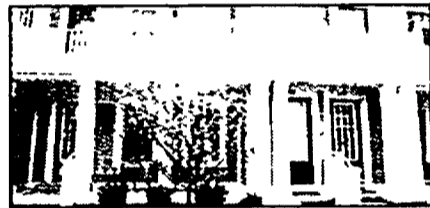

**CANTON**

Fabulous unit, great location, soaring ceilings. Great rm w/FP, gourmet kitchen w/honey maple cabinets, stainless appls, hwd flrs, 2 master stes w/full baths. Bsmt 2-car garage, premium upgrades. \$259,000 (26151783PAT) 248-647-6400



**LIVONIA**

Wonderfully maintained home w/50's flair. Rich wood built ins, hwd flrs, Andersen windows, FP w/Indian River stone hearth. Dining rm opens to spacious 3 season sun rm. Paver patio. Beautifully landscaped. \$199,900 (26147980CRA) 248-626-8700



**DEARBORN**

Updated bungalow w/newer oak kitchen w/custom counters. Newly refinished hwd flrs. Newer baths, furnace, windows, copper plumbing & roof. Fabulous master ste w/WIC & full bath. Newly landscaped. \$179,900 (26151745PAR) 248-626-8700



**LIVONIA**

Super cute 3 bdrm, 1 1/2 bath ranch in Rosedale Gardens. Nicely appointed w/updated tile in kitchen & bath. Attractive finished bsmt w/wet bar & lower level family rm. Flooring has been refinished. \$168,500 (26143090BRO) 248-647-6400



**DEARBORN HEIGHTS**

Adorable 2 bdrm bungalow completely remodeled this year! New roof, windows, carpet, kitchen, bath, siding, paint, plumbing fixtures, flooring you name it. Neutral, gorgeous & immaculate. Priced to sell! \$118,000 (26132007POL) 248-851-4400



**WESTLAND**

Investors/Handyman dream come true! House gutted except for newer bath, 2 bdrms, 1 bath, newer roof, screened porch, 1.5 detached garage w/heater (needs to be connected). Price reflects updates! \$72,500 (26134875SEC) 248-647-6400

**VACANT LAND**

**LYON TWP**

10 Mile Rd "Golden Corridor"! Everything being developed except this previously unavailability jewel! Fronts to 10 Mile Rd, sides to Johns Rd. \$5,950,000 (26059124TEN) 248-324-3800

**MILFORD**

Build your dream home on 23 gorgeous private acres or divide into 8 lots. Survey available. Call for more information \$999,000 (26035962SOU) 248-626-8700

**HIGHLAND TWP**

Private golf community. Bring your own builder. Social membership includes private pool and clubhouse. Great wooded lot with golf course views. \$94,900 (26129817TRO) 248-647-6400

Auburn Hills



**ONE & TWO  
BEDROOM  
CONDOMINIUM  
HOMES**

COME  
SEE OUR  
SNEAK  
PREVIEW  
NEW  
MODELS

From  
**\$95,990**

**FREE  
HIGH-SPEED  
WIRELESS INTERNET**

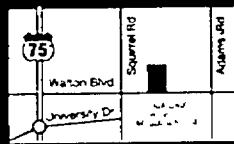

LOCATED ON WALTON ROAD  
JUST EAST OF SHERWOOD ROAD

*The*  
**BOULEVARD**  
C-O-N-D-O-M-I-N-I-U-M  
*of Oakland*

(248) 276-0800



MODELS OPEN 1-6 PM INCLUDING WEEKENDS - CLOSED THURSDAYS

PRESENTED BY



Flagstar  
Real Estate  
314 372 1221

Real Estate Sales &  
Property Management  
(248) 377 2200  
www.flagstar.com

Fenton



From  
**\$79,990**

- PRIVATE ENTRY
- IN-UNIT WASHER/DRYER
- PRIVATE PATIO/BALCONY

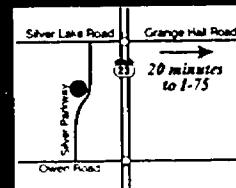

LOCATED ON SILVER PASSWAY  
WEST OF SILVER LAKE ROAD

*Fairfield*  
CONDOMINIUM

(810) 629-5082

**BRIEFS**

FROM PAGE 6

"Budget Management and Cost Control" 8 a.m. to noon Tuesday, Sept. 19, at BIA headquarters, 30375 Northwestern Highway, Suite 100 in Farmington Hills. Attendees will learn the importance of the superintendent's role regarding profitability as well as how to control job costs. Fee is \$150. To register, call (248) 862-1033.

■ Remodelers Council Shoot Out 10 a.m. to 5 p.m. Tuesday, Sept. 26, at Detroit Gun Club, 2775 Oakley Park Road in Walled Lake. Fees include lunch, 50 rounds of skeet or trap, 100 rounds of sporting clays and six boxes of shells, \$115 for BIA and Apartment Association of Michigan members, guests and nonmembers. Station sponsorships are available for \$150. To register, call (248) 862-1008.

■ Sales & Marketing Council will present a "High Heels, Starbucks and Carpool: Selling & Marketing to Multi-Tasking Women" seminar 8:30-10:30 a.m.

Wednesday, Sept. 27, at Michigan Design Center, 1700 Stutz Drive in Troy. Meredith Oliver of Meredith Communications and Melinda Brody of Melinda Brody and Company will discuss the importance of women as a target market, what women want from a new home consultant and how to sell to women online. Fee is \$59 for SMC members and \$79 for BIA or Apartment Association of Michigan members. To register, call (248) 862-1033.

■ Apartment Association of Michigan's Property Management Council will sponsor an "Extreme Makeover Marketing" seminar 9 a.m. to noon Wednesday, Sept. 27, at AAM headquarters, 30375 Northwestern Highway, Suite 100 in Farmington Hills. Attendees will learn about technology, curb appeal, competition, traffic analysis, closing and retention. Fee is \$69 for PMC members, \$79 for AAM or BIA members, \$99 for guests. To register, call (248) 862-1004.

www.robertcuffe.com

**Robert & Lisa Cuffe, GRI, ABR**

"The Team with Integrity" Remerica Integrity Realtors

Thinking of Buying or Selling your Home or Condo?

Call Robert or Lisa TODAY!

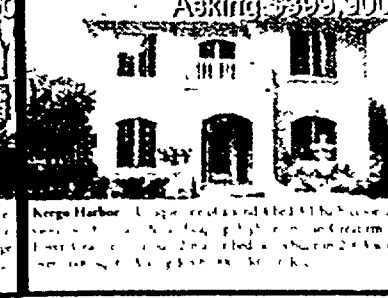
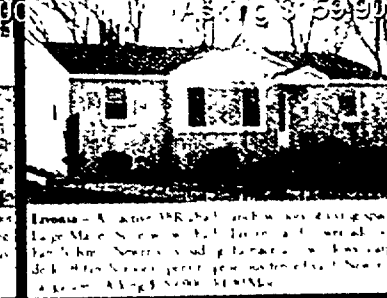
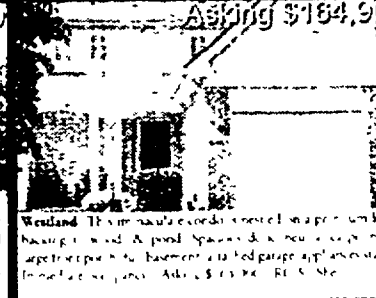
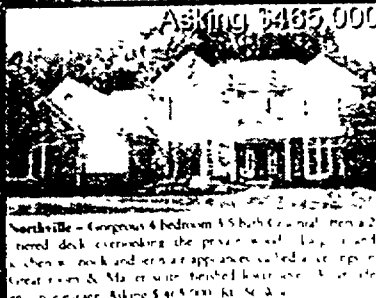
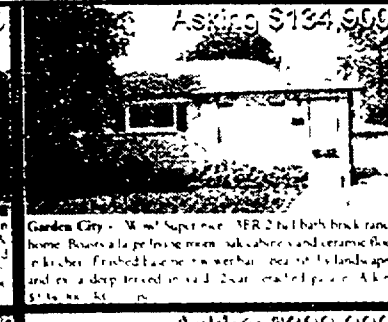
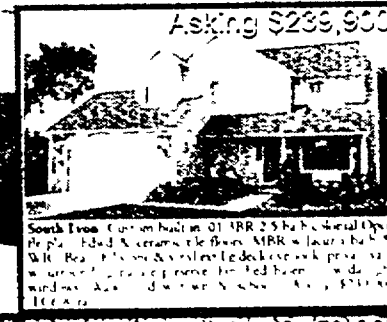
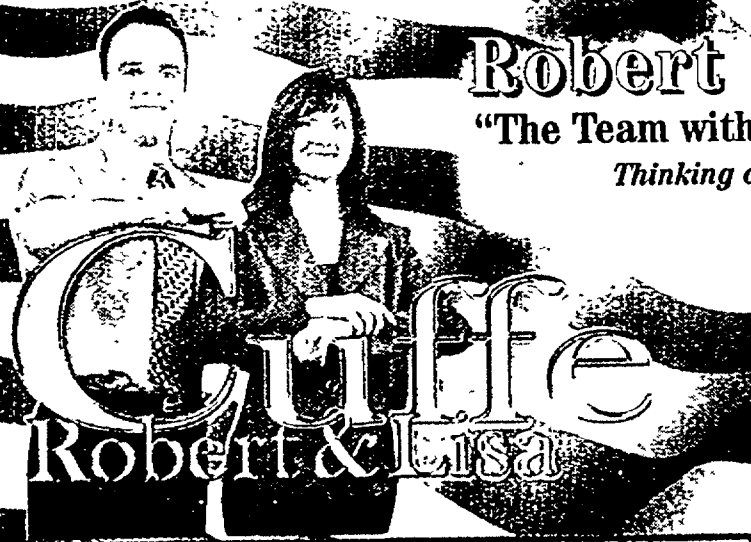

**REMERICA**  
INTEGRITY REALTORS

**Livonia** 16172 Middlebelt  
**Northville** 41000 7 Mile, Suite 105  
Two Locations for your Convenience  
Robert cell: 734.637.7000 Lisa cell: 734.637.7100  
Online: www.robertcuffe.com

EARN EXTRA \$\$\$ Our Booming Real Estate Offices in Livonia & Northville are seeking Outgoing Salespeople! Training Available. Call Robert today!

NEW HOMES FROM THE \$180'S

**ORCHARD PARK**

Coming Soon to Howell  
Community Clubhouse • Pool • Soccer Field

To Join The Abbey Homes VIP Priority Purchaser List, visit  
[www.OrchardParkVIP.com](http://www.OrchardParkVIP.com)  
Or call 517-540-0407

**ABBEY HOMES**

Where the Living is Easy



www.hometownlife.com



# Buying Investment Property...

## Free Seminar

- Buying a Foreclosure and what to look for
- Financing Investment Properties
- The benefits of a 'Lease/Option to Buy'
- 'Fix and flip' vs. rental properties

**Where:**  
Metropolitan Title  
134 North First St.  
Brighton, MI 48116

**When:**  
Tuesday, September 26  
7:00 - 8:00 p.m.

*Call to register...  
seating is limited!*

**Diane Adamick**  
Approved Mortgages  
734-455-2219, x-217

**Real Estate One**

Deidre Bondrean, Realtor

Norm Werner, Realtor

## The Milford Team

### Our Highland Listings



2000+ Sq. Ft., 4 bd,  
2 full bath &  
2 half, on 2.7 acres,  
updates galore,  
granite kitchen,  
huge deck. 3-car  
garage. \$309,000

4 bedroom,  
2.5 bath,  
5 acres,  
1910 Sq. Ft.,  
bring your  
horses. \$410,000



4232 Stone Barn



4 bd, 2.5 ba in  
2750 Sq. Ft.  
home with part  
fin. bsmnt, deck  
and patio in  
great sub.  
\$300,000

Nature lovers  
delight - on  
Murray Lake. 3 bd,  
2.5 ba, 2366 sq.  
ft., fin bsmnt, GR,  
sunroom, deck.  
\$399,900



4787 Mallards Landing

277 Briarwood

While you're in town for the 2006 Milford Home Tour, go see these local houses.



680 Milford Glen

**Open Sunday**  
Last new-build in  
Milford Glen - 3 bd,  
2.5 ba, 2100 Sq. Ft.,  
WO bsmnt, modern  
kitchen. \$252,900

Casual elegance in  
2500 S. Ft. 3 bd, 3  
ba home. Cherry  
kitchen, MBR w/WIC  
and shower & tub  
bath \$324,900



820 Milford Glen Circle



423 East Street

Milford historic home  
just 3 blocks from  
downtown 4 bd, 2.5  
ba, screened back  
porch, oversized Yard  
\$275,000

Grand old Victorian just  
2 blocks from down-  
town Milford 3 bd, 2.5  
ba, totally updated-  
granite kitchen, great  
woodwork \$420,000



222 Center Street



124 2nd Street

Just south of the  
downtown area, 3 bd,  
2.5 ba, open floor  
plan, new Trex deck,  
private backyard -  
\$224,900

Just south of the  
Village, 4 bd, 3.5 ba,  
sunroom, in-ground  
pool, totally modern  
& move-in ready  
Backs to Kensington  
Park \$265,000



1971 S. Milford Rd.

[www.themilfordteam.com](http://www.themilfordteam.com)

Deidre Cell: 248-240-7397 Norm Cell: 248-763-2497

560 N. Milford Road • Milford, MI 48381

## NEW PRICING! UPDATED PLANS! CANTON'S BEST VALUE!



VILLA HOMES FROM THE \$220'S  
1,425-2,100 SQUARE FEET



MANOR HOMES FROM THE \$150'S  
1,360-1,470 SQUARE FEET

### TEN YEAR WARRANTY NOW INCLUDES:

- One-story or first-floor master suite with first-floor den
- Full basement
- Two-car garage (per plan)
- Minutes from I-275, I-94 and I-96
- Acclaimed Plymouth-Canton schools
- Superb location—minutes from Metro Airport, fabulous dining, shopping and entertainment venues
- Two to four bedrooms
- Preserved wetlands, natural areas & private park-like area

**GREAT INCENTIVES!  
SAVE UP TO  
\$25,000!**

**THE HAMPTONS**  
CONDOMINIUMS

**NEUMANN HOMES**  
VALUE. CHOICE. TRUST

Welcome Center  
open daily from  
10:00am - 6:00pm  
**734.981.7740**

[www.neumannhomes.com](http://www.neumannhomes.com)

ENVIRONMENTS FOR *Living*

Brokers Welcome

The Hamptons is located off Cherry Hill Rd., east of Sheldon Rd. in Canton

**COLDWELL BANKER**  
BRIGHTON TOWN & COUNTRY  
REAL ESTATE



Everyone's Moving to Livingston County -  
The Fastest Growing County In Michigan!

## Coldwell Banker Brighton Town & Country Real Estate



**HOWELL CONDO \$137,500.00**  
MLS#26152596 - 2 BR, 2 baths  
1377 sq ft., Beautiful End unit!



**BRIGHTON TWP. \$263,900.00**  
MLS#26156856 - Up north lifestyle in  
Brighton! 1518 sq ft. LAKEFRONT!



**HOWELL \$369,900.00**  
MLS#26155378 - Perfect blend of  
old & new. 3 bedrooms



**OAK POINTE \$497,600.00**  
MLS#26153731 - Country Club &  
Golf Community 4 BR, 3 baths

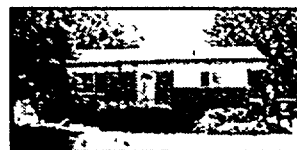

**WESTLAND \$138,300.00**  
MLS#26130170 - Immaculate, updated,  
finished basement. 3 BR, 2 Baths



**HOWELL \$399,900.00**  
MLS#26147644 - 3670 sq ft  
5 ACRES 4 BR, 4 baths



**HOWELL \$268,000.00**  
MLS#26140825 - Beautiful, like new Brownstown.  
2250 sq ft CONDO 3 BR, 2.5 BAs



**HARTLAND \$499,900.00**  
MLS#26115364 - 20 ACRES,  
Custom Log Home, 3 BR, 3 baths



**HOWELL \$235,000.00**  
MLS#26123126 - Open 3 BR  
Ranch! 1+ Acres, 1406 sq. ft.

That's why you need an area specialist.

**810.227.1111**

102 E. Grand River - Brighton • [www.coldwellbankerbrighton.com](http://www.coldwellbankerbrighton.com)

# Free speech case has far-reaching meaning

**Q.** I've heard of a recent New Jersey case that upheld certain free speech protections applied to a community association. Do you have any information?

**A.** Yes. A recent case that is on appeal to the State Supreme Court, a New Jersey Appeal Court ruled that the state's constitutional provision protecting free speech applied to community associations even though they are private organizations. The court reasoned that members don't

waive their rights when they agree to abide by the association's governing documents and much of the court's reasoning was based on the idea that although associations are not governments, they act enough like governments to warrant having to respect the same free speech rights as governments do. For example, the court reasoned that if a community association board expresses an opinion in the community newsletter, it must give opponents to that opinion

equal access to the newsletter to express their opinion. This is a far-reaching decision which may have a tremendous impact on community associations.

**Q.** What is your opinion regarding buying a residential condo in a mixed use development with retail?

**A.** It all depends upon the construction of the condominium and the quality of the condominium documents prepared by the developer's attorney. It can be a very rewarding experience or it can be



Robert Meisner

a nightmare depending upon the efforts that are being undertaken by the developer to insure that the retail does not interfere with the useful enjoyment of the condominium premises in the residential structures. There should be appropriate allocation of expenses and clear definitions of who will have control of the

condo project between the retail and the residential. I have seen situations where developers have been sloppy in regard to the documents which they have created and the tenants to which they have rented space thereby causing problems for the residents of the residential area. Look into these various issues with a knowledgeable condo lawyer and perhaps an engineering consultant. Robert M. Meisner is a lawyer and the author of *Condominium Operation: Getting Started & Staying on the Right Track*, second edition.



## ABBEY HOMES IS KICKING OFF A NEW COMMUNITY!

### ORCHARD PARK Brand New Community in Howell

Townhomes from the \$180s • Single-Family homes from the low \$200s

- Located on Latson Road, just south of M-59 (Highland Road)
- Close proximity to all the great shopping, restaurants and entertainment of Howell and Brighton
- Low-maintenance homes with 2-car garages
- Community clubhouse with pool, soccer field, nature areas and much more!



**ABBEY HOMES**

*Where the Living is Easy*

Visit [OrchardParkVIP.com](http://OrchardParkVIP.com)  
To Become a Priority Purchaser!

or call 517-540-0407

#### THE OBSERVER & ECCENTRIC MORTGAGE MONITOR

		30 Yr.	Pts	15 Yr.	Pts	Other
1st Choice Mortgage Lending	(734) 459-0782	6	0	5.625	0	J/A
A Best Financial Corp.	(800) 839-8918	5.625	1.5	5.25	1.375	J/A
A Perfect Mortgage Co.	(248) 203-7726	6	0	5.625	0	J/A
AAXA Discount Mortgage	(877) 728-3569	6	0	5.625	0.25	J/A
AFI Financial	(877) 234-0600	5.75	1	5.375	1	J/A
American Home Mortgage	(877) 478-7289	5.875	2	5.5	2	J/A/V/F
Ameriplus Mortgage Corp.	(248) 740-2323	5.99	0.25	5.75	0	J/A
Brighton Commerce Bank	(810) 220-8646	6.25	0.5	6	0.5	J/A
Brink's Goldstar Mortgage	(800) 785-4755	5.625	1.875	5.25	1.625	J/A/V/F
Charter One Bank	(800) 342-5336	6.5	0	6.125	0	J/A/V/F
Client Services by Golden Rule	(800) 569-5805	5.75	1.125	5.5	0.75	J/A/V/F
Co-op Services Credit Union	(734) 466-6113	6.375	1	6	1	J
Credit Union One	(800) 544-5567	6.5	0	6.125	0	J/A
Dearborn Federal Savings Bank	(313) 565-3100	6.375	0	6	0	A
DFCU Financial	(800) 739-2770	6.125	2	5.625	2	J/A
Downriver Community FCU	(313) 386-2200	6.75	0	6.35	0	J/A
Earth Mortgage	(877) 327-8450	6.125	0	5.75	0	J/A/V/F
Fifth Third Bank	(800) 792-8830	6.375	0.375	6.125	0	J/V/F
First Alliance Mortgage Co.	(800) 292-7357	6.25	0	5.875	0	J/A/V/F
First International Mortgage	(248) 540-1065	6.125	0	5.875	0	J/A
GMAC Mortgage Corp.	(800) 888-4622	6	2	5.625	2	J/A/V/F
Golden Rule Mortgage	(800) 991-9922	5.625	1.75	5.375	1.5	J/A/V/F
Group One Mortgage	(734) 953-4000	6.25	0	6.125	0	J/A/V/F
LaSalle Bank Mid-west	(800) 466-3800	6	2	5.75	2	J/A/V/F
Mainstreet Mortgage	(800) 900-1313	6.125	0	5.875	0	J/A/V/F
Manufacturers	(586) 777-1000	6	0.625	5.625	1	J/A
Michigan Schools & Gov. CU	(586) 263-8800	6.25	0	6	0	J/A
Mortgages by Golden Rule	(800) 991-9922	6	0.125	5.75	0.375	J/A/V/F
National City Bank	(586) 825-0825	5.875	2	5.5	2	J/A
Northlawn Financial	(248) 988-8488	6	0	5.625	0	J/A/V/F
Pathway Financial LLC	(800) 726-2274	6	0	5.625	0	J/A/F
Premiere Mortgage Funding	(800) 684-7880	6	0	5.625	0	J/A
Shore Mortgage	(800) 678-6663	5.625	3	5.125	3	J/A/V/F
United Mortgage Group	(586) 286-9500	6	0	5.625	0	J/A
York Financial Inc.	(888) 839-9675	6.125	0	5.875	0	J/A

Above information available as of 9/8/06 and subject to change at anytime. Rates are based on a \$200,000 loan with 20% down. Jumbo rates, specific payment calculations & most current rates available Fridays after 2:00 P.M. at [www.rmcreport.com](http://www.rmcreport.com). Key to "Other" Column - J = Jumbo, A = Arms, V = VA, F = FHA & NR = Not Reported. All Lenders are Equal Opportunity Lenders.

© Copyright 2006 Residential Mortgage Consultants, Inc. All Rights Reserved



# ONE WEB SITE: ALL THE HOMES

## RealEstateOne.com

### Over 30,000 Properties



© Real Estate One, Inc., 2006

 <b>\$209,900 - New Hudson</b> 30975 Asbury Hill "Grand Opening" Saturday 12-6 248-437-3800	 <b>\$179,900 - South Lyon</b> Upscale living in this 3 BR end unit 248-437-3800	 <b>\$274,900 - Lyon Twp.</b> Brand new 3 BR colonial! 248-437-3800	 <b>\$550,000 - South Lyon</b> Ranch w/8+ Acres! 248-437-3800	 <b>\$268,000 - Green Oak</b> Updated Ranch, fieldstone fireplace! 248-437-3800	 <b>\$164,900 - Howell</b> Charming 2 BR townhouse! 248-437-3800
 <b>\$408,000 - Northville</b> Impeccably maintained 248-348-6430/349-6200	 <b>\$440,000 - Livonia</b> Home sweet home 248-348-6430/349-6200	 <b>\$173,900 - Northville</b> Nicely updated Condo 248-348-6430/349-6200	 <b>\$234,000 - Novi</b> 4 BR Colonial 248-348-6430/349-6200	 <b>\$129,900 - Walled Lake</b> Cozy Condo/Priv entry 248-348-6430/349-6200	 <b>\$379,900 - Novi</b> Lg open fir plan 248-348-6430/349-6200
 <b>\$329,900 - Farmington Hills</b> 4 BR 2.5 BA Col 248-348-6430/349-6200	 <b>\$250,000 - Novi</b> Updated 4 BR home 248-348-6430/349-6200	 <b>\$299,900 - Commerce Twp.</b> Custom built home 248-348-6430/349-6200	 <b>\$400,000 - Northville</b> Custom 3 BR brnck Ranch 248-348-6430/349-6200	 <b>\$169,900 - Commerce</b> Completely updated Ranch 248-349-6200/348-6430	 <b>\$340,000 - Novi</b> 2600 sqft 4 BR home 248-349-6200/348-6430
 <b>\$250,000 - Highland</b> First floor master & laundry 248-684-1065	 <b>\$1,300 - Waterford</b> 3 season sun room. 248-684-1065	 <b>\$474,900 - Highland</b> Lakefront on 2.2 acres 248-684-1065	 <b>\$300,000 - Highland</b> Fireplace in FR 248-684-1065	 <b>\$244,900 - Milford</b> Heat recovery ventilation system 248-684-1065	 <b>\$194,500 - White Lake</b> Beautiful large lot 248-684-1065

\$59,900 - South Lyon 61265 Heritage Open Sunday 1-4 248-437-3800 26156650	\$489,900 - Salem Log home on 5 private acres! 248-437-3800 26186565	\$214,900 - Ann Arbor Charming well kept ranch! 248-437-3800 26186680	\$139,900 - Novi 2 BR 2.5 BA Condo 248-348-6430/349-6200 26156648	\$169,000 - Brighton Twp 7+ splittable acres 248-348-6430/349-6200 26186021	\$489,900 - Hartland Beautiful kit w/ bkft rm. 248-684-1065 26093304	\$324,900 - Milford Kit w/ xl cabs 248-684-1065 26136382
\$69,900 - South Lyon 61203 Heritage Open Sunday 1-4 248-437-3800 26143552	\$394,900 - Northfield Twp Updated colonial on 10 Acres! 248-437-3800 26113479	\$169,900 - Ypsilanti Well maintained ranch w/cathedral ceilings 248-437-3800 26077403	\$294,500 - Farmington Hills Up north feeling 248-348-6430/349-6200 26154795	\$169,900 - Southfield Cozy 3 BR Ranch 248-348-6430/349-6200 26096847	\$109,000 - Highland Lot in South Bay Shores 248-684-1065 26147754	\$550,000 - Milford 21 wooded W O sites 248-684-1065 26135808
\$68,900 - South Lyon 25234 Franklin Terrace Open Sunday 1-4 248-437-3800 26138220	\$289,900 - Green Oak Well maintained home w/guest suite! 248-437-3800 26128161	\$249,900 - Novi Comfortable & spacious 248-348-6430/349-6200 26094695	\$215,000 - Walled Lake Spacious 3 BR Ranch 248-348-6430/349-6200 26152307	\$292,500 - Novi Special touches T/O 248-348-6430/349-6200 26136612	\$280,000 - Milford 5 gorgeous acres 248-684-1065 26147800	\$545,000 - Highland Marble fireplace 248-684-1065 2608114
\$82,200 - South Lyon 25134 Jefferson Ct Open Sunday 1-4 248-437-3800 26085532	\$125,000 - Salem Beautiful 2 Acre building site! 248-437-3800 26127677	\$339,900 - Huntington Woods Beautiful parklike setting 248-348-6430/349-6200 26087848	\$269,000 - Livonia Wonderful 4 BR home 248-348-6430/349-6200 26134251	\$359,900 - Plymouth 4 BR on treed corner 248-349-6200/348-6430 26136542	\$325,000 - Commerce Finished basement 248-684-1065 26071175	\$154,900 - Milford Hilltop walkout site 248-684-1065 26137110
\$274,900 - Northfield Twp 5+ Acres, private road, 2 st. pole barn 248-437-3800 26118837	\$169,900 - South Lyon Luxury condo downtown! 248-437-3800 26024873	\$579,900 - Wolverine Lake Custom 4 BR Lk home 248-348-6430/349-6200 26119510	\$434,900 - Brighton Golfers dream home 248-348-6430/349-6200 26033989	\$324,900 - Hartland Mstr ste w/ whirlpool. 248-684-1065 26019826	\$369,000 - White Lake Finished bonus room 248-684-1065 26152469	\$329,900 - Hartland First floor master 248-684-1065 26019834
\$240,000 - New Hudson Beautiful brnck ranch w/updated kitchen! 248-437-3800 26129409	\$320,000 - Green Oak Reduced!! Immaculate colonial!! 248-437-3800 26127401	\$126,900 - Redford Twp. Beautiful 3 BR Brngh 248-348-6430/349-6200 26156694	\$319,000 - Farmington Hills Spacious 3 BR Ranch 248-348-6430/349-6200 26040026	\$279,900 - Hartland 4 bed, 2.5 bath home 248-684-1065 26019836	\$550,000 - Milford The Crossings of Milford! 248-684-1065 26039677	\$304,900 - Hartland GR w/ cath cell & fp 248-684-1065 26019832

Milford (248) 684-1065 • Northville (248) 349-6200 • Novi (248) 348-6430 • South Lyon (248) 437-3800



“Last MONTH the Real Estate One company participated in the sale of 1,158 homes. Far more than any other real estate company in MICHIGAN.”  
We're selling homes; we can sell yours.  
Call your nearest Real Estate One office.



— Dan Elsea, President, Brokerage Services

To view these current listings and more, visit us online at RealEstateOne.com

ADDRESS	DESCRIPTION	PRICE	PHONE	WEB ADDRESS
<b>BRIGHTON</b>				
4608 Huntington	3BR/2.1BA/2car/condo	\$335,000	248-348-6430	realestateone.com/26067098
<b>CANTON</b>				
7992 Brampton Dr.	4BR/2.1BA/3car/custom	\$472,500	734-455-7000	realestateone.com/26132533
7422 Oakmont	4BR/2.1BA/3car/2deck	\$459,900	734-455-7000	realestateone.com/26112390
45484 Augusta Dr.	4BR/2.1BA/3car/finwp	\$405,900	734-455-7000	realestateone.com/26075150
674 Brookmill	4BR/2BA/3car/finwp	\$400,000	734-455-7000	realestateone.com/26091521
3540 Napier	4BR/2BA/2car/fran	\$389,900	734-591-9200	realestateone.com/26060051
1516 Hereford	4BR/2.1BA/2car/col	\$379,900	734-455-7000	realestateone.com/26119790
1710 Stonebridge Way	4BR/2.1BA/2car/hardw	\$375,000	734-455-7000	realestateone.com/26069995
2136 Stanton	4BR/2.1BA/2car/finwp	\$370,000	734-455-7000	realestateone.com/26093914
45954 Larchmont Dr.	4BR/2.2BA/2car/col	\$362,000	734-455-7000	realestateone.com/26142908
47643 Ashford Dr. S	4BR/3.1BA/2car/finwp	\$354,900	734-455-7000	realestateone.com/26061332
47441 Fox Run Dr.	4BR/2.1BA/2car/finwp	\$342,500	734-455-7000	realestateone.com/26143163
2411 Woodgreen	4BR/2.1BA/2car/finwp	\$339,900	734-455-7000	realestateone.com/26030158
789 Pheasant Woods Dr.	4BR/2.1BA/2car/finwp	\$315,000	734-455-7000	realestateone.com/26112452
6820 Foxcreek Dr.	4BR/2.1BA/3car/finwp	\$309,900	734-455-7000	realestateone.com/26041394
47597 Vistas Circle	4BR/2.1BA/2car/finwp	\$305,000	734-455-7000	realestateone.com/26031981
7021 Camelot	4BR/2.1BA/2car/col	\$282,654	734-455-7000	realestateone.com/26148166
45752 Spinning Wheel Dr.	4BR/2.1BA/2car/pool	\$275,000	734-455-7000	realestateone.com/26106407
46425 Kilnsey	4BR/2.1BA/2car/condo	\$274,900	734-455-7000	realestateone.com/26115753
41052 Westfield Circle	3BR/2.1BA/2car/col	\$274,900	734-455-7000	realestateone.com/26142109
1098 Paddington	3BR/2.1BA/2car/hp/dtd	\$259,900	734-455-7000	realestateone.com/26105541
44321 Dartmouth	4BR/2.1BA/2car/finwp	\$257,900	734-455-7000	realestateone.com/26094851
6146 New England Lane	4BR/2.1BA/2car/w/fin	\$235,900	734-455-7000	realestateone.com/25171867
43544 Fleetwood Ct.	3BR/2.1BA/2car/col	\$230,000	248-348-6430	realestateone.com/26069040
2467 Amber	3BR/2.1BA/2car/col	\$229,900	734-591-9200	realestateone.com/26143095
2277 Brookhaven	3BR/2.1BA/2car/col	\$229,900	734-455-7000	realestateone.com/26113947
729 Redfield Ct.	3BR/2.1BA/2car/fran	\$225,000	734-455-7000	realestateone.com/26138819
845 Westfield Ct.	3BR/2BA/2car/pool	\$224,900	734-455-7000	realestateone.com/26125812
1957 Century Ct.	4BR/2BA/2car/hp/dtd	\$214,900	734-455-7000	realestateone.com/26149059
45281 Horseshoe Circle	2BR/2.5BA/2car/lead	\$204,900	734-591-9200	realestateone.com/26154147
646 Cherry Orchard	3BR/2.1BA/2car/finwp	\$204,000	734-455-7000	realestateone.com/26079082
41144 Ardmore	3BR/1.1BA/2car/patio	\$200,000	734-455-7000	realestateone.com/26065567
1900 Hawks West Ct.	3BR/2.1BA/2car/condo	\$198,000	734-455-7000	realestateone.com/26132556
6687 Devonshire	3BR/1.1BA/2car/finwp	\$189,900	734-455-7000	realestateone.com/26123626
41535 Wayside	3BR/1.1BA/2car/col	\$189,900	734-591-9200	realestateone.com/26044255
286 Constitution	2BR/2.1BA/1car/condo	\$185,000	734-455-7000	realestateone.com/26023617
1953 Lone Wolf	2BR/2.1BA/2car/condo	\$181,900	734-455-7000	realestateone.com/26132551
4093 Hunters Circle E	2BR/1.1BA/1car/condo	\$149,900	734-455-7000	realestateone.com/26112482
4687 Hunters Circle	2BR/1BA/1car/condo	\$135,000	734-455-7000	realestateone.com/26030994
43479 Arbor Way W	2BR/1BA/1car/condo	\$125,000	734-455-7000	realestateone.com/26111039
6921 Harvard Lane	2BR/1.1BA/1car/condo	\$102,500	734-455-7000	realestateone.com/26132075
<b>COMMERCE</b>				
8123 Farrant	5BR/4.2BA/3car/fran	\$1,800,000	248-644-4700	realestateone.com/26105479
674 Eldersberry Ct.	4BR/3.5BA/3car/col	\$675,000	248-348-6430	realestateone.com/26065933
4659 Darien	4BR/3.1BA/3car/fran	\$440,000	248-363-8300	realestateone.com/26034700
4328 Benstein	4BR/2.1BA/2car/fran	\$369,789	248-363-8300	realestateone.com/26153475
3010 Viking	3BR/2.1BA/2car/col	\$349,900	248-363-8300	realestateone.com/26153158
3952 Dun Rovia Ct.	4BR/2.5BA/2car/hwy	\$330,000	248-363-8300	realestateone.com/26133635
4013 Dan Raven	3BR/2.1BA/2car/finwp	\$300,000	248-363-8300	realestateone.com/26105652
4600 Kara Ct.	4BR/2BA/2car/fran	\$289,900	248-644-4700	realestateone.com/26148831
196 Annon	2BR/2BA/1car/hake	\$267,900	248-363-8300	realestateone.com/26013213
8088 Farrant Street	3BR/1.1BA/1car/fran	\$174,900	248-684-1065	realestateone.com/26129277
717 Farr	2BR/1BA/1car/fran	\$114,900	248-363-8300	realestateone.com/26137061
<b>COMMERCE TWP</b>				
1441 Lee Wood Ridge	3BR/2.1BA/1car/1/2 DR	\$299,900	248-348-6430	realestateone.com/26049684
6205 Jasmine	3BR/2BA/2car/condo	\$219,000	248-348-6430	realestateone.com/26089900
<b>DEARBORN</b>				
22231 Watsonia	3BR/1.1BA/1car/fran	\$222,000	734-591-9200	realestateone.com/26142658
2025 N. Franklin	4BR/2.1BA/3car/patio	\$194,900	248-348-6430	realestateone.com/26015646
24638 Calvin	3BR/1BA/1car/hghw	\$129,900	734-326-2000	realestateone.com/26129429
<b>DEARBORN HEIGHTS</b>				
8328 Lenore	2BR/1BA/2car/fran	\$169,900	248-851-1900	realestateone.com/26072484
<b>DETROIT</b>				
17300 Salem St.	3BR/1.1BA/2car/fran	\$99,900	734-591-9200	realestateone.com/26126752
28521 Annchester	3BR/1.1BA/1car/col	\$94,975	734-591-9200	realestateone.com/26107431
7525 Dolphin	3BR/1BA/2car/fran	\$85,000	734-591-9200	realestateone.com/26122716
14739 Novara	4BR/1.5BA/1car/porch	\$33,900	248-348-6430	realestateone.com/26144828
12661 Riverview	2BR/1BA/1car/fran	\$29,900	734-591-9200	realestateone.com/26136334
8340 Dexter	BR/3BA/2car/multi	\$19,000	734-591-9200	realestateone.com/26143408
<b>FARMINGTON</b>				
23811 Langora St.	4BR/3.1BA/3car/fran	\$449,900	248-348-6430	realestateone.com/26101620
7998 Lawrence	3BR/2BA/2car/condo	\$199,500	248-348-6430	realestateone.com/26080529
32718 Grand River	2BR/1BA/1car/condo	\$76,500	248-348-6430	realestateone.com/26092632
<b>FARMINGTON HILLS</b>				
28615 Venice Ct.	2BR/2.1BA/2car/condo	\$279,900	248-348-6430	realestateone.com/26140422
25845 Gill Rd.	3BR/2.1BA/2car/hp/dtd	\$269,900	734-455-7000	realestateone.com/26109214
32331 Knollwood	2BR/2BA/2car/condo	\$231,000	248-348-6430	realestateone.com/26076139
21996 Coltingham	3BR/2.1BA/2car/col	\$208,000	248-348-6430	realestateone.com/26068081
31177 Country Club	2BR/2.5BA/1car/condo	\$153,000	248-363-8300	realestateone.com/26113977
31240 Country Way	2BR/2BA/1car/condo	\$144,900	248-348-6430	realestateone.com/26075136

ADDRESS	DESCRIPTION	PRICE	PHONE	WEB ADDRESS
31176 Country Way	2BR/1.1BA/1car/condo	\$135,000	248-363-8300	realestateone.com/26076075
21803 Albion	2BR/1BA/2car/hghw	\$109,000	248-348-6430	realestateone.com/26150818
<b>GARDEN CITY</b>				
30225 Rush	3BR/2BA/2car/fran	\$135,000	734-591-9200	realestateone.com/26149757
421 Brandt St.	2BR/1BA/2car/fran	\$110,000	734-326-2000	realestateone.com/26114513
<b>GROSSE POINTE WOODS</b>				
1528 Brys	3BR/2BA/1car/hghw	\$169,500	734-591-9200	realestateone.com/26000446
<b>HARPER WOODS</b>				
20841 Anika	3BR/1.1BA/1car/fran	\$169,900	734-591-9200	realestateone.com/26138245
<b>IRKSHTER</b>				
25953 S. River Park Drive	3BR/1BA/2car/fran	\$115,000	734-591-9200	realestateone.com/26129428
28623 Cherry Hill	4BR/1BA/2car/hghw	\$114,900	734-326-2000	realestateone.com/26144048
605 Fairwood	3BR/1BA/1car/hghw	\$112,000	734-326-2000	realestateone.com/26144051
<b>LYONIA</b>				
27862 Western Golf	4BR/3.1BA/2car/fran	\$324,900	734-591-9200	realestateone.com/26109723
27653 Western Golf	4BR/2.1BA/2car/col	\$320,000	734-591-9200	realestateone.com/26109648
10218 Laurel	3BR/2.1BA/2car/col	\$299,900	734-591-9200	realestateone.com/26131578
19081 Brentwood	4BR/2.1BA/2car/2-story	\$274,900	248-851-1900	realestateone.com/26054731
16810 Mayfield	3BR/2BA/2car/fran	\$255,000	734-591-9200	realestateone.com/26040689
33956 Sleepy Hollow	3BR/1.1BA/2car/pool	\$249,900	734-591-9200	realestateone.com/26111561
38671 Boycroft	3BR/2.1BA/2car/hd/fin	\$249,900	734-591-9200	realestateone.com/26116604
28641 Bayberry Park	3BR/2BA/2car/fran	\$239,000	248-851-1900	realestateone.com/26120728
38583 Grenada	4BR/3BA/2car/col	\$238,000	248-348-6430	realestateone.com/26154751
35709 Grenada	4BR/2.5BA/1car/fran	\$209,900	734-591-9200	realestateone.com/26108359
28647 Bayberry Park 26	2BR/2.1BA/2car/condo	\$200,000	734-326-2000	realestateone.com/26049928
14627 Fairway	3BR/2BA/2car/fran	\$193,000	248-348-6430	realestateone.com/26119185
33910 Orangeflawn	4BR/1.1BA/3car/fran	\$179,330	734-455-7000	realestateone.com/26053862
11842 Farmington Road 60	2BR/2BA/1car/condo	\$174,900	734-326-2000	realestateone.com/26102038
31802 Delaware	3BR/1BA/1car/fran	\$162,000	734-591-9200	realestateone.com/26038226
<b>MELVINDALE</b>				
17554 Hill	3BR/1BA/2car/hp/dtd	\$89,900	248-851-1900	realestateone.com/26153865
<b>MILFORD</b>				
1345 Forest Ridge	5BR/3.1BA/3car/finwp	\$994,000	248-363-8300	realestateone.com/26144127
450 W. Maple	5BR/4.1BA/3car/fran	\$675,000	248-684-1065	realestateone.com/26016182
680 Midford Glen	3BR/2.1BA/2car/fran	\$272,900	248-684-1065	realestateone.com/26126691
3256 Grand Vista	2BR/1BA/1car/fran	\$239,900	248-684-1065	realestateone.com/26067449
<b>NORTHFIELD</b>				
409 East Shore	4BR/3BA/1car/fran	\$468,000	734-591-9200	realestateone.com/26116617
296 Delaware Rd.	3BR/1.1BA/2car/fran	\$164,900	734-591-9200	realestateone.com/26080467
9189 Lake Pine Unit #4	2BR/2BA/2car/condo	\$154,900	734-591-9200	realestateone.com/26136288
<b>NORTHVILLE</b>				
18415 Clairmont Circle	4BR/2.1BA/3car/deck	\$674,900	248-348-6430	realestateone.com/26103957
17664 Lake View Circle	2BR/2BA/2car/condo	\$399,900	248-348-6430	realestateone.com/26080570
42322 Norwood Court	3BR/2.1BA/1car/condo	\$189,900	248-851-1900	realestateone.com/26066943
<b>NOVI</b>				
45856 Bristol Circle	4BR/2.1BA/3car/2-story	\$574,900	248-851-1900	realestateone.com/26128049
24057 Broadmoor Park	BR/BA/1car/vacant	\$500,000	248-348-6430	realestateone.com/25032383
45776 Irvine Dr.	4BR/2.1BA/2car/col	\$439,999	248-348-6430	realestateone.com/26090915
45788 Irvine Dr.	4BR/2.1BA/2car/col	\$419,900	248-348-6430	realestateone.com/26032156
26461 Fieldstone	3BR/3.1BA/2car/condo	\$399,900	248-348-6430	realestateone.com/26134218
22372 Heatherbrae Way	3BR/2.5BA/2car/hp/dtd	\$349,000	248-348-6430	realestateone.com/26008588
45768 Roundview	4BR/2.1BA/2car/col	\$345,000	248-348-6430	realestateone.com/26100814
28938 Heartstone	3BR/2.1BA/2car/col	\$319,900	248-348-6430	realestateone.com/26104972
41447 Glynne	4BR/2.1BA/2car/col	\$305,000	248-348-6430	realestateone.com/26117177
45069 Hastingscross	4BR/2.1BA/2car/col	\$300,000	248-348-6430	realestateone.com/26108297
24703 Jamestowne	4BR/2.5BA/1car/fran	\$299,900	248-348-6430	realestateone.com/26108746
23876 Heartwood Dr.	4BR/2.1BA/2car/fran	\$294,900	248-348-6430	realestateone.com/26020361
24659 Edgewood Ct. N	3BR/2.1BA/2car/fran	\$279,900	248-348-6430	realestateone.com/26095474
115 N. Haven St.	3BR/1.5BA/2car/2-story	\$275,000	248-851-1900	realestateone.com/26068771
24382 Jamestowne	4BR/2.5BA/2car/fran	\$264,900	248-348-6430	realestateone.com/26112050
31008 Eagle Dr.	2BR/2BA/2car/fran	\$235,000	248-851-1900	realestateone.com/26112053
40187 Ladene Lane	2BR/2BA/2car/fran	\$214,900	248-348-6430	realestateone.com/25072285
31092 Arlington Circle	2BR/2.1BA/2car/condo	\$200,000	248-851-1900	realestateone.com/26088614
23672 E. LeBost	3BR/2BA/1car/fran	\$185,000	248-348-6430	realestateone.com/26102511
39482 Country Ln.	2BR/2.1BA/1car/condo	\$179,900	248-851-1900	realestateone.com/26062656
24360 Willow Lane	3BR/1.1BA/2car/patio	\$179,777	248-684-1065	realestateone.com/26150462
238				

# Community HEALTH GUIDE

SAINT  
JOSEPH  
MERCY  
HEALTH SYSTEM  
A MEMBER OF TRINITY HEALTH

Fall 2006

Classes  
Programs  
Support Groups



# Community |



## Welcome

### St. Joseph Mercy Hospital

5301 McAuley Drive  
Ypsilanti, MI 48197  
734-712-3456

### Saint Joseph Mercy Livingston Hospital

620 Byron Road  
Howell, MI 48843  
517-545-6000

### Saint Joseph Mercy Saline Hospital

400 Russell Street  
Saline, MI 48176  
734-429-1500

## What's Inside

- 3 | Cancer Education and Research
- 4 | Children's, Adolescent and Teen Health
- 5 | CPR Basic Life Support
- 5 | Health Exploration Station
- 6 | Diabetes Education
- 6 | Volunteering
- 7 | Exercise and Fitness
- 7 | Special Events
- 8 | Healthier Living
- 8 | Healthy Cooking
- 9 | Heart Cardiovascular
- 9 | Lungs Pulmonary
- 10 | Pregnancy, Childbirth and Infant Care
- 11 | Specialty Services at Ellen Thompson Women's Health Center
- 12 | Seniors
- 12 | Substance Abuse Education
- 13 | Support Groups
- 14 | Weight and Healthy Lifestyle
- 14 | Weight Loss Programs
- 15 | Women's Health

### Mission Statement

We serve together in Trinity Health, in the spirit of the Gospel, to heal body, mind and spirit, to improve the health of our communities and to steward the resources entrusted to us.

### Core Values

- Respect
- Social Justice
- Compassion
- Care of the Poor and Underserved
- Excellence

Saint Joseph Mercy Health System and its physician partners provide a comprehensive range of health care services for residents in Washtenaw, Livingston, Jackson, Lenawee, Monroe and western Wayne counties.

## Send a Gift!

Send flowers, candy, balloons or baby gift items to St. Joseph Mercy Hospital patients by ordering online at [www.sjmercyhealth.org](http://www.sjmercyhealth.org) with free delivery to patient rooms. You can also shop online to purchase HMR® food replacement meals, shakes and bars delivered directly to your home.

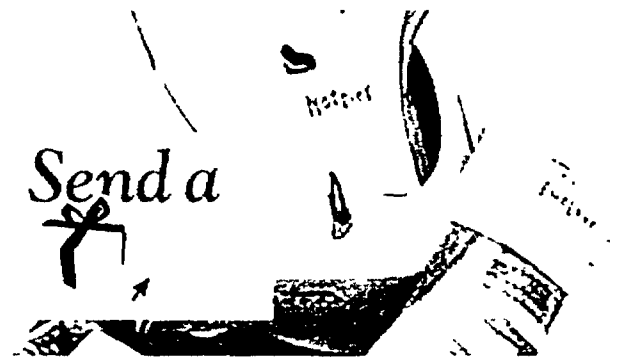

## Cancer Education and Research

### Art for Fun Workshop

Local artists introduce their art technique to adult cancer patients. Participants experience creative activity, have fun, meet new people and develop a piece of artwork.

#### Ypsilanti/Cancer Center:

Third Thursday monthly; 4-6 p.m.  
734-712-5948

### Cancer Prevention, Cancer Survival Cooking Class Series

Get on the right track to healthy eating with cooking demonstrations, tasting and nutrition presentations. Free eight-week series, no class during holiday weeks. Registration required.

#### Ypsilanti/Women's Health Center:

Wednesdays, September 13 – November 1 and November 8 – January 17; 11 a.m.-12:30 p.m.  
734-712-5800

### Cancer Research Studies - Seeking Volunteers

**Hot Flash Study:** Men receiving prostate cancer treatment and having hot flashes can participate in this study evaluating the drug Cabazitaxel.

#### Sleep problems for patients receiving cancer treatment:

Patients receiving cancer treatment are invited to participate in a study evaluating the herb Valerian.

Call 877-590-5995 for more information.

### Look Good, Feel Better

A free workshop by the American Cancer Society for women undergoing treatment for cancer. Participants will receive tips on skin care and make-up and learn about wigs, hats and turbans. Pre-registration required.

#### Ypsilanti/Cancer Center:

Third Wednesday monthly, 11:30 a.m.-1:30 p.m.  
734-971-4300

### Prostate Screening

If you're a white male age 50 to 70, are an African American male age 40 to 70, or have a family history of prostate cancer, you are eligible for a free first-time prostate cancer screening. Repeat screenings are \$15 in subsequent years.

#### Ypsilanti/Cancer Center:

Thursday, September 28 and October 26; 4:30-5:30 p.m.  
734-712-5400/800-231-2211

## Building our team together...

Seeing to the welfare of our neighbors and training the next generation of medical professionals are driving forces at Saint Joseph Mercy Health System. A not-for-profit system, we focus on what truly matters: healing, education, compassion, and respect for patients and staff. Each of our facilities offer unique opportunities in which you can both serve and excel.

St. Joseph Mercy Hospital (Ann Arbor),  
St. Joseph Mercy Livingston Hospital (Howell),  
and St. Joseph Mercy Saline Hospital (Saline)

Apply online at  
[www.sjmercyhealth.org](http://www.sjmercyhealth.org)



## The ABC's of Asthma: Childhood Asthma

An overview of asthma, warning signs of an emergency, common triggers, how to maintain an active lifestyle, and current medications. For students, ages 5-7, and their parents. Each child will receive a FREE spacer and peak flow meter. \$30

**Howell/SJM Livingston Hospital:**

Tuesday, September 19; 6:30-8:30 p.m.

734-712-5800

## Asthma 101: Effective Strategies/Child's Asthma

This program for students, ages 8-13, and their parents covers an overview of asthma, warning signs of an emergency, common triggers, how to maintain an active lifestyle, and current medications. Each child will receive a FREE spacer and peak flow meter. \$30

**Canton/Canton Health Center:**

Thursday, October 12; 6:30-8:30 p.m.

**Ypsilanti/Women's Health Center**

Saturday, October 21; 1-3 p.m.

734-712-5800

## Comprehensive Asthma Program

Program consists of six weekly education sessions that occur during the school day and enable students to gain control over their condition. Call to register.

734-712-5206

## Girls Just Wanna Have Fun Night

Provided by Girls Empowered, this program is for girls ages 6-13. Stand up and be heard! Learn how to be assertive and deal with peer conflict. Includes dancing, cardio kickboxing and a snack. \$25

**Ypsilanti/Women's Health Center:**

Friday, October 6; 6-9 p.m.

734-712-5800

## Heart-to-Heart Conversation for Mothers and Daughters on Puberty and Growing Up

Provides mothers and daughters ages 9 to 12 information about normal development, common concerns that affect girls, special concerns for girls with chronic health conditions. \$45. Call to register. \$25 for students.

**Ypsilanti/Women's Health Center:**

Sunday, September 24; 1-5 p.m.

**Canton/Canton Health Center:**

Sunday, November 12; 1-5 p.m.

734-712-5400/800-231-2211

## Mom and Daughter Self-Esteem Workshop

Provided by Girls Empowered, this workshop will focus on learning about self-esteem and confidence, why they matter and how to get them. For girls 6-12. \$25 mother-daughter pair

**Ypsilanti/Women's Health Center:**

Saturday, November 11; 1-2:30 p.m.

734-712-5800

## Nite Out for Scouts

Provided by Girls Empowered. Scouts come to us for your troop meeting! This evening is specially designed for local scout troops to earn badges. Fee includes snack and patch. \$25

**Ypsilanti/Women's Health Center:**

Friday, December 1; 6-9 p.m.

734-712-5800

## ShapeDown

Parents and kids work together in this innovative 10-week weight management program to learn how healthy eating, an active lifestyle and effective communication promote weight loss. Free orientation. \$400 (may be covered by insurance).

734-712-5800

## Advanced ShapeDown

Ongoing meetings held every other Monday; 6:30-8 p.m. A parent-child exercise session is held on the alternate Mondays, for a total of 10 sessions. \$175. 10 sessions (may be covered by insurance).

734-712-5800

## "Surgi-nauts" Pre-operative Teaching Program

This unique program helps children and their parents understand the surgical process, thus easing their fear of surgery. A tour is included.

**Howell/SJM Livingston Hospital:**

First and third Saturday monthly at 10 a.m.

734-712-5400/800-231-2211

## Transitions

Therapy group to help high school age girls adjust to the stress of being a teen. Topics include social pressure, fitting in, mood swings, body image, academic pressure. Groups form throughout the year. Fee involved (may be covered by insurance).

**Ann Arbor/Behavioral Services:**

734-786-8032



Health Exploration Station is a community resource for health care professionals and the public. We offer a variety of health programs, including seminars, workshops, and continuing education courses. Our goal is to provide the public with the knowledge and skills necessary to take control of their health.

Visit [www.healthexplorationstation.com](http://www.healthexplorationstation.com) or call 734-398-7518.

### Adult & Pediatric CPR & First Aid Initial Certification

This initial class covers CPR, choking, AED and first aid for adult, child and infant. This class is for day care providers, teachers and anyone who requires American Heart Association heartsaver class for their job. \$90

#### Howell/SJM Livingston Hospital:

Saturday, November 18, 8:30 a.m -4:30 p.m  
 517-545-6517

### Adult & Pediatric Heartsaver CPR

American Heart Association CPR course covers adult, child and infant CPR, foreign body airway obstruction maneuver and automated external defibrillation (AED). This heartsaver class is recommended for day care providers, teachers, and anyone who requires CPR for employment. Prerequisite for First Aid class. \$50

#### Howell/SJM Livingston Hospital:

Tuesday, October 17, December 19; 6-10:30 p.m  
 517-545-6517

### Basic Life Support

Designed by the American Heart Association for healthcare providers, this course teaches the skills of CPR for all ages (including ventilation with barrier device, mask and bag-mask device) use of AED and relief of foreign body airway obstruction. Certification is valid for 2 years, book included. Initial Certification - \$125. Renewal - \$65

#### Howell/SJM Livingston Hospital:

Call for dates and times.  
 517-545-6517

### CPR Family and Friends

This American Heart Association class is for community members over the age of 16 who are interested in learning the basic skills necessary to respond to emergencies. This course does not meet the requirements for persons seeking a credential for CPR. \$35

#### Ypsilanti/Women's Health Center:

Tuesday, October 3, December 12, 6-9 p.m  
 Monday, November 6, 6-9 p.m  
 734-712-5800

#### Howell/SJM Livingston Hospital:

Thursday, September 28, October 26, November 30, 7-9:30 p.m  
 517-545-6517

### First Aid

American Heart Association training program that covers basic first aid information and techniques for injury, sudden illness, and trauma. An adult or pediatric CPR class with AED is a prerequisite for First Aid. \$35

#### Howell/SJM Livingston Hospital:

Thursday, October 5, December 7, 6:30-10 p.m  
 517-545-6517



# Diabetes Education

## Diabetes Awareness Day

Learn more about diabetes and how to take care of yourself or a loved one with health screenings, diabetes product information, healthy cooking demonstrations, exercise for diabetes (seated participation), food screenings, door prizes, book sales, and "Ask the Pharmacist" Registration recommended \$5

### Ypsilanti/Women's Health Center:

Saturday, November 4, 8:30 a.m. - 12:30 p.m.

734-712-5800

## Diabetes Education

Live well with diabetes. Learn how to control your blood sugar, eat properly and prevent complications. This program is a combination of individual and group sessions. Fee involved (may be covered by insurance). Physician referral required. Call for an appointment.

### Ypsilanti/Women's Health Center:

734-712-2431

### Howell/SJM Livingston Hospital:

517-545-6125

## Insulin Pump Program

Learn about the benefits of insulin pump therapy for Type 1 Diabetes. Explore different insulin pumps, experience wearing a pump and review carbohydrate counting. Fee involved (may be covered by insurance). Physician referral required.

### Ypsilanti/Women's Health Center:

734-712-2431

### Howell/SJM Livingston Hospital:

734-712-2431



## Intensive Insulin Management

Learn strategies to achieve better blood sugar control through matching insulin with carbohydrate intake. For individuals who have Type 1 Diabetes or who take three or more insulin injections per day. Fee involved (may be covered by insurance). Physician referral required. Call for an appointment.

### Ypsilanti/Women's Health Center:

734-712-2431

### Howell/SJM Livingston Hospital:

734-712-2431

## What's New and No Longer True in Diabetes Care

Learn about how diabetes is diagnosed and treated and new research in diabetes while enjoying a healthy meal. Open to people with diabetes and their support people. Dinner is provided at 5:30 p.m., speaker begins at 6 p.m. Registration required. Free.

### Ypsilanti/Women's Health Center:

Tuesday, December 5, 5:30-7 p.m.

734-712-2431

## Volunteering

### Hospice

Provide support and comfort to terminally ill patients and their families, assist in our office or on special projects. Training required - call to receive information packet and to pre-register.

### Ann Arbor/Saint Joseph Mercy Hospice:

734-327-3413

### Howell/Saint Joseph Mercy Livingston Hospice:

517-540-9125

### Hospice/Home Care Speakers' Bureau:

734-327-3413

## Community Support

### Hospitals

We're looking for volunteers to assist patients and staff. Call for details and to make an appointment.

### Ypsilanti/St. Joseph Mercy Hospital:

734-712-4159

### Howell/SJM Livingston Hospital:

517-545-6296

### Saline/SJM Saline Hospital:

734-429-1692

For more information or to register, visit [www.sjmercyhealth.org](http://www.sjmercyhealth.org) or call 734-712-5800. All classes are held and held at the Holy Thompson Women's Health Center. Sessions held the following dates: September 11 – October 27 and November 6 – December 21

			Fee
Ballet Fitness	Mondays	1-2 p.m.	\$75
Greek Dancing	Mondays (9/18 & 25; 11/13 & 20)	6:15-7 p.m.	\$15
Greek Dancing	Tuesdays (9/19 & 26; 11/14 & 21)	11:30 a.m.-12:05 p.m.	\$10
Pilates Matwork	Tuesdays	5:30-6:30 p.m.	\$68
Pilates Matwork	Thursdays*	5:30-6:30 p.m.	\$68
Strength Training	Mondays	12:15-12:45 p.m.	\$30
Strength Training	Mondays	4:15-5 p.m.	\$40
Strength Training	Tuesdays	12:15-12:45 p.m.	\$30
Strength Training	Wednesdays*	4:15-5 p.m.	\$40
Strength Training	Thursdays*	11:30 a.m.-12 p.m.	\$30
Tai Chi	Fridays	12:05-12:55 p.m.	\$65
Yoga	Mondays	11:30 a.m.-12:05 p.m.	\$35
Yoga	Wednesdays	12:15-12:50 p.m.	\$35
Yoga	Wednesdays*	5:30-6:30 p.m.	\$68

No classes after 4 p.m. on Nov. 22. No classes on November 23-24. Fees will be adjusted.

## One-time Specialty Fitness Classes

			Fee*
Increasing Bone Density & Strength	Tuesday, September 19	1-2 p.m.	\$30*
Increasing Bone Density & Strength	Thursday, October 19	1-2 p.m.	\$30*
Increasing Bone Density & Strength	Tuesday, November 14	2-3 p.m.	\$30*
Increasing Bone Density & Strength	Thursday, December 7	2:30-3:30 p.m.	\$30*
Improving Your Posture	Tuesday, October 17	2-3 p.m.	\$30*
Improving Your Balance	Thursday, November 30	1-2 p.m.	\$30*
Restorative Yoga	Saturday, November 11	9:30-11:30 a.m.	\$40
Yoga Cleansing & Detox	Saturday, October 7	9:30-11:30 a.m.	\$40
Yoga for Back Pain	Saturday, October 21	9:30-11:30 a.m.	\$40

\*Fee includes the one-time equipment

### 2006 Dinner at Eight

Proceeds will support the Saint Joseph Mercy Saline Hospital Imaging Center project.

#### Ann Arbor/Travis Pointe Country Club:

Saturday, October 14; 7 p.m.

734-712-5412

### 2006 Saint Joseph Mercy Livingston Harvest Ball

Proceeds will benefit the Warren R. and Lauraine A. Hoenscheid Cancer Center at Woodland Health Center

#### Brighton/Lakelands Golf and Country Club:

Saturday, November 4; 6:30 p.m.

734-712-8684

### 2006 St. Joe's Holiday Ball

Funds raised from this year's Holiday Ball will support the construction of the new patient towers and directly benefit the Surgical Intensive Care Unit (SICU) at St. Joseph Mercy Hospital.

#### Ypsilanti/EMU Convocation Center:

Saturday, December 2; 7 p.m.

734-712-4040

## Anxiety Management Group

Therapy group focusing on cognitive behavioral interventions to reduce and manage symptoms of anxiety. Topics include understanding physical symptoms, addressing negative thinking, and learning relaxation exercises. Fee involved (may be covered by insurance).

Ann Arbor Behavioral Services

734-786-8032

## Freedom from Smoking

Sponsored by Key Development Center, this program creates a supportive environment to assist in kicking the habit. Includes stress management, weight control, assertive communication and exercise. 8 weeks, free orientation session on October 4. Includes relaxation CD and workbook. \$150.

### Howell/SJM Livingston Hospital:

Wednesdays, beginning on October 4: 6:30-7:30 p.m.

517-545-6517

## Health Information Library

Books, journals, videos and pamphlets available on a variety of health and wellness topics. Stop in or call for a packet of information.

### Ypsilanti/Reichert Health Center:

Monday-Thursday, 9 a.m.-4 p.m.

734-712-5177

## Hypnosis for Smoking Cessation

Learn about the power of hypnotic conditioning with behavior modification techniques to help you kick the habit without gaining weight. First 45 minutes free to see if the program is for you! \$69 payable after free orientation period or \$59 if you register online at <http://www.caswillpower.com>.

### Ypsilanti/Administration Services Auditorium:

Saturday, October 7: 10 a.m.-12 p.m.

800-848-2822

## Washtenaw Asthma Coalition

The Washtenaw Asthma Coalition is a community-wide collaboration to prevent the development of asthma and to improve the quality of life for those living with the illness.

### Ypsilanti/Administration Services:

Tuesday, September 19, November 21: 7:30-9 a.m.

734-712-4543

# Healthy Cooking

Classes are held at the Ellen Thomson Women's Health Center Culinary Studio and are \$30 unless otherwise noted. For a complete description of these classes, dishes you will be making and to register online, visit [www.sjmercyhealth.org](http://www.sjmercyhealth.org) or call 734-712-5800.

Class	Day/Date	Time
Vegetarian Wonders	Monday, September 25	5:30 p.m.
Get Hooked on Fish	Thursday, September 28	5:30 p.m.
Healthy Fall Harvest Menu	Monday, October 2	5:30 p.m.
Whole Grains Exploration	Monday, October 9	5:30 p.m.
Gluten Free Cooking	Tuesday, October 10	5:30 p.m.
Try Thai	Monday, October 16	5:30 p.m.
Living Well with Diabetes	Monday, October 23	5:30 p.m.
Get Hooked on Fish 2	Thursday, November 2	5:30 p.m.
Mediterranean Style Cooking	Monday, November 6	5:30 p.m.
La Cucina Italiana	Thursday, November 9	5:30 p.m.
Joy of Soy 2	Monday, November 13	5:30 p.m.
Soups On!	Monday, November 20	5:30 p.m.
Kid's Cook 1	Monday, December 4	5:30 p.m.
Marvelous Meats	Thursday, December 7	5:30 p.m.
Pasta, Pasta!	Monday, December 11	5:30 p.m.
Healthy Holiday Gifts from Your Kitchen *	Monday, December 18	6:30 p.m.
Whole Grains Exploration	Monday, January 8	5:30 p.m.
Try Thai	Monday, January 15	5:30 p.m.

### **"...And the Beat Goes On"**

Cardiovascular educational classes on diet, risk factors and managing stress are available free of charge. Classes are 45 minutes long and take place on Wednesdays at 8:45 a.m., 11:30 a.m., 2:15 p.m. and 5 p.m. No registration is necessary.

**Ypsilanti/Michigan Heart & Vascular Institute:**  
734-712-3105

### **Cardiac Rehabilitation**

Supervised exercise program for individuals with cardiovascular disease or significant risk factors for developing heart disease. Fee involved.

**Ypsilanti/Michigan Heart & Vascular Institute:**  
734-712-3105

**Howell/SJM Livingston Hospital:**  
517-545-6385

### **Healthy Hearts Yoga**

Gentle stretching, yoga postures and techniques for relaxation and stress management. Ideal for people with or at risk for cardiovascular disease. Free trial class! \$60 six sessions.

**Ypsilanti/Michigan Heart & Vascular Institute:**  
Tuesdays: 5:30-6:45 p.m.  
734-712-3546

### **Heart of a Woman Clinic**

Learn more about your cardiovascular health and seek guidance from a female cardiologist. Fee involved (may be covered by insurance).

**Ypsilanti/Women's Health Center:**  
Wednesdays: 9 a.m.-noon  
734-712-5100

### **Heart of a Woman Lecture Series**

Upcoming lecture in October with cardiologist Dr. Barbara Kong. Watch our website for further details at [www.mhvi.org](http://www.mhvi.org) or call 734-712-3583 for information.

**Ypsilanti/Michigan Heart & Vascular Institute:**  
734-712-3583

### **Pulmonary Rehabilitation**

Exercise and educational program for those who suffer from lung disease. Supervised by a respiratory therapist. Fee involved.

**Ypsilanti and Howell:**  
734-712-5367

### **Heart Walk**

Join the American Heart Association's Learn & Live Heart Walk! Registration opens at 8 a.m. and "The Walk" begins at 9:15 a.m. at Washtenaw Community College.

**Ann Arbor/Washtenaw Community College:**  
Saturday, September 30; 8 a.m.-12 p.m.  
517-784-4378

### **Legs for Life**

National screening event for peripheral vascular disease (PVD). Screening includes a four-point blood pressure check, arterial Doppler study, stroke screening and consultation with a vascular specialist. By appointment only. Screenings are limited and fill quickly.

**Ypsilanti/Michigan Heart & Vascular Institute:**  
Tuesday, September 19; 8 a.m.-4:30 p.m.  
800-231-2211

### **New Directions in Heart Failure**

Patients, families and friends are invited to learn the most recent information on the treatment of heart failure. Watch for more information on our website [www.mhvi.org](http://www.mhvi.org) or call 734-712-3583.

**Ypsilanti/Michigan Heart & Vascular Institute:**  
734-712-3583

### **Stress and Lifestyle Management**

Stress is a normal part of life, but when it becomes unmanageable it can affect our lives in a negative way. Call for dates and times. \$100.

**Ypsilanti/Michigan Heart & Vascular Institute:**  
734-712-3583

### **Vascular Rehabilitation**

Ongoing medically supervised exercise program for people diagnosed with peripheral artery disease. Program includes education and medical supervision. Fee involved.

**Ypsilanti/Michigan Heart & Vascular Institute:**  
734-712-2459

## Baby Basics

This class is designed for first-time parents to learn the skills of feeding, bathing, diapering, skin care, soothing and safety. In addition, new parents will learn breast-feeding techniques including how to pump, storage and breast care. \$40

### Brighton/Woodland Health Center

Saturday, January 20, 9 a.m.-2:30 p.m.

517-545-6517

## Breastfeeding Preparation

Class offers expectant mothers and their partners (optional) instruction on breastfeeding techniques. \$20

### Ypsilanti/Women's Health Center:

Monday, 7:30-9:30 p.m. or Saturday, 11 a.m.-1 p.m.

Call for dates or register online

### Howell/SJM Livingston Hospital:

First Tuesday monthly: 4-6 p.m.

Third Thursday monthly: 7:30-9:30 p.m.

734-712-5400/800-231-2211

## Childbirth Education

Child and delivery preparation class for expectant mothers and their partners or support coach. Information regarding natural childbirth techniques, relaxation exercises, medical intervention and cesarean birth is included. \$65

### Ypsilanti/Brighton/Howell:

734-712-5400/800-231-2211

## Family Birth Center Tours

Learn the birth facility of your choice. Pre-registration required!

### Ypsilanti/St. Joseph Mercy Hospital:

Monday and Thursday evenings, call for dates and times or register online

### Howell/SJM Livingston Hospital:

Call for dates and times or register online

734-712-5400/800-231-2211



## FIRST TIME PARENT CLASSES

Separate training classes for moms and dads held at the same time! Register online at [www.sjmercyhealth.org](http://www.sjmercyhealth.org) or call 800-231-2211.

### Survival Skills for New Moms

Prenatal class designed for women expecting their first baby. You'll learn lots of practical information on surviving those first few weeks at home with baby, coping with yourself, juggling visitors and managing future care. \$25

### Boot Camp for New Dads

Taught by men, this class teaches first-time fathers practical information on parenthood, baby care, becoming a family and supporting the new mom. You'll even get hands-on experience holding and comforting a baby with the help of "veteran" dads who bring their babies to class. \$25

### Ypsilanti/Women's Health Center:

Saturday, October 21: 9 a.m.-noon

### Canton/Canton Health Center:

Saturday, September 23, November 11: 9 a.m.-noon

### Howell/SJM Livingston Hospital:

Saturday, October 7, December 2: 9 a.m.-noon

## Happiest Baby on the Block

Are you ready to be a parent? Sleepless nights, crying baby, parent stress... New parents will learn how to help babies sleep longer and how to soothe even the fussiest infant in minutes. DVD and CD included. \$30

### Ypsilanti/Women's Health Center:

Wednesdays, call for dates and times or register online.

734-712-5400/800-231-2211

## Infant Care

Learn about basic newborn care. Includes information on feeding, burping, bonding, diapering, bathing, infant safety and much more! \$20 per couple

### Ypsilanti/Howell

Call for dates and times or register online.

734-712-5400/800-231-2211

## Birth Center Video Tour

Take a tour of the Family Birth Center at St. Joseph Mercy Hospital online at [www.sjmercyhealth.org](http://www.sjmercyhealth.org). Just click on Women & Children, then Family Birth Centers, and enjoy the 10-minute video tour!

## Infant Massage

This four-week course guides families through a research-based massage routine that promotes healthy parent-child relationships, supports physical growth and development, and enhances vital early brain connections while nurturing growing communications in families. \$75

### Ypsilanti/Women's Health Center:

Mondays, September 18-October 9; 7-8:30 p.m.

Wednesdays, November 1-22, December 6-27; 7-8:30 p.m.

734-712-5800

## Pain Management During Labor

Class reviews different relaxation techniques and answers questions about available options, including labor epidurals. \$10 per couple.

### Ypsilanti/Women's Health Center:

Thursday, September 21, November 9, January 11; 7:30-9:30 p.m.

734-712-5400/800-231-2211

## Pet Preparation Before Baby Comes

Educates dog and cat owners about common behavior problems that occur and strategies to prevent them. \$20

### Ypsilanti/Women's Health Center:

Tuesday, January 9, 7-8:30 p.m.

### Howell/SJM Livingston Hospital:

Tuesday, October 10, November 14, December 12; 7-9 p.m.

734-712-5400/800-231-2211

## Pregnancy and Newborn Loss Memorial Service

This non-denominational service provides a setting where your close friends and family members can gather to remember your baby.

### Ypsilanti/St. Joseph Mercy Hospital Chapel:

Monday, October 2, 2006; 7:30 p.m.

734-712-0344

## Prenatal/Post Partum Aquatic Exercise Classes

Provides women an opportunity to exercise safely during pregnancy and post partum recovery. Unique classes offer numerous benefits. \$49 seven week session.

### Canton/Summit in the Park:

Thursdays, September 14-October 26; 7-8 p.m.

Thursdays, November 9-December 21; 7-8 p.m.

734-712-5800

## What Now? From Maternity to Motherhood

Drop in monthly meeting for new moms and her baby. An informal discussion to share ideas and learn more about parenting for yourself and your newborn. Free.

### Ypsilanti/Women's Health Center:

Wednesday, October 4, November 1, December 6, 10 a.m.-noon

734-712-5400/800-231-2211

## Parents' Newsletter

FREE! Expectant and new parents can receive a weekly e-mail newsletter. Sign up by visiting [www.sjmercyhealth.org](http://www.sjmercyhealth.org) today!

## *Specialty Services*

### Massage Therapy & Bodywork Services

Nationally certified massage therapists use techniques including myofascial, neuromuscular, cranial sacral, reflexology, Swedish, pregnancy, sports, repetitive use injury, and seated massage. Gift certificates available. Call for rates and appointment.

734-712-5911

### Personal Fitness Assessments

Baseline measurements include body composition, BMI, strength, flexibility and other assessments. Call for rates and appointment.

734-712-5800

### Personal Training

Nationally certified trainers design a program to meet your specific needs. Call for rates and appointment.

734-712-5800

### Women's Health Boutique

Retail shop featuring wellness and health specialty items, as well as great gift ideas. Visit [www.sjmercyhealth.org](http://www.sjmercyhealth.org) to shop online at the boutique!

Monday-Thursday: 10 a.m.-6 p.m. • Friday: 10 a.m.-1 p.m.

734-712-5806

## Confronting Your Mortality

This support group assists members in making peace with the past, finding purpose in the present and hope for the future. \$15

### Ypsilanti/Senior Health Building:

Fridays, September 22-October 20; 10-11:30 a.m.  
734-712-2804

## Geriatric Social Work Services

Experienced therapists specializing in aging issues provide assessment, counseling and information about community resources for aging adults and their families. Fee involved, partially covered by Medicare.

### Ypsilanti/Senior Health Building:

734-712-5189

## LifeLine

Phone response system that links subscribers to 24-hour emergency assistance at the touch of a button. Especially suited for those living alone or with special needs. Installation, plus a monthly fee involved.

### Ypsilanti/Senior Health Building:

734-712-3922

### Howell/SJM Livingston Hospital:

517-545-6427

## Medicare/Medicaid Assistance Program

Peer counselors are available to answer questions regarding Medicare, health and long term insurance or doctor/hospital bills. Appointment required.

### Ypsilanti/Senior Health Building:

Wednesdays; 9:30-11:30 a.m.

734-712-3625/800-803-7174

## Substance Abuse, Education and Support

### Dawn Farm Education Series

This series developed to provide accurate information about chemical dependency, recovery and related issues. Visit [www.dawnfarm.org](http://www.dawnfarm.org) for more information.

### Ypsilanti/Administration Services:

Series begins Tuesday, October 17, 7:30-9:30 p.m.

734-485-8725

## Parenting for Prevention

This program explores existing prevention strategies and teaches new strategies to foster a safe, secure, protective environment for children. Runs concurrently with the evening 7-9 p.m. session.

### Ypsilanti/Women's Health Center:

Sundays, 6-7:30 p.m.

734-712-2851

## Osteoporosis - Building Better Bones

Learn about the symptoms of osteoporosis, latest treatments and how it can be prevented. Lunch provided. \$6 for Silver Advantage members, \$8 for guests.

### Ypsilanti/Senior Health Building:

Wednesday, October 18; 12-1:30 p.m.

734-712-2989

## Parkinson's Disease: Latest Updates

Learn what Parkinson's Disease is, how it can be treated and prevented. Lunch provided. \$6 for Silver Advantage members, \$8 for guests.

### Ypsilanti/Senior Health Building:

Wednesday, November 15; 12-1:30 p.m.

734-712-2989

## Prescription Assistance Program

If you are a patient at Senior Health Services and are unable to pay for your medications you may qualify for this ongoing program. Senior Health Services clinic patients only are eligible for the Prescription Assistance Program. Call for more information.

### Ypsilanti/Senior Health Building:

734-712-0164

## Questions About Your Bill?

Volunteers are available to assist you with questions related to billing, insurance and other financial issues. Individual sessions are scheduled each Wednesday morning by appointment. There is no charge for this service offered in partnership with Catholic Social Services of Washtenaw County.

### Ypsilanti/Senior Health Building:

734-712-3625

## Silver Advantage - A Program for Adults 50 and Over

Health, wellness and educational program specifically designed to help seniors better understand personal health issues. As a Silver Advantage member you will enjoy numerous benefits at no cost! Call for additional information.

Ypsilanti/Senior Health Building

734-712-2989

## The Growing Tree

Eight week educational support program for children ages 4 to 12 who are closely associated with someone abusing alcohol or drugs, or is in recovery. A concurrent parenting program teaches new strategies to foster substance abuse prevention in children - \$300 per child and up to two caretakers (\$100 for each additional child).

### Ypsilanti/Women's Health Center:

Sundays; 6-7:30 p.m.

734-712-2851



## Teens Using Drugs Series

Free workshop for parents, families, teens or people who work with teens.

**Part 1 - What To Know:** Learn how to understand and recognize the signs of teen substance abuse problems

**Part 2 - What To Do:** Learn how to respond to teens who may have substance abuse problems

**Ypsilanti/Brighton:** Tuesdays; 7:30-9 p.m. Call for dates. 734-973-7892

## Alzheimer's Caregiver Support Group

Senior Health Services has collaborated with the Alzheimer's Association to host a monthly support group for caregivers of those with Alzheimer's disease.

**Ypsilanti/Senior Health Building:**

Fourth Wednesday monthly; 6:30-8 p.m.

734-712-2513

## Alzheimer's Support Group

Peer support and information for caregivers of persons with Alzheimer's and other dementias.

**Hartland/Senior Center:**

Third Monday monthly; 6:30-8:30 p.m.

517-545-6023

## Arthritis Support Group

**Howell/SJM Livingston Hospital:**

Fourth Tuesday monthly; 12 p.m.

517-545-6289

## Breather's Club

Reduce the impact of lung disease and improve your breathing in this free support group.

**Ypsilanti/St. Joseph Mercy Hospital:**

Second Wednesday monthly

734-712-5367

**Howell/SJM Livingston Hospital:**

Second Tuesday monthly

517-545-6020

## Stroke Club

For stroke survivors and their caregivers, family and friends.

**Ypsilanti/St. Joseph Mercy Hospital:**

Second Wednesday monthly, 1:30-3:30 p.m.

734-712-4290

**Howell/SJM Livingston Hospital:**

Third Tuesday monthly, 12:30-2 p.m.

517-545-6710

## Survivors of Suicide Support Group

Adult grief support group for family members, friends coping with the suicide of their loved one.

**Howell/SJM Livingston Hospital:**

First Tuesday monthly; 7-8:30 p.m.

517-540-9125

## Cancer Support Groups

### Brain Tumor Support Group

**Ypsilanti/Cancer Center:**

Fourth Tuesday monthly; 7-8:30 p.m.

734-712-3658

### Breast Cancer Support Group

**Ypsilanti/Cancer Center:**

Third Thursday monthly; 7-8:30 p.m.

734-712-2920

### Prostate Cancer Support Group

**Ypsilanti/Cancer Center:**

Third Thursday monthly, 7-8:30 p.m.

734-712-3655

### Share and Care Cancer Support Group

Discussion group open to anyone diagnosed with cancer, their families and friends for support and information.

**Ypsilanti/Cancer Center:**

Second and fourth Wednesday monthly, 7-8:30 p.m.

734-712-3958

## Grief Support Groups

**Fowlerville/Senior Center:**

Adult drop-in support held first and third Monday monthly, 10-11:30 a.m.

517-540-9125

**Howell/Church of the Nazarene:**

Ongoing support group held every Wednesday monthly, 6:30-8 p.m.

517-545-6368

**Howell/SJM Livingston Hospice:**

Six-week 'Walking with Grief' series for adults who have lost a loved one

517-540-9125

**Howell/SJM Livingston Hospice:**

Individual and family grief counseling available for anyone grieving the loss of a loved one.

517-540-9125

## Support Groups (Cont.)

### Heart/Cardiovascular Support Groups

Amputee Support Group

734-712-3516

Atrial Fibrillation Support Group

734-712-0595

Group Heart-to-Heart Network

(for people with cardiovascular disease)

734-712-3852

For more information about other support groups, call the Michigan Self-Help Clearinghouse at 800-777-5556 (Monday-Friday, 10 a.m.-3 p.m.)

### Heart Failure Support Group

734-712-5100

Implanted Cardioverter Defibrillators Support Group

734-712-8036

Partners at Heart

(for spouses/significant others of people with cardiovascular disease)

734-712-3852

### Speakers Bureau

Saint Joseph Mercy Health System offers a wide range of health care presentations for community groups. To request a speaker visit [www.sjmercyhealth.org](http://www.sjmercyhealth.org) or call 734-712-2357.

## Weight and Healthy Lifestyle

Classes held at the Ellen Thompson Women's Health Center. For more information and to register, visit [www.sjmercyhealth.org](http://www.sjmercyhealth.org) or call 734-712-5800. All classes are \$30.

Class	Day/Date	Time
Maximizing Your Food Choices	Tuesday, September 19	6 p.m.
Finding Fats that Fit	Tuesday, September 26	6 p.m.
Fabulous Fiber	Tuesday, October 3	6 p.m.
Supermarket Sleuthing and Restaurant Survival	Tuesday, October 10	6 p.m.
Gluten Free Grocery Shopping Trip	Tuesday, October 24	6 p.m.
Maximizing Your Food Choices	Tuesday, November 7	6 p.m.
Food and Stress: Healthy Ways to Deal with Emotions and Food	Saturday, November 11	1 p.m.
Finding Fats that Fit	Tuesday, November 14	6 p.m.
Fabulous Fiber	Tuesday, November 21	6 p.m.
Supermarket Sleuthing and Restaurant Survival	Tuesday, November 28	6 p.m.

## Weight Loss Programs

### HMR Weight Management Programs – Free Orientation

**HMR® Ultimate Diet** provides a 12-week weight management program with a focus on healthy eating and lifestyle changes. **HMR® Ultimate Diet** is a 12-week program that focuses on healthy eating and lifestyle changes.

**Healthy Solutions®** is a 12-week weight management program that focuses on healthy eating and lifestyle changes. **Healthy Solutions®** is a 12-week program that focuses on healthy eating and lifestyle changes.

Ypsilanti/Women's Health Center:  
734-712-5540

### Hypnosis for Weight Reduction

Two courses are available that use hypnosis to help you lose weight. Each 45-minute session of the program is \$20. **Self-Hypnosis for Weight Reduction** is a 45-minute session for \$20. For more information, visit [www.selfhypnosis.com](http://www.selfhypnosis.com).

### Ypsilanti/Administration Services:

Sunday, October 7, 1 p.m.

### Howell/SJM Livingston Hospital:

Thursday, October 12, 6:30-8:30 p.m.  
800-848-2822

## NutriCare Fitness "On-The-Road"

Our unique nutrition and fitness weight management program is now available to come to your organization or business.

Call the Ellen Thompson Women's Health Center • 734-712-5800 for more information.

## Alternatives to Hysterectomy

Join us as a team of physicians from Saint Joseph Mercy Health System discuss options used to treat abnormal uterine bleeding and fibroids without major surgery. They will discuss medical management and outpatient surgical procedures such as hysteroscopy and endometrial ablation, as well as uterine artery embolization.

**Canton/Canton Health Center:** Tuesday, October 3; 6:30-8:30 p.m. (734-712-5400/800-231-2211)

## Female Sexual Health Series

This series is for women in mid-life who are experiencing changes in their sexual functioning.

- October 12 - The Female Sexual Dysfunction from the Medical Perspective
- October 26 - Female Sexual Health and Your Self Image as a Woman
- November 9 - Intimate Relationships: How to Make it Work with Your Partner (734-712-5800)

## Title XV Breast and Cervical Cancer Screening

You may qualify for no-cost screening through the Michigan Breast and Cervical Cancer Control Program. Participating clinics in Washtenaw and Livingston County provide safe, reputable and thorough screening, as well as follow-up care if needed. Women must be 40 years of age or older and meet certain income and insurance requirements to be eligible.

734-712-5800

Some classes are non-refundable, but are transferable. Call 800-231-2211 for more information.

## CLASS REGISTRATION FORM

Do you have a scholarship? Yes  No  Pending  ID# \_\_\_\_\_

Change in address or phone for registration since last registration? Yes  No

Change in address or phone for payor since last registration? Yes  No

Are there any special conditions or disabilities? Yes  Describe \_\_\_\_\_

CLASS SELECTION	PARTICIPANT INFORMATION	Office Use																																
<table style="width: 100%; border-collapse: collapse;"> <tr> <td style="width: 30%; text-align: center;">CLASS</td> <td style="width: 40%; text-align: center;">NAME OF CLASS</td> <td style="width: 30%; text-align: center;">COST</td> </tr> <tr> <td>1ST CHOICE _____</td> <td>_____</td> <td style="text-align: right;">\$ _____</td> </tr> <tr> <td>ALT CHOICE _____</td> <td>_____</td> <td style="text-align: right;">\$ _____</td> </tr> <tr> <td>ALT CHOICE _____</td> <td>_____</td> <td style="text-align: right;">\$ _____</td> </tr> </table>	CLASS	NAME OF CLASS	COST	1ST CHOICE _____	_____	\$ _____	ALT CHOICE _____	_____	\$ _____	ALT CHOICE _____	_____	\$ _____	<table style="width: 100%; border-collapse: collapse;"> <tr> <td colspan="2">FIRST NAME _____</td> </tr> <tr> <td colspan="2">LAST NAME _____</td> </tr> <tr> <td>BIRTHDATE _____</td> <td>GRADE _____ GENDER M <input type="checkbox"/> F <input type="checkbox"/></td> </tr> <tr> <td colspan="2">ADDRESS _____ CITY _____</td> </tr> <tr> <td>ST _____</td> <td>ZIP _____ PHONE _____</td> </tr> <tr> <td colspan="2">EMAIL _____</td> </tr> </table>	FIRST NAME _____		LAST NAME _____		BIRTHDATE _____	GRADE _____ GENDER M <input type="checkbox"/> F <input type="checkbox"/>	ADDRESS _____ CITY _____		ST _____	ZIP _____ PHONE _____	EMAIL _____		<table style="width: 100%; border-collapse: collapse;"> <tr> <td>CK <input type="checkbox"/></td> <td>CA <input type="checkbox"/></td> </tr> <tr> <td>CC <input type="checkbox"/></td> <td>CR <input type="checkbox"/></td> </tr> <tr> <td colspan="2">Total \$ _____</td> </tr> <tr> <td colspan="2">Disc _____</td> </tr> </table>	CK <input type="checkbox"/>	CA <input type="checkbox"/>	CC <input type="checkbox"/>	CR <input type="checkbox"/>	Total \$ _____		Disc _____	
CLASS	NAME OF CLASS	COST																																
1ST CHOICE _____	_____	\$ _____																																
ALT CHOICE _____	_____	\$ _____																																
ALT CHOICE _____	_____	\$ _____																																
FIRST NAME _____																																		
LAST NAME _____																																		
BIRTHDATE _____	GRADE _____ GENDER M <input type="checkbox"/> F <input type="checkbox"/>																																	
ADDRESS _____ CITY _____																																		
ST _____	ZIP _____ PHONE _____																																	
EMAIL _____																																		
CK <input type="checkbox"/>	CA <input type="checkbox"/>																																	
CC <input type="checkbox"/>	CR <input type="checkbox"/>																																	
Total \$ _____																																		
Disc _____																																		
<table style="width: 100%; border-collapse: collapse;"> <tr> <td rowspan="4" style="width: 15%; text-align: center; vertical-align: middle;"><b>Payor Name</b>  (Person Paying for Class(es))</td> <td style="width: 35%;">FIRST NAME _____</td> <td style="width: 35%;">LAST NAME _____</td> </tr> <tr> <td>ADDRESS _____</td> <td>CITY _____ ST _____ ZIP _____</td> </tr> <tr> <td>HOME PHONE ( _____ ) _____</td> <td>WORK PHONE ( _____ ) _____</td> </tr> <tr> <td>EMAIL _____</td> <td>BIRTHDATE _____ GENDER M <input type="checkbox"/> F <input type="checkbox"/></td> </tr> <tr> <td colspan="3"> <b>PAYMENT INFORMATION</b>    <input type="checkbox"/> CHECK    <input type="checkbox"/> CREDIT CARD    <input type="checkbox"/> OTHER    <input type="checkbox"/> CREDIT ON ACCOUNT                 </td> </tr> </table>	<b>Payor Name</b>  (Person Paying for Class(es))	FIRST NAME _____	LAST NAME _____	ADDRESS _____	CITY _____ ST _____ ZIP _____	HOME PHONE ( _____ ) _____	WORK PHONE ( _____ ) _____	EMAIL _____	BIRTHDATE _____ GENDER M <input type="checkbox"/> F <input type="checkbox"/>	<b>PAYMENT INFORMATION</b> <input type="checkbox"/> CHECK <input type="checkbox"/> CREDIT CARD <input type="checkbox"/> OTHER <input type="checkbox"/> CREDIT ON ACCOUNT			<table style="width: 100%; border-collapse: collapse;"> <tr> <td style="width: 20px; text-align: center; font-weight: bold; font-size: 24px;">1</td> <td><b>Make check payable to:</b> Saint Joseph Mercy Health System</td> </tr> <tr> <td style="text-align: center; font-weight: bold; font-size: 24px;">2</td> <td><b>Include payment:</b> Credit from account: \$ _____ \$ _____ <small>AMOUNT PAID</small></td> </tr> <tr> <td style="text-align: center; font-weight: bold; font-size: 24px;">3</td> <td><b>Enclose coupons, gift certificates or other discounts with this form</b></td> </tr> <tr> <td style="text-align: center; font-weight: bold; font-size: 24px;">4</td> <td><b>Mail entire form to:</b> Saint Joseph Mercy Health System Attn: Trinity Health Telemanagement P.O. Box 995 Ann Arbor, MI 48106</td> </tr> </table>	1	<b>Make check payable to:</b> Saint Joseph Mercy Health System	2	<b>Include payment:</b> Credit from account: \$ _____ \$ _____ <small>AMOUNT PAID</small>	3	<b>Enclose coupons, gift certificates or other discounts with this form</b>	4	<b>Mail entire form to:</b> Saint Joseph Mercy Health System Attn: Trinity Health Telemanagement P.O. Box 995 Ann Arbor, MI 48106													
<b>Payor Name</b>  (Person Paying for Class(es))		FIRST NAME _____	LAST NAME _____																															
		ADDRESS _____	CITY _____ ST _____ ZIP _____																															
		HOME PHONE ( _____ ) _____	WORK PHONE ( _____ ) _____																															
	EMAIL _____	BIRTHDATE _____ GENDER M <input type="checkbox"/> F <input type="checkbox"/>																																
<b>PAYMENT INFORMATION</b> <input type="checkbox"/> CHECK <input type="checkbox"/> CREDIT CARD <input type="checkbox"/> OTHER <input type="checkbox"/> CREDIT ON ACCOUNT																																		
1	<b>Make check payable to:</b> Saint Joseph Mercy Health System																																	
2	<b>Include payment:</b> Credit from account: \$ _____ \$ _____ <small>AMOUNT PAID</small>																																	
3	<b>Enclose coupons, gift certificates or other discounts with this form</b>																																	
4	<b>Mail entire form to:</b> Saint Joseph Mercy Health System Attn: Trinity Health Telemanagement P.O. Box 995 Ann Arbor, MI 48106																																	
<table style="width: 100%; border-collapse: collapse;"> <tr> <td rowspan="4" style="width: 15%; text-align: center; vertical-align: middle;"><b>Credit Cards</b>  Please complete entire section</td> <td style="width: 35%;">NAME _____</td> <td style="width: 50%;">TOTAL FEE (Required) \$ _____</td> </tr> <tr> <td><input type="checkbox"/> VISA    <input type="checkbox"/> MASTERCARD    <input type="checkbox"/> AM EXPRESS</td> <td>Sorry we cannot accept debit cards at this time</td> </tr> <tr> <td>CARD # _____</td> <td>EXP DATE _____</td> </tr> <tr> <td colspan="2">SIGNATURE (REQUIRED) _____</td> </tr> </table>	<b>Credit Cards</b>  Please complete entire section	NAME _____	TOTAL FEE (Required) \$ _____	<input type="checkbox"/> VISA <input type="checkbox"/> MASTERCARD <input type="checkbox"/> AM EXPRESS	Sorry we cannot accept debit cards at this time	CARD # _____	EXP DATE _____	SIGNATURE (REQUIRED) _____																										
<b>Credit Cards</b>  Please complete entire section		NAME _____	TOTAL FEE (Required) \$ _____																															
		<input type="checkbox"/> VISA <input type="checkbox"/> MASTERCARD <input type="checkbox"/> AM EXPRESS	Sorry we cannot accept debit cards at this time																															
		CARD # _____	EXP DATE _____																															
	SIGNATURE (REQUIRED) _____																																	

# Community Education Locations

## 1 St. Joseph Mercy Hospital

5301 McAuley Drive  
Ypsilanti, MI 48197  
Phone: 734-712-3456

### Ellen Thompson Women's Health Center

5320 Elliott Drive  
Ypsilanti, MI 48197  
Phone: 734-712-5800

### Michigan Heart & Vascular Institute

5325 Elliott Drive  
Ypsilanti, MI 48197  
Phone: 734-712-5205

### Saint Joseph Mercy Administration Services

5305 Elliott Drive  
Ypsilanti, MI 48197  
Phone: 734-712-3456

### Saint Joseph Mercy Behavioral Services

2006 Hogback Road  
Ann Arbor, MI 48105  
Phone: 734-786-2300

### Saint Joseph Mercy Cancer Center

5301 McAuley Drive  
Ypsilanti, MI 48197  
Phone: 734-712-5948

### Saint Joseph Mercy Reichert Health Center

5333 McAuley Drive  
Ypsilanti, MI 48197  
Phone: 734-712-5300

### Senior Health Building

5361 McAuley Drive  
Ypsilanti, MI 48197  
Phone: 734-712-5189

## 2 Saint Joseph Mercy Livingston Hospital

620 Byron Road  
Howell, MI 48843  
Phone: 517-545-6000

## 3 Saint Joseph Mercy Woodland Health Center

7575 Grand River Road  
Brighton, MI 48114  
Phone: 810-844-7575

### Saint Joseph Mercy Woodland Cancer Center

7575 Grand River Road  
Brighton, MI 48114  
Phone: 810-844-7250

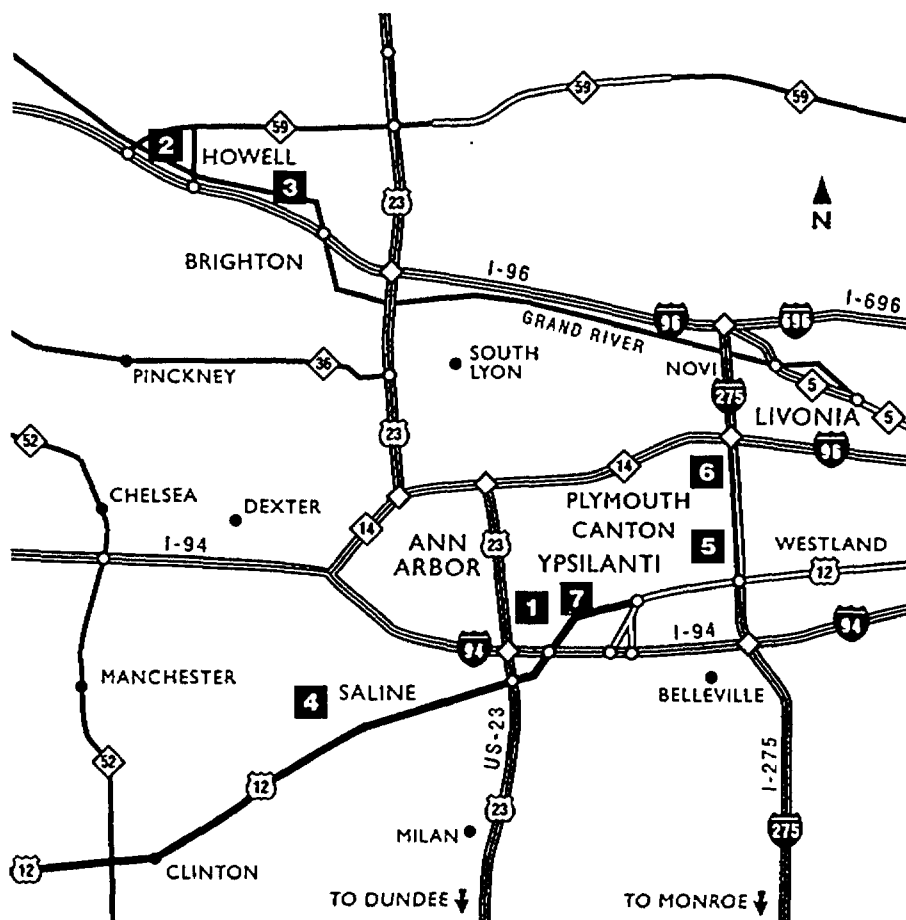

## 4 Saint Joseph Mercy Saline Hospital

400 Russell Street  
Saline, MI 48176  
Phone: 734-429-1500

## 5 Saint Joseph Mercy Canton Health Center

1600 S. Canton Center Road  
Canton, MI 48188  
Phone: 734-398-7557

## 6 Saint Joseph Mercy Arbor Health Center

990 W. Ann Arbor Trail  
Plymouth, MI 48170  
Phone: 734-414-1010

## 7 Saint Joseph Mercy Haab Health Building

111 N. Huron Street  
Ypsilanti, MI 48197

For information on physicians and community education classes, call the **Saint Joseph Mercy HealthLine** at 734-712-5400 or 800-231-2211, or visit our Web site at [www.sjmercyhealth.org](http://www.sjmercyhealth.org).

SEPTEMBER 10 - 16, 2006

# American Profile



## INSIDE:

- Welcome to Robin Rosaaen's house of Elvis
- Fairmount, Ind., James Dean's hometown
- Enlarging small rooms
- Fresh apple cake

## Your Opinion Matters!

Take our quick online reader survey at [www.AmericanProfileSurvey.com](http://www.AmericanProfileSurvey.com)

and **GET FREE SAMPLES AND SPECIAL OFFERS!**



**Wrangler**  
**JEANS CO**

ESTABLISHED 1947

OFFICIAL JEANS OF  
DALE EARNHARDT JR.



**NEW FITS. NEW COMFORT. NEW STYLES.**

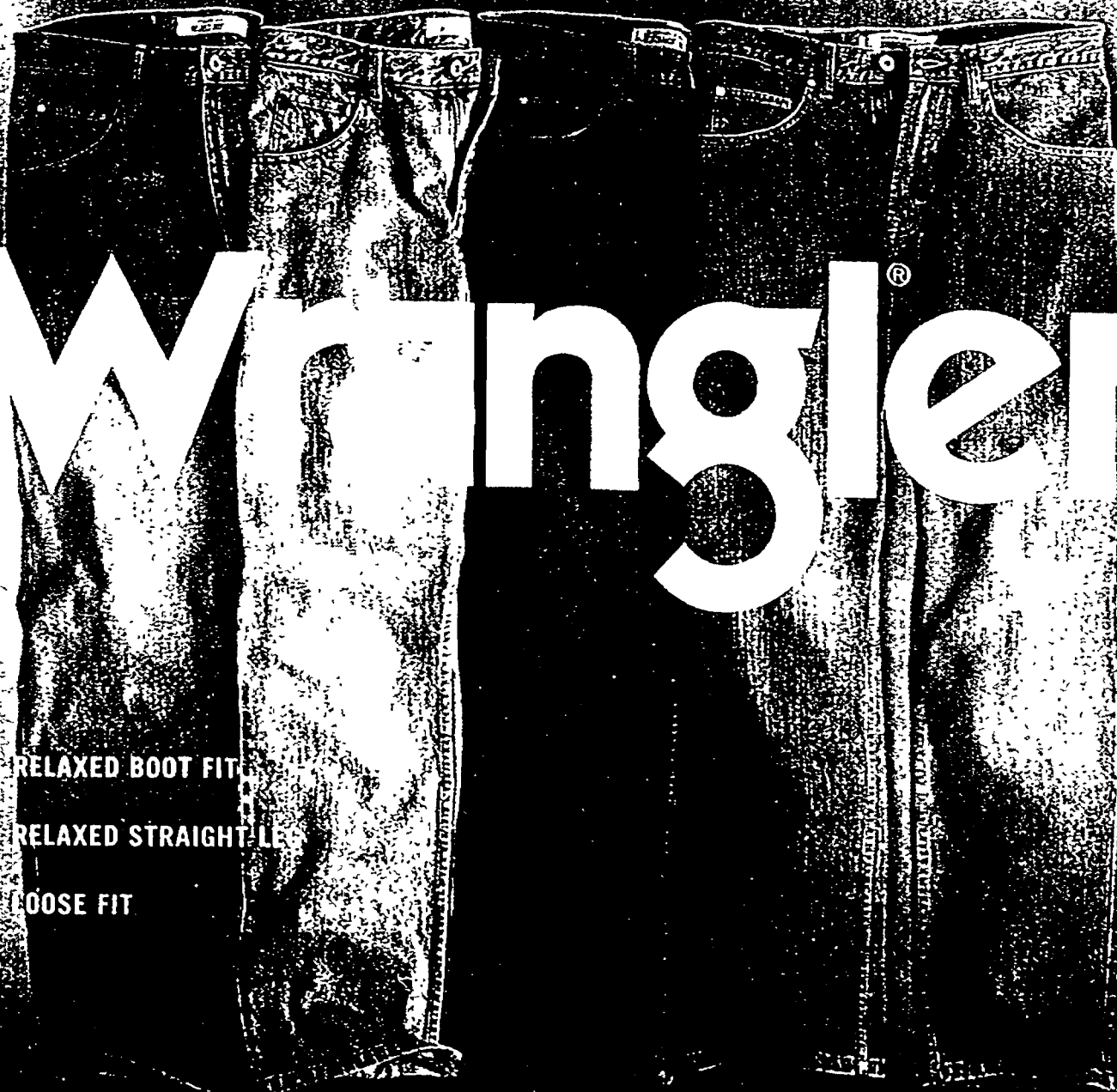

**Wrangler®**

RELAXED BOOT FIT

RELAXED STRAIGHT LEG

LOOSE FIT

**A NEW GENERATION OF WRANGLER**

CALL 1-888-784-8571 FOR A STORE NEAR YOU OR VISIT [WWW.WRANGLER.COM](http://WWW.WRANGLER.COM)

© 2000 VF Jeanswear, Inc.

The Dale Earnhardt Jr. (DEJ) name and other words, marks, slogans, and designs are trademarks, registered trademarks, or service marks of Dale Earnhardt, Inc. (DEI) and are being used by Wrangler Apparel Corp. under license from DEI.

# Ask American Profile

**Q** Bruce Jenner, the Olympic gold medalist, always seemed like such a decent, all-American guy. What's he doing nowadays?

—N. Sean, Magnolia, Ark.

Bruce Jenner won big in 1976.



Jenner, 56, recently appeared on TV's *Skating with Celebrities* with TV ice-partner Tai Babalonia. "I'm proud of what I did considering I had no experience and have an arthritic knee," says the 1976 Olympic decathlon winner. These days the father

of 10 children travels with his motivational-speaking presentation called "Finding the Champion Within." heads Bruce Jenner Aviation, an aircraft sales company, and is a spokesman for Euflexxa, a lubricant for arthritic knees.



Jenner today with wife Kris and daughters Kendall, left, and Kylie

**Q** Whatever happened to Fess Parker, the guy who played Davy Crockett?

—Liz McCormick, Las Vegas, Nev.

Parker portrayed the famous frontiersman only a handful of times, in several episodes of the Walt Disney-produced 1950s *Davy Crockett* TV mini-series, and later in a couple of movies. But it was enough to ignite a nationwide Crockett craze of coonskin caps, toy muskets and other spinoff merchandise. Parker also portrayed that other famous frontiersman, Daniel Boone, on the TV series of the same name from 1964 to 1970. Now 83 and retired from show business for nearly 30 years, he owns and operates the Fess Parker Winery and the Wine Country Inn and Spa in Los Olivos, Calif.



Retired actor Fess Parker

## CMT

### "CMT Sure Thing Fridays" Start the Weekend in Style

Kick off the weekend with "CMT Sure Thing Fridays" featuring *Trick My Truck*, now in its second season, at 7 p.m. Central and *Foxworthy's Big Night Out*, a new 12-episode series starring Jeff Foxworthy, at 7:30 p.m. Central. Let Truck's colorful Chrome Shop Mafia customizers and Foxworthy's parade of laughter and live music—from a variety of country-star guests—start your weekend in style!

**Q** I've been watching the new *Curious George* series with my children and noticed the narrator is William H. Macy. His voice sounds familiar—has he been in any movies or TV shows?

—Paige H., Corvallis, Ore.

Indeed, the talented Macy—who narrates the new daily PBS adventures of the "curious little monkey" who's thrilled kids since the first *Curious George* book was published in 1941—has appeared in more than 100 movies and TV series, including the films *Fargo*, *Seabiscuit*, *The Cooler* and *Magnolia*. The native Floridian is married to actress Felicity Huffman, who stars on TV's *Desperate Housewives*.



William H. Macy narrates the new *Curious George*.

**Q** What can you tell me about TV Judge Maria Lopez? I don't know anything about her, but she sure seems like she knows her stuff—and isn't afraid to say it!

—Sandy L., New Ulm, Minn.

Lopez, the outspoken real-life star of the new syndicated *Judge Maria Lopez* TV series, is a former Massachusetts Superior Court judge whose 14 years on the bench were sometimes controversial. (She resigned in 2003 after an outcry over her handling of a case in which she gave probation—instead of a harsher sentence—to a confessed child molester.) Her husband, Stephen Mindich, also is in the media spotlight as publisher of the *Boston Phoenix*, an alternative newspaper.

\* Cover photo by Jake Schoellkopf



Judge Maria Lopez

### Will You Marry Me?

People find all sorts of ways to propose marriage. How did you or your spouse pop the question? *American Profile* is seeking stories about unique, romantic and memorable marriage proposals for an upcoming story. If you've got an unforgettable story worthy of publication, mail a brief description of the event and a photograph of you and your spouse to: Marriage Proposals, *American Profile*, 341 Cool Springs Blvd. 4th Floor, Franklin, TN, 37067, by Oct. 15. Photographs will not be returned.

# American Profile

Celebrating Hometown Life

President & CEO  
Richard G. Porter  
Vice President/Group Publisher  
Tracey Atman  
Executive Editor  
Charles Cox  
Senior Editor, Staff Editor  
Editor Richard Mave  
Entertainment Editor Neil Ford  
Assistant Editor Jane Szyler  
Contributing Editors  
Marjorie Beverly, Kee, Mark W. Adair  
Art Director Brenna Sneed  
Publication Designer E.R. Elliott  
Photo Editor David Mudd  
Production Manager Sam Payne  
Traffic Coordinator Susan Fisher  
Manager of Internet Content Matt Johnson  
Web Developer Kevin Todd

## ADVERTISING SALES

1-800-766-2711  
Associate Publisher Amy Cramer  
NEW YORK  
Regional Ad Director Mary Brittain  
Account Managers Shannon May, Ken Gardner  
CHICAGO  
Midwest Ad Director Jeff Huber  
Account Manager Eric Schultz  
Southeast/West Coast Ad Director Frank Ze  
Los Angeles Account Manager Jim Reilly  
Director of Marketing Jeff Dunne  
Associate Director of Marketing Kevin H  
DIRECT RESPONSE ADVERTISING  
Advertising Director Linda Rich  
Account Manager Carl Macorato

## CIRCULATION SALES

Vice President/Publisher Relations  
Regional Circulation Directors  
Sue Park, Stephen Davis,  
Mike Gardner, Chris Kreuze  
Nashville 1-800-720-6320  
Director of Business Development  
Steve Mince

## CORPORATE & EDITORIAL OFFICES

Nashville 615-468-6000

## PUBLISHING GROUP OF AMERICA

President & CEO  
Richard G. Porter  
Chief Financial Officer & COO  
Stephen C. Duggan  
Vice President/Controller  
Ge. Cox  
Network Administrator Mark O  
www.americanprofile.com

## PUBLISHING GROUP OF AMERICA

*American Profile* is published by Publishing Group of America, 341 Cool Springs Blvd., Suite 400, Franklin, Tennessee 37067. Phone: 1-800-720-6320. Mail editorial queries and contributions to Editor, *American Profile*, 341 Cool Springs Blvd., Suite 400, Franklin, TN 37067. Publishing Group of America, Inc. will not be responsible for unsolicited materials, and cannot guarantee the return of any materials submitted to it. © 2006 Publishing Group of America, Inc. *American Profile* is a trademark of Publishing Group of America, Inc. All rights reserved. Reproduction in whole or part of any article, photograph or other portion of this magazine without the express written permission of Publishing Group of America, Inc. is prohibited.

# Hometown Recipes

from DIANE NEMITZ

## Fresh Apple Cake with Caramel Glaze

"I wanted the taste of caramel apples so I added a glaze to a recipe I had used before. It was a brilliant idea and I would never serve it plain again" ☆

### You Can Have 425 More Recipes Just Like This One!

The new *American Profile Hometown Cookbook* is loaded page after page with 425 crowd-pleasing, easy-to-prepare recipes from our nation's hometown kitchens. To order, send \$14.95 + \$4.95 s/h (\$19.90 total) to: American Profile Cookbook, 341 Cool Springs Blvd., Suite 400, Franklin, TN 37067 or call 1-800-851-5284

Residents of CA, TN, IL, AR and NY add sales tax NSF checks will be automatically debited for the amount of the check plus applicable fees Offer is limited

## RECIPE

### Fresh Apple Cake with Caramel Glaze



Photo: High Cotton Food Styling and Photography

### Fresh Apple Cake with Caramel Glaze

- Cake:**
- ¼ cup cinnamon-sugar mixture
  - 4 apples, chopped small
  - 3 eggs
  - 1 cup vegetable oil
  - 2 cups all-purpose flour
  - 2 cups sugar
  - ½ teaspoon baking soda
  - 1 teaspoon cinnamon

- Glaze:**
- 2 tablespoons butter
  - ½ cup firmly packed light brown sugar
  - 2 tablespoons milk

Preheat oven to 350F. Grease a Bundt or tube pan and coat with cinnamon-sugar mixture. Mix apples, eggs and oil with an electric mixer. Add flour, sugar, baking soda and cinnamon; mix well. Pour into pan and bake about 1 hour or until a toothpick inserted in center comes out clean. Allow cake to rest in pan for at least 10 minutes; invert onto a cake plate. To prepare glaze, combine butter, brown sugar and milk in a medium saucepan. Bring to a boil and cook for 1 minute. Spoon over cake. Allow to cool before serving.

#### Tips From Our Test Kitchen:

Serve with a dollop of whipped cream or scoop of vanilla ice cream. Nut lovers can add 1 cup of chopped walnuts or pecans to the cake batter.

American Profile



Diane Nemitz  
Lundington, Mich.

MANUFACTURER'S COUPON EXPIRES 12/09/06 NO DOUBLING



# 75¢ OFF

Any One Of The Below Listed RED BARON® Products



Consumer Coupon valid for 75¢ off the total purchase of any one package of RED BARON® Cheese, RED BARON® Thin Crust, THE BIG BARON®, or THE RED BARON® PIZZERIA STYLE pizza or RED BARON® DEEP DISH PAN STYLE pizza. Consumer may take this Retailer, Schwann's Consumer Brands from America, Inc. to receive you for the face value of this coupon plus 50¢. It is limited to one use per household. This coupon is not valid for cash back. For redemption must be shown and must be used by 12/09/06. Void if copied, altered, or otherwise. Mail Coupons to: Schwann's Consumer Brands from America, Inc., 12450 Old Forest Drive, Dallas, TX 75244. Limit one coupon per purchase.

© 2006 Schwann's Consumer Brands from America, Inc. All Rights Reserved.



5 72180 20075 9 (8100) 0 32091



# FILL YOUR FREEZER

Bring home the pizzas your whole family loves



© 2006 Schwann's Consumer Brands from America, Inc. All Rights Reserved

THE ONE FOR EVERYONE™



# "Enlarging" Small Rooms

by CAROL  
BOUSQUET  
CHOP

If you're tired of your home's small, crowded rooms, here are several decorating techniques to make them appear more spacious.

## Color and arrangement

You may have heard or read that light, cool colors always make spaces appear larger. That's a myth. The key to designing larger looking areas is to effectively employ two design concepts: color contrast and clever furniture arrangement. Here's how these techniques work.

## Little or no contrast

Matching window coverings, doors and trims to the wall color results in an immediate, spacious look. Blending large furniture pieces to the wall and/or floor colors also multiplies into a larger look. For example, a large recliner chair appears to take less space if its fabric blends into the backdrop. A backdrop includes the walls, windows and flooring treatments. If treated in solids or patterns that blend with each other, a more expansive look is created.

## One dominating color

A sense of order and a larger appearance is achieved when 80 to 90 percent of the colors and patterns in a room are closely related. Although this sounds a little boring, if accent colors are used for accessories, the results will give an eye-catching but visually larger impression. For example, if a king-size bedspread matches the flooring color, the bed "disappears," becoming part of the floor. This makes the area appear bigger.

## More solids, fewer patterns

Solid colors give a room a less busy, calm and more roomy appearance. Once the room is designed with mostly solid colors, add a few interesting patterns with art, photos and throw pillows.

## Arrange to lengthen or widen

Without sacrificing function, arrange long pieces of furniture to widen or lengthen a room. The ultimate room-size illusion technique is to install a floor-to-ceiling mirror on one wall. If that's too much, use a framed

mirror or other shiny finishes, such as trading a glass and brass coffee table for one made of wood.

## Get rid of junk

Rooms look larger if they're not crowded. Be sure the center of interest doesn't have highly noticeable or outstanding elements within the peripheral vision and allow plenty of eye-rests. Resist scattering bits and pieces around the room, such as too many florals or single wall hangings having no relationship with furnishings. The idea is to eliminate clutter and to strive for simplicity.

To lengthen the appearance of a room, place long pieces of furniture parallel to the length of the room and hang mirrors on the end wall. To make a room look shorter and wider, place the long pieces of furniture across the room's width. Enhance a fireplace as the center of interest with colorful accessories on the mantel.

## Be in charge

If you have to place furniture where it doesn't produce the desired effect, choose pertinent blending or contrasting. For example, if the sofa has to be placed on a long wall but you want the room to appear shorter, contrast the color to the wall or floor so it acts like a "stopping agent." Conversely, if a room has to have a sofa going across it but you don't want the space to appear wider, blend the sofa with the flooring color to minimize widening illusions.

## Plan ahead

Before buying new furniture, experiment with arrangements and looks by using furniture on hand to stimulate ideas and to get a better sense of available space. Move it around and look it over. Remember, experimenting with design concepts before buying gives confidence—while saving time, money and worry. ☆

*Carol Bousquet Chop applies design techniques to her home in Florida.*

## Rate This Story

How did you like this story? Log on to  
[www.americanprofile.com/rate](http://www.americanprofile.com/rate)



Photo: Media Bakery

Trees  
Dramatically  
Different

This is celebrate our 17th year on the 11th  
Extra 10%  
Bonus Discount  
Until Sept. 20  
Enter code AP41  
when checking  
out

The World's Finest Artificial Christmas Trees

A Story of Quality & Value  
**TREE CLASSICS**

Pre-Lit Trees, Wreaths, Garland, Tree Skirts, Stockings

[WWW.TREECLASSICS.COM](http://WWW.TREECLASSICS.COM)

Barrington IL • Phone 847 834 2961 • Email [info@treeclassics.com](mailto:info@treeclassics.com)

68 styles  
4 1/2' 40 tall  
5 year light warranty  
10 year tree warranty  
100% satisfaction guarantee  
Factory Direct  
Save 40% 60%

Always  
Free  
Shipping

Hinged  
branches  
Trees set up in  
minutes

# Jericho's Hometown Heroes

*When chaos ensues, who will save the residents?*



## Jericho

When a nuclear mushroom cloud suddenly appears on the horizon, fear of the unknown sends the residents of this small Kansas town into a chaotic state. Could they be the only Americans left alive?

When all communication and power is shut down, terror, anger and confusion reigns. Mayor Johnston is called to action, giving him no time to deal with the surprise return of his estranged son, Jake, who becomes an unlikely hero in the face of all of this destruction.

Many of Jericho's residents, including elementary school teacher Heather Lipinski; Robert Hawkins, a mysterious newcomer; and Dale Turner, a 16-year-old trailer park kid – will be forced to find an inner strength they never knew they had.

**Jericho Premieres Wednesday, September 20, 2006**

## **Jericho Mayor, Johnston Green**

Mayor Green's strong sense of community remains focused even under the most adverse conditions. When Jericho is hit with the unimaginable, Green's mettle remains solid as he works to calm and protect his scared and confused constituents. With an uncertain future, Jericho will lean heavily on their elected leader.



## **Jake Green**

Mayor Green's son, Jake, has collected life experiences that belie his young age. While his relationship with his father has been far from perfect, his recent return to Jericho – at a time when the town is being turned upside down – casts him into the unlikely role of hero. His bravery and quick call to action will have lasting effects on the residents of his hometown.



TODAY IS THE LAST  
ORDINARY DAY

# JERICHO

PREMIERES WED SEPT 20 8/7c CBS



CBS

# Planning a Multi-Generational Trip

by MARY DIXON LEBEAU

Taking a trip with three generations of family is the latest travel trend, according to the Travel Industry Association. Just ask Dearborn, Mich., resident Donna R. Braden, who planned a long weekend away with her family—husband Curt, their 15-year-old daughter, Caroline, and Donna's 70-year-old mother, Elaine Rosenstein—to a retreat along Lake Michigan.

"We had made a long list of possible things to do, but only ended up doing a few of them," Donna Braden says. "Mom didn't like sun or bugs and had a whole different concept of schedule."

So to make their multi-generational vacation a success, the Bradens had to rethink their priorities and adjust their plans.

"The most important lesson I learned that weekend is that the best times were just when we were sitting around talking or taking informal walks," Braden says. "The being together was much more important than the doing something."



The "being together" is why an increasing number of families are choosing to make their vacations multi-generational, with kids, parents, grandparents and even great-grandparents. "It's an opportunity for tremendous bonding," says Marlene Coleman, author of *Safe and Sound: Healthy Travel With Children*. "Traveling together gives you a chance to get to know the various members of your family on a deeper level."

Planning is crucial to the success of a multi-generational vacation and, as the Bradens learned, it's important to get input from all members of your party before you hit the road. "Involve everybody in the planning stage," Coleman says. "That way you'll know what everyone's expectations and abilities are."

"First, consider the age and the health of the people who will be going on the trip," Coleman says. "That way, you can choose a destination and activities that will be appropriate for everyone."

Also consider any special needs your family requires. "Older grandparents may require the assistance of electric vehicles or wheelchairs, or even medical assistance. Listening devices and other similar services may be needed," says Laura Miller, the director of Travel Insights Group and

author of *Fronner's Walt Disney World and Orlando with Kids 2006-2007*.

On the other end of the spectrum, young children may require strollers, car seats or time for a nap. "All special needs should be carefully considered," Miller says. "Some hotels and resorts will cater more to those needs than others."

Also consider everyone's financial means when choosing a location. You don't want to cause resentment or even embarrassment if one of the activities planned is beyond someone's budget, so agree on expenditures before you leave home.

Your itinerary should include activities for everyone, but remember not all family members have to participate in everything. Get "must do" choices from every traveler in your party, then create an itinerary together around these selections.

With some planning, you'll develop an itinerary everyone is happy with—but remember it isn't written in stone. Scheduling glitches happen a lot, so be open to alternative options during your stay. If grandmother decides to spend more time sightseeing or if the baby takes a longer nap than scheduled, it will be OK. Remember the important thing about this trip is enjoying each

other, not sticking to a laid-out plan.

Just as important as your time together, is getting some time apart. "Separate time is crucial," Miller says. "No matter how well everyone is getting along, it is impossible to agree on absolutely everything. Take a break from each other and you'll be far happier for it."

But always remember that the focus of the trip is spending time with each other—even if it's just in the hotel room or around a table at mealtime. The magic of a multi-generational vacation isn't the places you go or the activities you participate in. It's found in the people you share that time with—and the irreplaceable memories you'll make together ☆

Mary Dixon Lebeau is a frequent contributor to American Profile.

**Rate This Story**  
How did you like this story? Log on to [www.americanprofile.com/rate](http://www.americanprofile.com/rate).

OH, I WISH...  
I COULD eat THIS RIGHT  
off THE PAGE.



**DELI SHAVED SALAMI.**  
For thinly sliced, deli fresh taste,  
**YOU CAN COUNT ON OSCAR®.**

[www.oscarmayer.com](http://www.oscarmayer.com)



## Cover Story

by BEVERLY KEEL  
Contributing Editor

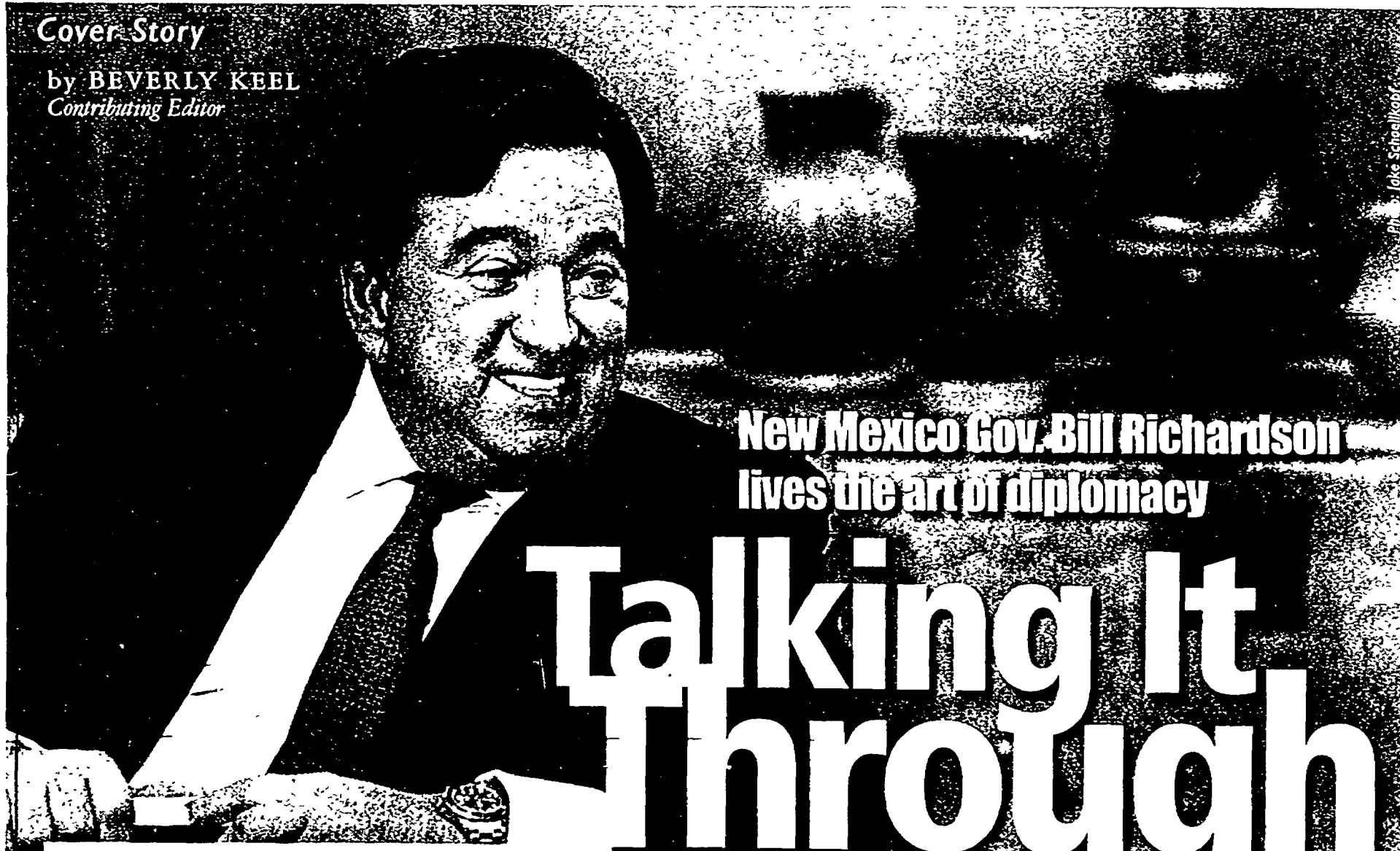

New Mexico Gov. Bill Richardson  
lives the art of diplomacy

# Talking It Through

## New Mexico Gov. Bill Richardson

bridges two cultures at a time when the nation is buzzing about illegal immigration. "You have to recognize that it's a very divisive issue in America and you have to approach it only in a bipartisan manner," explains Richardson, 59, the son of an American businessman and his Mexican wife.

"These people wanting to come in just want a better life for their families," he says. "They are not bandits or terrorists, they want a better life." But, he says, their desire must be balanced with the priority of protecting the jobs and safety of Americans.

Richardson's level-headed position on immigration is indicative of his long-held philosophy of leadership in general: Listen to all sides of an issue, negotiate and, when possible, forge a compromise that is a win for both sides.

"He is on a very short list of about five officials nationally known in a position to have an impact on this issue," says Ruben Navarrette Jr., a nationally syndicated newspaper columnist. "When Bill Richardson speaks on the immigration issue, people ought to listen. He is important to the debate."

A political maverick with an admitted temper, Richardson, 59, has made waves sometimes with his independent streak and unorthodox approach. "He is a Democrat who is not afraid to praise a Republican," Navarrette says. Richardson—who last year made *TIME* magazine's list of 25 most



"I try to be a mainstream American politician enormously proud of my Hispanic heritage," says Gov. Richardson.

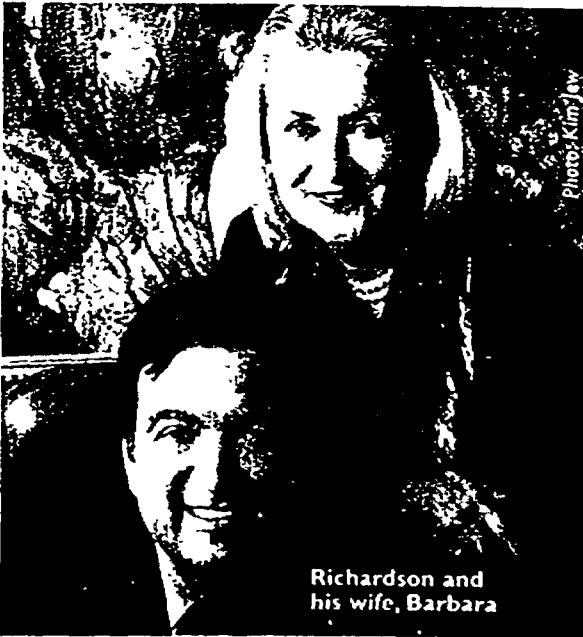

Richardson and  
his wife, Barbara

"He's bicultural, and that gives him an insight into dealing with people, especially in tough situations."

—Barbara Richardson

influential Hispanics in America—also is known to be gregarious, charismatic, informal and quick to make a joke to diffuse a tense situation, a skill that he often has used in conducting sensitive negotiations around the world on behalf of the United States.

## America's 'go-to' guy

With a resume that includes seven terms in Congress and stints as U.S. ambassador to the United Nations and the U.S. Secretary of Energy, the four-time Nobel Peace Prize nominee often was the nation's go-to guy when delicate negotiations with Iraq, Cuba, Sudan and North Korea required face-to-face encounters. Although Richardson insists that he is focusing on his November re-election as governor, he has been touted as a possible presidential candidate in 2008.

Should I be re-elected (as governor, on Nov. 7), I want my constituents in New Mexico to be comfortable with whether I run for president," he says. "I've got to make an assessment: Is it worth the intensity and scrutiny and hard work that it's going to take? I'm ready for the hard work and scrutiny, but it's not a final decision. I'm a big believer in luck and faith, and I don't know what God has in store."



In 1962, Richardson (seated, second from left) played high school baseball in Concord, Mass.



Richardson, meeting with Kim Sanchez-Rael from his board of finance, has been touted as a possible presidential candidate.

*TIME* magazine senior writer Joe Klein says it is too early to determine what sort of presidential candidate Richardson would be. "He is a very personable guy; he has a lot of foreign experience," Klein says. "We'll see whether he can summon the kind of seriousness and gravitas necessary for president."

Born in Pasadena, Calif., raised in Mexico City and educated at a Massachusetts prep school, Richardson has spent his entire life existing between two cultures. His father spoke to him in English, while his mother addressed him in Spanish. He spent his afternoons on Mexico City baseball fields in good-natured competition alongside some of the poorest children in the city before moving to Concord, Mass., at age 12 and joining his wealthy classmates on the Middlesex School baseball team. He earned a master's degree in international affairs at Boston's Tufts University in the early 1970s.

"He's bicultural, and that gives him an insight into dealing with people, especially in tough situations," says his wife, Barbara. "If you can't do it one way, let's look at another way to achieve a goal. He points out that you have to walk in that person's shoes and know what it is that person needs when you are in negotiations."

## Between worlds

Richardson's cultural duality had a downside as well. "Neither side accepted me," says Richardson, who describes his experiences in the 2005 book, *Between Worlds: The Making of an American Life*. "Man, I had a comfortable life, and I'm not complaining. But at the same time, Mexicans didn't accept me because I had this Anglo name, and when I went to school in the United States, the Americans called me Pancho and I didn't quite fit in and I didn't relate to anything."

His mixed ethnicity helped Richardson develop a strong sense of self, a passion for fairness and a drive to help those who don't have a voice in any language. It taught him that almost every dispute can be talked through—it's always worse not to talk, he says—and that

he can find something in common with almost everyone. He used a common love of baseball as an icebreaker with Cuban leader Fidel Castro in 1996.

In other high-level diplomatic negotiations around the globe, Richardson says he often sensed that, across the table, "they liked the fact that I was a minority and that I could relate to another culture," he says. "It gave me an advantage because they thought, 'He's an American, but he's got other cultures and we think he's able to relate better to us.'"

But he stresses that he is an American first, albeit one who cherishes his Hispanic heritage. "I don't want to be known as a professional Hispanic, that everything I do is because I'm Hispanic or I only serve Hispanics," says Richardson, who says he dreams in English but reverts to speaking Spanish after periodic vacations in Mexico. "I serve a broad constituency: Native Americans, Anglos, Hispanics, progressives, Republicans. I don't compromise my values, but I never liked to highlight my Hispanic-ness."

His political advisers once suggested that he use the name Bill Richardson-Lopez because his mother's maiden name is Lopez. "I said, 'That's not me.'"

(Continued on page 17)

If our ad  
in this magazine  
doesn't tell you  
what you want  
to know about  
**CRESTOR**,  
turn to  
our Web site.

At CRESTOR.com  
you will also find tools, tips,  
and important questions to  
ask your doctor or pharmacist.

**CRESTOR.com**

CRESTOR is a registered trademark of AstraZeneca  
© 2003 AstraZeneca Pharmaceuticals LP  
AstraZeneca, Inc. 228171 01/03

  
**CRESTOR**<sup>®</sup>  
rosuvastatin calcium

AstraZeneca 

## Hometown Spotlight

# Hometown with a Cause

by ALANNA NASH

A statue of the late actor James Dean welcomes visitors to a gift shop and museum in his hometown of Fairmount, Ind.

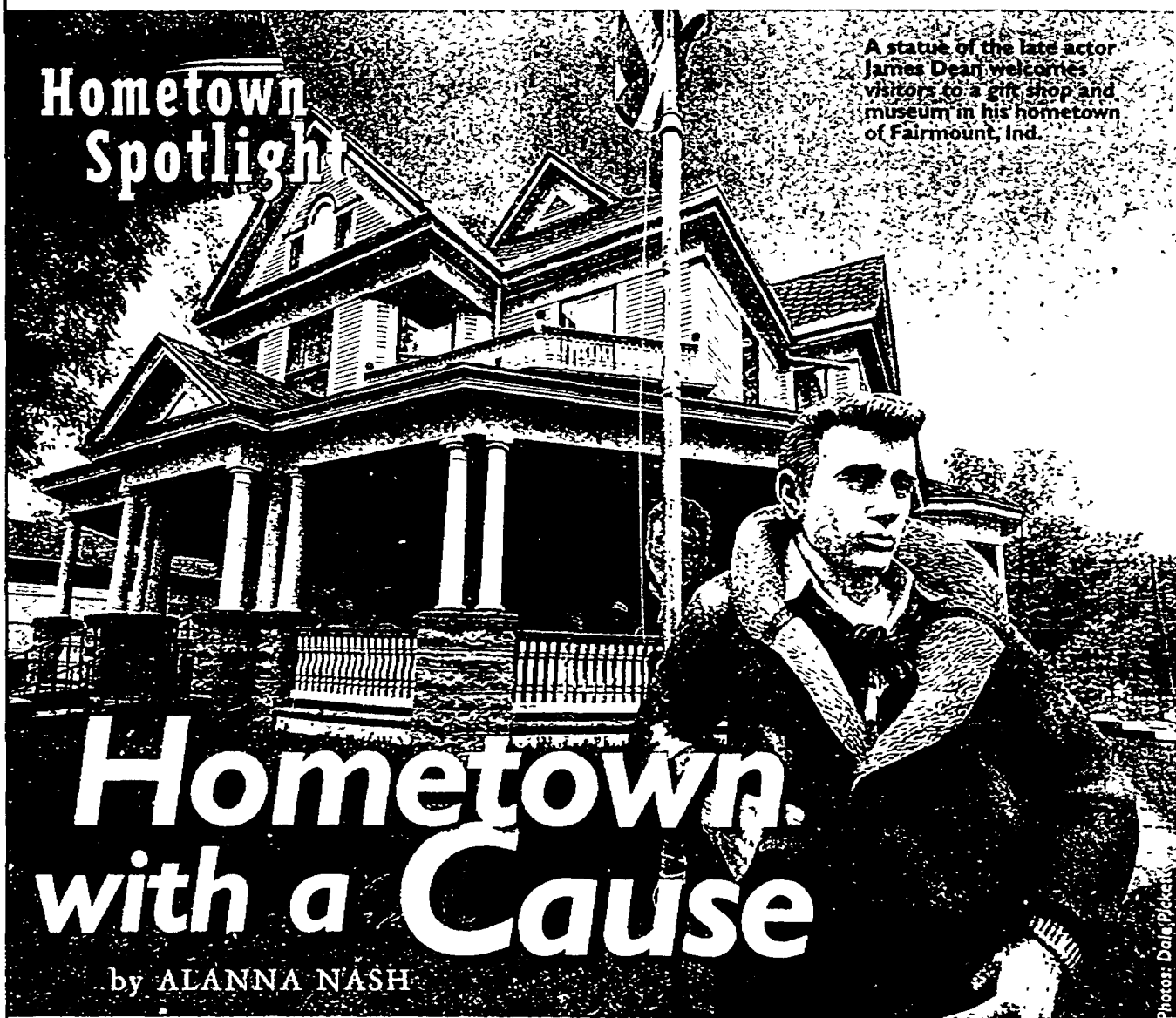

Fairmount, Ind. (pop. 2,992), boasts more than its fair share of famous former residents, including *Garfield* creator Jim Davis, CBS national news commentator Phil Jones and Robert C. Sheets, director of the National Hurricane Service.

But none of them influenced popular culture like actor James Dean, who starred in film classics such as *East of Eden*, *Rebel Without a Cause* and *Grant*, then died at age 24 in a California car crash nearly 51 years ago, on Sept. 30, 1955. At the time of his death, he'd been pegged as a Hollywood leading man in-the-making; afterward, he ascended to the status of a live-fast, die-young American icon—a "rebel" on a motorcycle, or in a hot rod convertible, headed toward the horizon and setting his own course.

Each year, Dean's hometown honors his legacy with the Fairmount Museum Days Remembering James Dean festival, sponsored by the Fairmount Historical Museum. On Sept. 21-24, nearly 50,000 fans are expected to swell the streets of the Hoosier town where Dean spent his formative years, though he actually was born in Marion, Ind.

Fairmount has

A license plate for life in the fast lane!



## JAMES DEAN GALLERY

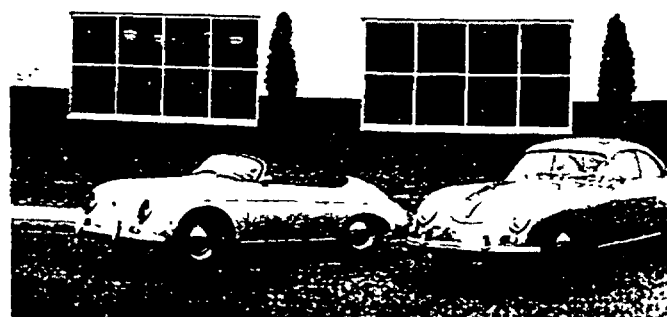

Festival-goers often bring their own classic restored cars—such as the Porsche Spyder convertible like Dean drove.

grown—slightly—in the years since Dean walked its streets. It now boasts a "Giant" bar (festooned with a mural of Dean), as well as a supermarket, two gas stations, two banks and a laundromat. But the town is mostly unchanged from the days when photographer Dennis Stock took his now-famous pictures of a brooding Dean at home in Indiana. And fans wouldn't have it any other way.

"I think it amazes most of us that (fans) do come each year, that this has lasted," says Melba Root, president of the Fairmount Town Council. "And a lot of them come back because they just like this regular, little, early American town."

They also like to pore over the Dean exhibit at the museum, which is the world's largest reposit-

tory of the actor's personal belongings, including his motorcycles, boots, bongo drum, letters to his family, and several pieces of Dean's artwork as both a student at Fairmount High School (class of 1949) and shortly before his death.

Museum president Gale Hikade says the actor probably wouldn't know what to make of the festivities in his name. "I think he'd have a big grin on, just put his head down and shake it the way he did in the movies when he didn't have anything to say but still wanted to say something," Hikade says. "I think he'd get a big bang out of it."

Chances are, the actor also would get a kick out of fans who enter the James Dean look-alike contests (one for kids, another for adults), watch the James Dean Rod Run of vintage cars, attend a memorial service at the Back Creek Friends Meeting Quaker church that Dean attended as a boy, and

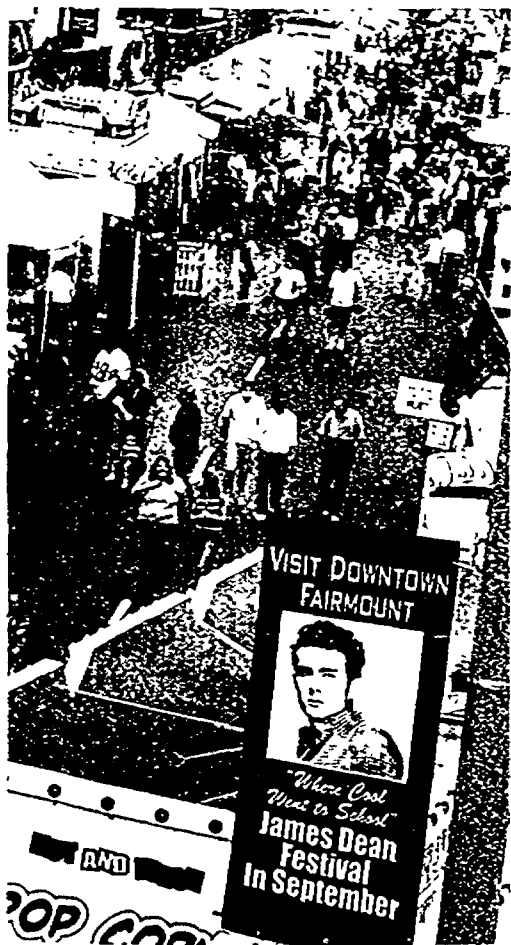

Fans flock to Fairmount each September.

visit his grave at Park Cemetery outside of town, where hyper-zealous pilgrims—known as "Deaners" by local police—have stolen his pink granite tombstone three times. Often, luminaries such as actor Martin Sheen or singer-songwriter Rufus Wainwright attend.

Phil Zeigler first came to Fairmount to pay homage to his hero in 1977. He is now 75, the same age Dean would be had he lived. A city dweller all his life, Zeigler was so struck by

(Continued on page 14)

THINK YOU KNOW ALL THERE IS ABOUT GETTING YOUR CHOLESTEROL RIGHT?

## Get this FREE Info Kit—then talk to your doctor!

### Getting high cholesterol down is important.

And for some people, it's even more important. In fact, a panel of medical experts proposed updated guidelines suggesting many patients aim for an even lower cholesterol goal than before.\*

### A tool that helps you talk the talk.

Your kit contains a "Talk It Up!" conversation guide—designed to help you make the most of the time you have with your doctor. An accompanying brochure explains why managing *both* your "bad" and "good" cholesterol can be important.

### CRESTOR—for *both* your "bad" and "good" cholesterol.

If you haven't reached your cholesterol goal with diet and exercise alone, CRESTOR® (rosuvastatin calcium) may make the difference you need. Your results may vary. To learn more about CRESTOR and managing your cholesterol—call for your free kit *today!*

### Important Safety Information



**Terms and Conditions:** Limit one 15-day free trial certificate per person for the duration of the offer. Valid ONLY at retail pharmacies; no mail order. Please see patient eligibility restrictions and other terms and conditions on the back of this certificate.

RxBIN # 003858      RxCN # A4      RxGRP # DSWA      Identification # 1296272352

This offer is good through 12/8/06.

## TRY CRESTOR FREE FOR YOUR FIRST 15 DAYS

Redeem this offer right now:

- 1 Take this voucher to your doctor and ask whether CRESTOR is right for you.
- 2 If your doctor prescribes CRESTOR 5 mg or 10 mg, present both this voucher and your prescription to your pharmacist.

Call 877-548-8599 or visit CRESTOR.com for answers to commonly asked questions about CRESTOR.

**CRESTOR**  
rosuvastatin calcium

AstraZeneca



Please read this summary carefully and then ask your doctor about CRESTOR. No advertisement can provide all the information needed to determine if a drug is right for you. This advertisement does not take the place of careful discussions with your doctor. Only your doctor has the training to weigh the risks and benefits of a prescription drug.

**BRIEF SUMMARY:** CRESTOR is indicated for the treatment of hypercholesterolemia. **INDICATIONS AND USAGE:** CRESTOR is indicated for the treatment of hypercholesterolemia in patients with hypercholesterolemia and/or hypertriglyceridemia. **CONTRAINDICATIONS:** CRESTOR is contraindicated in patients with active liver disease or unexplained persistent elevations of serum transaminases. **Pregnancy and Lactation:** Use of CRESTOR during pregnancy is not recommended. **Warnings:** CRESTOR may cause myopathy and rhabdomyolysis. **Precautions:** CRESTOR may cause myopathy and rhabdomyolysis. **Adverse Reactions:** Common adverse reactions include headache, dizziness, and constipation. **Drug Interactions:** CRESTOR may interact with other medications. **How Supplied:** CRESTOR is available in 10 mg and 20 mg tablets. **US Patents:** CRESTOR is covered by several US patents.

**INDICATIONS AND USAGE:** CRESTOR is indicated for the treatment of hypercholesterolemia in patients with hypercholesterolemia and/or hypertriglyceridemia. CRESTOR is contraindicated in patients with active liver disease or unexplained persistent elevations of serum transaminases. Use of CRESTOR during pregnancy is not recommended. CRESTOR may cause myopathy and rhabdomyolysis. CRESTOR may cause myopathy and rhabdomyolysis. Common adverse reactions include headache, dizziness, and constipation. CRESTOR may interact with other medications. CRESTOR is available in 10 mg and 20 mg tablets. CRESTOR is covered by several US patents.

**INDICATIONS AND USAGE:** CRESTOR is indicated for the treatment of hypercholesterolemia in patients with hypercholesterolemia and/or hypertriglyceridemia. CRESTOR is contraindicated in patients with active liver disease or unexplained persistent elevations of serum transaminases. Use of CRESTOR during pregnancy is not recommended. CRESTOR may cause myopathy and rhabdomyolysis. CRESTOR may cause myopathy and rhabdomyolysis. Common adverse reactions include headache, dizziness, and constipation. CRESTOR may interact with other medications. CRESTOR is available in 10 mg and 20 mg tablets. CRESTOR is covered by several US patents.

**INDICATIONS AND USAGE:** CRESTOR is indicated for the treatment of hypercholesterolemia in patients with hypercholesterolemia and/or hypertriglyceridemia. CRESTOR is contraindicated in patients with active liver disease or unexplained persistent elevations of serum transaminases. Use of CRESTOR during pregnancy is not recommended. CRESTOR may cause myopathy and rhabdomyolysis. CRESTOR may cause myopathy and rhabdomyolysis. Common adverse reactions include headache, dizziness, and constipation. CRESTOR may interact with other medications. CRESTOR is available in 10 mg and 20 mg tablets. CRESTOR is covered by several US patents.

**INDICATIONS AND USAGE:** CRESTOR is indicated for the treatment of hypercholesterolemia in patients with hypercholesterolemia and/or hypertriglyceridemia. CRESTOR is contraindicated in patients with active liver disease or unexplained persistent elevations of serum transaminases. Use of CRESTOR during pregnancy is not recommended. CRESTOR may cause myopathy and rhabdomyolysis. CRESTOR may cause myopathy and rhabdomyolysis. Common adverse reactions include headache, dizziness, and constipation. CRESTOR may interact with other medications. CRESTOR is available in 10 mg and 20 mg tablets. CRESTOR is covered by several US patents.

**INDICATIONS AND USAGE:** CRESTOR is indicated for the treatment of hypercholesterolemia in patients with hypercholesterolemia and/or hypertriglyceridemia. CRESTOR is contraindicated in patients with active liver disease or unexplained persistent elevations of serum transaminases. Use of CRESTOR during pregnancy is not recommended. CRESTOR may cause myopathy and rhabdomyolysis. CRESTOR may cause myopathy and rhabdomyolysis. Common adverse reactions include headache, dizziness, and constipation. CRESTOR may interact with other medications. CRESTOR is available in 10 mg and 20 mg tablets. CRESTOR is covered by several US patents.



**INDICATIONS AND USAGE:** CRESTOR is indicated for the treatment of hypercholesterolemia in patients with hypercholesterolemia and/or hypertriglyceridemia. CRESTOR is contraindicated in patients with active liver disease or unexplained persistent elevations of serum transaminases. Use of CRESTOR during pregnancy is not recommended. CRESTOR may cause myopathy and rhabdomyolysis. CRESTOR may cause myopathy and rhabdomyolysis. Common adverse reactions include headache, dizziness, and constipation. CRESTOR may interact with other medications. CRESTOR is available in 10 mg and 20 mg tablets. CRESTOR is covered by several US patents.

**INDICATIONS AND USAGE:** CRESTOR is indicated for the treatment of hypercholesterolemia in patients with hypercholesterolemia and/or hypertriglyceridemia. CRESTOR is contraindicated in patients with active liver disease or unexplained persistent elevations of serum transaminases. Use of CRESTOR during pregnancy is not recommended. CRESTOR may cause myopathy and rhabdomyolysis. CRESTOR may cause myopathy and rhabdomyolysis. Common adverse reactions include headache, dizziness, and constipation. CRESTOR may interact with other medications. CRESTOR is available in 10 mg and 20 mg tablets. CRESTOR is covered by several US patents.

**INDICATIONS AND USAGE:** CRESTOR is indicated for the treatment of hypercholesterolemia in patients with hypercholesterolemia and/or hypertriglyceridemia. CRESTOR is contraindicated in patients with active liver disease or unexplained persistent elevations of serum transaminases. Use of CRESTOR during pregnancy is not recommended. CRESTOR may cause myopathy and rhabdomyolysis. CRESTOR may cause myopathy and rhabdomyolysis. Common adverse reactions include headache, dizziness, and constipation. CRESTOR may interact with other medications. CRESTOR is available in 10 mg and 20 mg tablets. CRESTOR is covered by several US patents.

**Table 1. Adverse Events in Placebo-Controlled Studies**

Adverse Event	Ros 10 mg (n=152)	Placebo (n=152)
Headache	12.5	11.8
Dizziness	10.5	10.5
Constipation	9.2	9.2
Nausea	8.6	8.6
Diarrhea	7.9	7.9
Flatulence	7.3	7.3
Abdominal pain	6.6	6.6
Stomach pain	6.0	6.0
Upper respiratory tract infection	5.3	5.3
Back pain	4.7	4.7
Joint pain	4.1	4.1
Joint swelling	3.5	3.5
Joint stiffness	2.9	2.9
Joint tenderness	2.3	2.3
Joint pain/swelling	1.7	1.7
Joint tenderness/swelling	1.1	1.1
Joint pain/swelling/tenderness	0.5	0.5

**INDICATIONS AND USAGE:** CRESTOR is indicated for the treatment of hypercholesterolemia in patients with hypercholesterolemia and/or hypertriglyceridemia. CRESTOR is contraindicated in patients with active liver disease or unexplained persistent elevations of serum transaminases. Use of CRESTOR during pregnancy is not recommended. CRESTOR may cause myopathy and rhabdomyolysis. CRESTOR may cause myopathy and rhabdomyolysis. Common adverse reactions include headache, dizziness, and constipation. CRESTOR may interact with other medications. CRESTOR is available in 10 mg and 20 mg tablets. CRESTOR is covered by several US patents.

**INDICATIONS AND USAGE:** CRESTOR is indicated for the treatment of hypercholesterolemia in patients with hypercholesterolemia and/or hypertriglyceridemia. CRESTOR is contraindicated in patients with active liver disease or unexplained persistent elevations of serum transaminases. Use of CRESTOR during pregnancy is not recommended. CRESTOR may cause myopathy and rhabdomyolysis. CRESTOR may cause myopathy and rhabdomyolysis. Common adverse reactions include headache, dizziness, and constipation. CRESTOR may interact with other medications. CRESTOR is available in 10 mg and 20 mg tablets. CRESTOR is covered by several US patents.

**INDICATIONS AND USAGE:** CRESTOR is indicated for the treatment of hypercholesterolemia in patients with hypercholesterolemia and/or hypertriglyceridemia. CRESTOR is contraindicated in patients with active liver disease or unexplained persistent elevations of serum transaminases. Use of CRESTOR during pregnancy is not recommended. CRESTOR may cause myopathy and rhabdomyolysis. CRESTOR may cause myopathy and rhabdomyolysis. Common adverse reactions include headache, dizziness, and constipation. CRESTOR may interact with other medications. CRESTOR is available in 10 mg and 20 mg tablets. CRESTOR is covered by several US patents.

**INDICATIONS AND USAGE:** CRESTOR is indicated for the treatment of hypercholesterolemia in patients with hypercholesterolemia and/or hypertriglyceridemia. CRESTOR is contraindicated in patients with active liver disease or unexplained persistent elevations of serum transaminases. Use of CRESTOR during pregnancy is not recommended. CRESTOR may cause myopathy and rhabdomyolysis. CRESTOR may cause myopathy and rhabdomyolysis. Common adverse reactions include headache, dizziness, and constipation. CRESTOR may interact with other medications. CRESTOR is available in 10 mg and 20 mg tablets. CRESTOR is covered by several US patents.

**INDICATIONS AND USAGE:** CRESTOR is indicated for the treatment of hypercholesterolemia in patients with hypercholesterolemia and/or hypertriglyceridemia. CRESTOR is contraindicated in patients with active liver disease or unexplained persistent elevations of serum transaminases. Use of CRESTOR during pregnancy is not recommended. CRESTOR may cause myopathy and rhabdomyolysis. CRESTOR may cause myopathy and rhabdomyolysis. Common adverse reactions include headache, dizziness, and constipation. CRESTOR may interact with other medications. CRESTOR is available in 10 mg and 20 mg tablets. CRESTOR is covered by several US patents.

**INDICATIONS AND USAGE:** CRESTOR is indicated for the treatment of hypercholesterolemia in patients with hypercholesterolemia and/or hypertriglyceridemia. CRESTOR is contraindicated in patients with active liver disease or unexplained persistent elevations of serum transaminases. Use of CRESTOR during pregnancy is not recommended. CRESTOR may cause myopathy and rhabdomyolysis. CRESTOR may cause myopathy and rhabdomyolysis. Common adverse reactions include headache, dizziness, and constipation. CRESTOR may interact with other medications. CRESTOR is available in 10 mg and 20 mg tablets. CRESTOR is covered by several US patents.

**INDICATIONS AND USAGE:** CRESTOR is indicated for the treatment of hypercholesterolemia in patients with hypercholesterolemia and/or hypertriglyceridemia. CRESTOR is contraindicated in patients with active liver disease or unexplained persistent elevations of serum transaminases. Use of CRESTOR during pregnancy is not recommended. CRESTOR may cause myopathy and rhabdomyolysis. CRESTOR may cause myopathy and rhabdomyolysis. Common adverse reactions include headache, dizziness, and constipation. CRESTOR may interact with other medications. CRESTOR is available in 10 mg and 20 mg tablets. CRESTOR is covered by several US patents.

**INDICATIONS AND USAGE:** CRESTOR is indicated for the treatment of hypercholesterolemia in patients with hypercholesterolemia and/or hypertriglyceridemia. CRESTOR is contraindicated in patients with active liver disease or unexplained persistent elevations of serum transaminases. Use of CRESTOR during pregnancy is not recommended. CRESTOR may cause myopathy and rhabdomyolysis. CRESTOR may cause myopathy and rhabdomyolysis. Common adverse reactions include headache, dizziness, and constipation. CRESTOR may interact with other medications. CRESTOR is available in 10 mg and 20 mg tablets. CRESTOR is covered by several US patents.

**INDICATIONS AND USAGE:** CRESTOR is indicated for the treatment of hypercholesterolemia in patients with hypercholesterolemia and/or hypertriglyceridemia. CRESTOR is contraindicated in patients with active liver disease or unexplained persistent elevations of serum transaminases. Use of CRESTOR during pregnancy is not recommended. CRESTOR may cause myopathy and rhabdomyolysis. CRESTOR may cause myopathy and rhabdomyolysis. Common adverse reactions include headache, dizziness, and constipation. CRESTOR may interact with other medications. CRESTOR is available in 10 mg and 20 mg tablets. CRESTOR is covered by several US patents.



A bronze bust of James Dean is part of a display of his movie-career memorabilia.

*(Continued from page 13)*  
Fairmount's quiet, laid-back atmosphere and friendly people that he began visiting each year beginning in 1983. In 1996, he moved to Fairmount after retiring as an optometrist in York, Pa. Today, Zeigler lives in the house once occupied by Dean's father next to the family farm north of town in Jonesboro (pop. 1,887). He earned that privilege by striking up a friendship with Dean's first cousin, Marcus Winslow Jr., who grew up with the film star-to-be.

"I told him when I retired I wanted to move out here, and he said, 'Well, we'll see if we can't find a place for you,'" Zeigler recalls. Now he helps Winslow and members of the museum staff organize the town's annual events in memory of its most famous citizen.

"I think it will go on forever," Root says. As long as there are movies and people who love them, she says, "they'll come. And we'll be glad to see 'em."

Alanna Nash, a contributor to American Profile, lives in Louisville, Ky.

Visit [www.jamesdeanartifacts.com](http://www.jamesdeanartifacts.com) for more information.



Alex Beachy, 12, from Nappanee, Ind., soaks up the sights in the James Dean museum.

**Rate This Story**  
How did you like this story? Log on to [www.americanprofile.com/rate](http://www.americanprofile.com/rate)



Cut your cholesterol ... with cantaloupe!

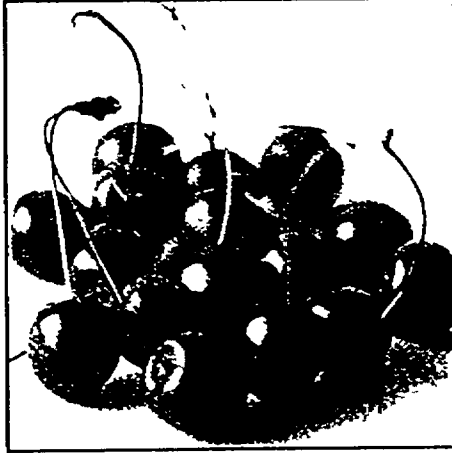

Ease arthritis with this scarlet fruit!



Boost your energy ... with broccoli!

# "Cinnamon Can Heal What?"

(By Frank K. Wood)

If you'd like to keep your memory sharp, control your cholesterol, and have more energy without dangerous drugs or risky surgery, you need *The Cure Conspiracy: Medical Myths, Alternative Therapies, and Natural Remedies Even Your Doctor May Not Know*, an informative new book just released to the public by FC&A Medical Publishing in Peachtree City, Georgia.

A must-have for anyone who sees a doctor, takes prescriptions, or uses over-the-counter remedies, this book cuts through the hype and conflicting claims to bring you a virtual encyclopedia of current remedies and therapies. Get the straight story on treatments from acupuncture to x-rays and everything in between. Find out how it works (if it works), how to use it, special cautions, and what the research really says. Covers conventional and alternative medicine, including herbs and supplements, plus a section on today's top medical myths. Thorough and unique, easy to read and use.

- ▶ Good news — you can eat as much of this food as your body can handle! It has absolutely no calories, and what's more, your body needs it to function at its peak.
- ▶ Keep your memory sharp as a tack! The secret to staying mentally alert as you age.
- ▶ Controlling cholesterol a major concern? Good news: This natural substance has been shown to lower cholesterol levels by up to 13% — and it lowered blood sugar levels by almost 20%!
- ▶ At last — a way to lower your cholesterol levels and keep them down for good.
- ▶ Tired and sluggish? Find out what kind of foods will give you more energy.
- ▶ How to get your prescriptions filled without spending a fortune at the pharmacy.
- ▶ Do you know the 9 signs of a heart attack in progress or ... about to begin? This wisdom is essential for every family member of anyone who has high blood pressure.
- ▶ Tap into the healing power of herbs. Facts on herbs that work, and ones to steer clear of.
- ▶ Ten natural arthritis pain relievers!
- ▶ Turn off a craving for sweets and melt off the pounds with this easy pantry weight-loss secret.

- ▶ What you drink for breakfast may determine your future health. Start your mornings off right to avoid type 2 diabetes!
- ▶ Add an extra 10 active years to your life! The most powerful treatment I found for reducing your risk of heart attack or stroke. Improves the quality of your life.
- ▶ Flatten your stomach without gut-wrenching exercises. These tips turn ugly flab into rock-hard abs!
- ▶ Flatten a bulging belly and strengthen stomach muscles — while strengthening your back — with this exercise. (And it's much easier than sit-ups.)
- ▶ Prevent clogged arteries, avoid poor circulation, even stop cataracts. Simple combination of vitamins and minerals does the trick.
- ▶ Feel better and have more energy ... in a matter of weeks!
- ▶ High Cholesterol? The newest "statin" drug lowers cholesterol levels better and with fewer side effects than other drugs.
- ▶ Having trouble sleeping through the night? Try cutting down on this in the evening — no, it's not caffeine!
- ▶ Prescription drugs that kill your memories. Before you blame senility or Alzheimer's, make sure you're not taking any of these drugs.
- ▶ Help stay healthy and cancer free, improve your chances, without drugs.
- ▶ How to rejuvenate your metabolism ... your body burns more fat automatically.
- ▶ If your doctor has told you your arteries are clogged, this 10,000-year-old remedy will help clean them out like a natural Roto-Rooter.
- ▶ Eating the right combination of foods may even be as important to losing weight as how much you eat.
- ▶ Beware! The 8 warning signs of stroke. Don't ignore any of them.
- ▶ Relieve neck pain, dizziness, nausea, blurred vision, and tinnitus with this simple procedure
- ▶ Cleanse your arteries! Can it really be done? Expert opinions.
- ▶ Flush your arteries clean of plaque and fatty buildup with this highly effective, all-natural, and completely safe program!
- ▶ Lose weight without even trying! That's what these men did — even while consuming the same total calories — when they ate this

- 50¢ meal each day. And they lowered their cholesterol, too!
- ▶ Worried about high cholesterol? Worry no more with this powerful little root. Also increases your strength and stamina and regulates your blood sugar.
- ▶ Millions of dollars are spent to keep these health facts hidden from us!
- ▶ How eating this "miracle meal" can lead to a long life — free from cancer, disease, and arthritis pain.
- ▶ 10 diet tips to control high blood pressure — no drugs involved!
- ▶ What to drink at 9 in the morning and 2 in the afternoon to keep your mind razor-sharp.
- ▶ Improve your memory and attention span with this product.
- ▶ Taking this substance helped increase mobility and ease joint pain in one volunteer group ... and you don't need a prescription for it!
- ▶ Seven sure-to-work ways to lower your blood pressure and fight the accompanying fatigue.
- ▶ A glassful of this with your meals can fight heart-damaging free radicals
- ▶ Want to lose some weight? These 6 sure-fire tips are proven to work even when nothing else has.
- ▶ Never underestimate the power of prayer! Medical research confirms its healing power.
- ▶ Back Pain: Save money with the amazing water cure.
- ▶ This popular Oriental herb is used throughout America for lowering cholesterol with the added benefits of a stronger immune system and more energy.
- ▶ Warning: This sugar substitute may cause headaches, dizziness ... even memory loss! Try this side effect-free sweetener instead.
- ▶ Your chances of suffering heart disease or a stroke drop by 33% to 50%! All because you did this.
- ▶ Many people who ignore these seemingly trivial symptoms drop dead of a stroke within three months!
- ▶ Loss of balance, muscle weakness, incontinence, moodiness, and dementia ... all caused by a simple vitamin deficiency that your doctor probably can't detect with a routine blood test!
- ▶ Why worry about ending up in the hospital when a 10-minute technique can keep you out of hospitals and save you tons of time

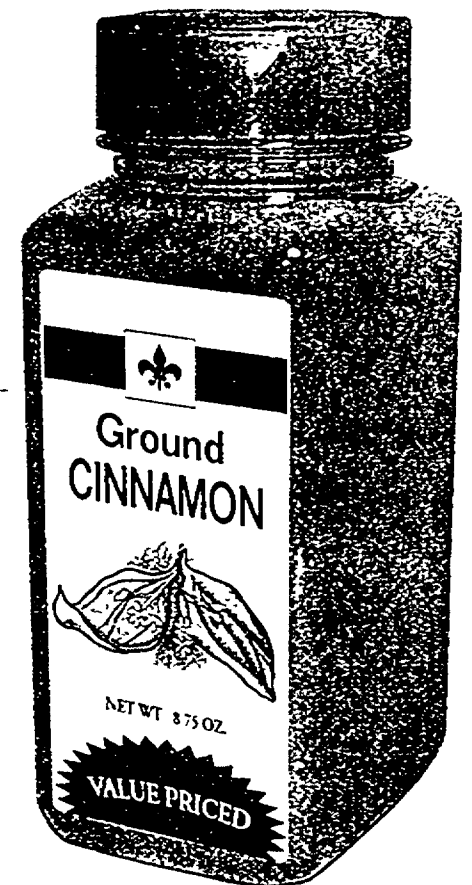

- and money!
  - ▶ Joint problems? Thanks to this nutritional supplement, your bones and conjunctival tissue can produce more collagen and rebuild damaged cartilage.
  - ▶ The "eyes" have it! Check out the many benefits you can give your eyes, when you know the secrets contained in this ancient Egyptian prescription!
  - ▶ Want to lose weight fast? Don't forget to eat this!
  - ▶ 3 teaspoons of this a day can help reduce blood cholesterol levels and control blood sugar levels in diabetics.
  - ▶ They were amazed by the results. And in only 24 days! If you or someone you know has high blood pressure, please check out the good news about this drug-free remedy.
  - ▶ 11 natural remedies for improving memory.
  - ▶ Don't lose your mind to old age! Start these strategies to prevent Alzheimer's later.
  - ▶ When using antioxidants such as vitamins C and E, it's important to also take this little-known coenzyme. It keeps them working at maximum speed, improving sugar metabolism up to 50%.
  - ▶ Your cholesterol plummets by 13% and your blood sugar levels drop almost 20%. Only one natural substance can give you results like these. Amazing!
  - ▶ 10 terrific tips for reducing blood pressure — without risky drugs! It's as easy as reaching for beans and bananas!
  - ▶ 7 natural ways to lower your blood pressure and protect your heart.
- Learn all these amazing secrets and more. To order a copy, just return this notice with your name and address and a check for \$9.99 plus \$3.00 shipping and handling to: FC&A, Dept. 9AV9D, 103 Clover Green, Peachtree City, GA 30269. We will send you a copy of *The Cure Conspiracy*.
- You get a no-time-limit guarantee of satisfaction or your money back.
- You must cut out and return this notice with your order. Copies will not be accepted!
- IMPORTANT — FREE GIFT OFFER EXPIRES OCTOBER 16, 2006**
- All orders mailed by October 16, 2006 will receive a free gift. *Get Well, Stay Well, guaranteed.* Order right away!

## Tidbits

## Did You Know...

**ILLINOIS**—Bonny Jain, 12, of Moline (pop. 43,768), won the 2006 National Geographic Bee and a \$25,000 scholarship in May by naming the mountains that extend across much of Wales from the Irish Sea to the Bristol Channel. (Answer: Cambrian)

**INDIANA**—The jerky driving habits of his lawyer inspired automotive pioneer Ralph Teetor of Hagerstown (pop. 1,768) to invent cruise control, a device he patented in 1945. Teetor was blind and especially sensitive to the stop-and-go motion of cars.

**IOWA**—A 3,100-pound, 7-foot-tall popcorn ball, billed as the world's largest, was produced in Sac City (pop. 2,368) in 2004. The recipe: 910 pounds popcorn, 1,500 pounds sugar, 690 pounds syrup and more than 40 energetic volunteers.

**KANSAS**—Settlers named Great Bend (pop. 15,345) for its location on a big bend in the Arkansas River. The Barton County (pop. 28,205) seat also was a popular stopping point and trading center on the Santa Fe Trail.

**MICHIGAN**—The Michigan Walk of Fame in Lansing pays tribute to 12 famous Michiganders

with bronze sidewalk plaques listing their names and achievements. Among those honored are automotive pioneer Henry Ford, musician Stevie Wonder and President Gerald R. Ford.

**MINNESOTA**—The Hubbell House Restaurant has welcomed guests to Mantorville (pop. 1,610) since 1854 when John Hubbell, one of the town's founders, built a log hotel there. Through the years, guests have included Gen. Ulysses S. Grant and publisher Horace Greeley.

**MISSOURI**—In 1904, St. Louis became the first city in the Western hemisphere to host the Olympic games, with most events held at Francis Field and Gymnasium at Washington University. Francis Field was rededicated 100 years later.

**NEBRASKA**—With help from a Hollywood friend, theater lovers saved the Midwest Theater in Scottsbluff (pop. 14,732) from the wrecking ball in 2002. One fund-raiser involved award-winning director and screenwriter Alexander Payne, an Omaha native whose volunteer efforts helped raise \$20,000 at the Midwest Film Festival. Payne directed the 2004 movie *Sideways*. The 1946 mod-

ernistic theater now hosts movies, concerts, plays and community events.

**NORTH DAKOTA**—The state's first commercial television station was KCJB, now KXMC, in Minnor (pop. 36,567), which began broadcasting in 1955.

**OHIO**—Scientist Paul C. Lauterbur shared the 2003 Nobel Prize in Physiology or Medicine for his pioneering work in magnetic resonance imaging (MRI), a painless scan of the human anatomy used to diagnose or rule out certain diseases. Lauterbur was born in 1929 in Sidney (pop. 20,211).

**SOUTH DAKOTA**—Rick Johns, craftsman and owner of the Landlocked Boat Shop in Vermillion (pop. 9,765), builds kayaks the traditional way: without glue or metal fasteners, but with wooden pegs and artificial sinew for lashings.

**WISCONSIN**—During World War II, when many minor league baseball teams disbanded, the All-American Girls Baseball League was formed by Chicago Cubs owner Philip Wrigley in 1943. The league was a hit, especially the Racine Belles, who won the first championship. ☆

**FREE** UP TO 4-ROOM SYSTEM - NOTHING TO BUY  
DIGITAL VIDEO RECORDER UPGRADE  
HIGH DEFINITION TV UPGRADE  
PROFESSIONAL INSTALLATION  
3 MONTHS OF HBO OR CINEMAX  
GENUINE APPLE IPOD THANK-YOU GIFT

CALL  
*mydish* NOW  
866-380-3075



## Medicare Covers Erectile Dysfunction Correction

Nothing impacts the sexual health and well-being of a couple and their intimate relationship more than Erectile Dysfunction (ED).

Therefore, any treatment used must address the needs of both people involved.

The male erection involves a very complicated interaction of many of the body's systems. The natural erection process can be interrupted by many underlying disease states and/or conditions.

The most common underlying causes of Erectile Dysfunction are: Diabetes, Hypertension, Vascular Disease, and Drug Interaction.

For many, the first-choice of treatment for ED should be Vacuum Therapy.

Unlike drugs, pills, or injections, Vacuum Therapy is non-invasive and has no side-effects. Negative pressure mimics the body's natural function and produces an almost instant erection.

This uniquely simple technology uses the body's blood to create erection much in the way the natural process works and maintains erection for sexual intercourse. The big difference is with Vacuum Therapy you control erection-with drug treatments the drug controls erection - not you.

*In fact, Vacuum Therapy is predictable, reliable, and gives spontaneous results other treatments simply cannot claim.* You and your partner will be able to control when, where and how long you want to be intimate.

Vacuum Therapy is also the only treatment that provides a significant therapeutic benefit while also creating functional erection.

Some men actually regain spontaneous erections as vascular health is improved using Vacuum Therapy. Countless couples have brought the joy back into their lives with the ED Vacuum Therapy systems.

Vacuum Therapy Systems are covered by Medicare and many insurance companies. That means little, if any out of pocket expense to you!

Vacuum Therapy Systems are safe, simple, effective, reliable, predictable, spontaneous and produces an almost "Instant Erection".

Each system includes an instructional manual, instructional video, pump head, cylinder, cylinder sizing inserts, loading cone, tension systems, personal lubricant, carrying case and LIFETIME MANUFACTURER WARRANTY.

Discount Diabetic also provides NO COST - Arthritis Heating Pads - covered by Medicare and many insurance companies! \*Deductible and copay may apply.

**Discount Diabetic** 

CALL DISCOUNT DIABETIC TODAY AT 1-800-717-6689 TO ORDER.



Photo: Jack Scallinopf

A former U.S. ambassador to the United Nations, Richardson also served seven terms in Congress.

(Continued from page 11)

Richardson says. "I try to be a mainstream American politician enormously proud of my Hispanic heritage, and I don't hide it. I feel strongly that if you are going to be representing the American people, you have to be part of the American mainstream."

### Listening to constituents

These days, he's focused on representing the people of New Mexico as he finishes his first term as governor. Richardson, who does not have children, puts in long hours in his spacious Santa Fe office, decorated with Southwestern and Indian art on loan from the state museum. He's cut the state's income tax rate and guided New Mexico to become the first state to provide life insurance for members of the National Guard on active duty.

Twice monthly, he holds an open house where he spends five minutes with any constituent who asks. "He's informal and it's just his style, and that reflects on how he relates to people," Barbara says. "He is not an intimidating person; he makes people feel comfortable, and he's pretty direct, too. If somebody is meeting with him, he'll say, OK, what can I do for you?"

When he's not working, he loves to ride horses and attend boxing matches and University of New Mexico basketball games. He ends his days in his study, watching ESPN and enjoying a Dominican Republic cigar.

"I like simple things," he says. "I'm not terribly sophisticated, although I've been fortunate to travel a lot. I feel that I can relate to people, and that my best years are ahead."

**Rate This Story**  
How did you like this story? Log on to [www.americanprofile.com/rate](http://www.americanprofile.com/rate)

# ADULT SMOKERS FIND A DIRECT LINE TO SMOKER'S WAREHOUSE AND SAVE \$3,000 A YEAR!

Now Pay Only **67¢** Per Pack

## It's Your Money!

### New! Improved! State-Of-The-Art! Makes Perfect Cigarettes In Seconds!

### YOU Are The FORGOTTEN CUSTOMER

NOT At Smokers Warehouse! Big tobacco had their way. That's why you are paying \$4, \$5 a pack and MORE. Big government had their way too, adding more and more sin taxes every day. And, who pays? **YOU DO!!!** Here's your chance to get even and make your own cigarettes in the comfort of your own home for the unheard of low price of just **\$0.67 (Sixty Seven Cents) a Pack!** You will receive the finest fresh cut All Natural USA Tobacco in your choice of Regular or

Menthol, zip lock packed for maximum freshness. Plus 600 preformed DeLuxe Filter Tips in your choice of Regular or Lights. It's quick, it's easy, and you will save big bucks. **Just \$19.95 gets you 3 Cartons (30 Packs) of great tasting cigarettes.**

**SURGEON GENERAL'S WARNING:**  
Cigarette Smoke Contains Carbon Monoxide

**YOU MUST BE OVER 21 YEARS OF AGE TO BE ELIGIBLE TO PURCHASE.**

Plus - Use The Coupon Below And **SAVE \$40.00** Guarantee: If you are not 100% delighted return the merchandise in 30 days, and we will refund every penny you paid for it.  
On The Amazing Supermatic II Machine (Regular Retail Price Of \$40.00)

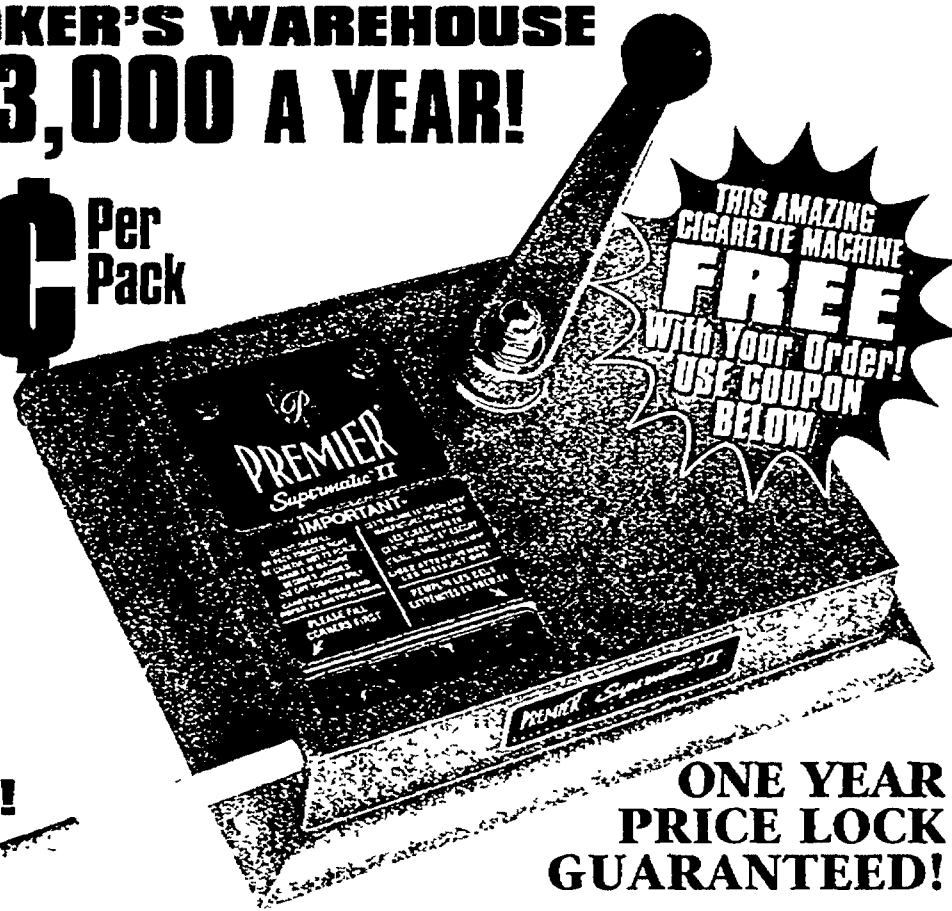

THIS AMAZING CIGARETTE MACHINE **FREE** With Your Order! USE COUPON BELOW!

## ONE YEAR PRICE LOCK GUARANTEED!

**IMPORTANT GUARANTEE - MUST READ**  
We Love Our Customers. And, they love us. We are guaranteeing your future shipments for ONE FULL YEAR at the unheard of low price of just \$0.67 Per Pack, Three Cartons for only \$19.95. At SMOKERS WAREHOUSE you are safe from being punished any more. You will receive your shipments every four weeks at the guaranteed low price, and you may cancel at any time. **GET STARTED TODAY!**

Mail TODAY To: **SMOKERS WAREHOUSE**  
11427 Commercial Ave., PO Box 489  
Richmond, IL 60071

**YES!** Please rush me the Complete Smokers Warehouse Package as shown here I will receive 30 packs (3 cartons) of Premium quality Virginia tobacco and 600 filter tips PLUS, the Supermatic II Machine, regular price \$40.00, now FREE with my Discount Coupon! (Limit one per household) **AP600**

CHECK YOUR CHOICE OF TOBACCO CLEARLY  
 Regular  LIGHT Regular  
 Menthol  LIGHT Menthol

CHECK CHOICE OF FILTERS CLEARLY  
 Regular Filter  LIGHT Filter

Please send me the complete introductory offer as shown here with the understanding that every four weeks I will continue to receive the pre-formed filter tips and tobacco to make thirty packs of cigarettes. I understand that I will pay \$19.95 (\$0.67 per pack) plus a shipping charge of \$6.95. After I receive the introductory offer I may change the quantity, frequency of delivery, or cancel in full at any time and owe nothing more. Regardless of my decision I can keep the Supermatic II Machine FREE.

**SUPERMATIC II - SPECIAL OFFER - YOURS FREE**  
Tobacco/filters \$19.95 And Supermatic II Machine NO CHARGE  
Add Shipping/Handling \$6.95 (Your Total Order Only \$26.90)

PLEASE CHARGE TO MY  VISA  MasterCard  American Express Or  Discover  Exp. Date

Account Number Please Print All Digits Clearly

Name \_\_\_\_\_

Street \_\_\_\_\_

City \_\_\_\_\_

State \_\_\_\_\_ Zip \_\_\_\_\_

Phone No \_\_\_\_\_

X Signature Required - I hereby state that I am over 21 years of age

Your Birth Date Month \_\_\_\_\_ Day \_\_\_\_\_ Year \_\_\_\_\_



**SMOKERS WAREHOUSE**  
11427 Commercial Ave. • PO Box 489 • Richmond, IL 60071  
Special Offer By Mail: Use Order Form - MAIL TODAY or,  
A FREE CALL: 866-672-3687 Ask For Special Offer Code 600



Photos: Tony Avolar

# Collecting Treasures of "The King"

by J. POET

Robin Rosaaen stands in front of her apartment in suburban San Jose, Calif. "Prepare to enter the house of Elvis," she says as she ushers her visitors through the front door.

Every room in Robin Rosaaen's California apartment reflects her passion for things associated with Elvis Presley.

The hallway, like every other room in her home, is stacked from floor to ceiling with Elvis collectibles of every kind—an estimated 10,000 records, books, playing cards, posters, figurines, license plates, key chains, magazines and other items, plus some 80,000 rare photos.

"I know it's out of hand," says Rosaaen with a smile, moving sideways through a narrow corridor between neatly arranged piles into the living room. "But when I see something I need to fill in the collection, I go for it."

Rosaaen's collection of Presley memorabilia boasts unique treasures from every era of The King's life from 1956 until his death in 1977.

Elvis authority Cory Cooper, a frequent source for books and radio shows about Presley and his music, says Rosaaen has "probably one of the top five private Elvis collections" in the world.

Rosaaen, 59, is happy to show off unlikely treasures like her 4-foot-high fiberglass Elvis Mardi Gras head, Presley's complete dental records, the neatly framed

divorce decree ending his marriage to Priscilla; the sweatshirt his co-star Joan Blackman wore in the movie *Kid Galahad*; and dozens of objects from 1956, the pivotal year Presley broke through from obscurity to fan-frenzy, no-going-back stardom.



Rosaaen's vast collection includes memorabilia from Presley's movies, singing career and personal life.

"1956 wasn't just a banner year for Elvis, it was the year," says *San Francisco Chronicle* pop music critic Joel Selvin. "Eight network TV appearances, his first No. 1 record, something like 3 million records sold. In January, he was a complete unknown; by December, he was the best-known name in show business."

Many of Rosaaen's Elvis treasures were acquired when she worked at the online auction site eBay.com in the 1990s and directed her Elvis passion into managing the website's special section of Presley collectibles.

"I'd already written a book called *All The King's Things: The Ultimate Elvis Memorabilia Book*," she says. "It's a guide for collectors arranged according to theme—movies, the '50s, the '60s. I went on talk shows like *Good Morning, Oprah* and Joan Rivers' *Can We Shop?* to promote it, so I had the expertise to deal with all things Elvis."

Rosaaen grew eBay's "King's Things" site to a staggering 5,000 online pages, but got laid off in 2001 when

(Continued on page 20)

# BLAIR®

## Cozy Fleece Jacket... Your best buy for grab and go comfort!

**SAVE \$5**  
Special Introductory Price:  
**\$14.99**  
Regularly \$19.99

Women all across the nation love this fleece jacket for its cozy softness and go-anywhere style. And you will, too — especially at our welcome-to-Blair price!

Easy-going design makes it your perfect top layer. Premium knit fleece always keeps you comfortable. Solids are polyester/cotton; heathers are polyester/rayon/cotton (prints can be on heathers also.) Imported.

A rainbow of colors to choose from! Order your favorite today, risk-free.

**SATISFACTION GUARANTEED.**  
**ABSOLUTELY!** If your jacket ever fails to perform to your satisfaction, return it for replacement, refund or credit for the purchase price.

This offer cannot be combined with any other offers

**FREE Shipping**

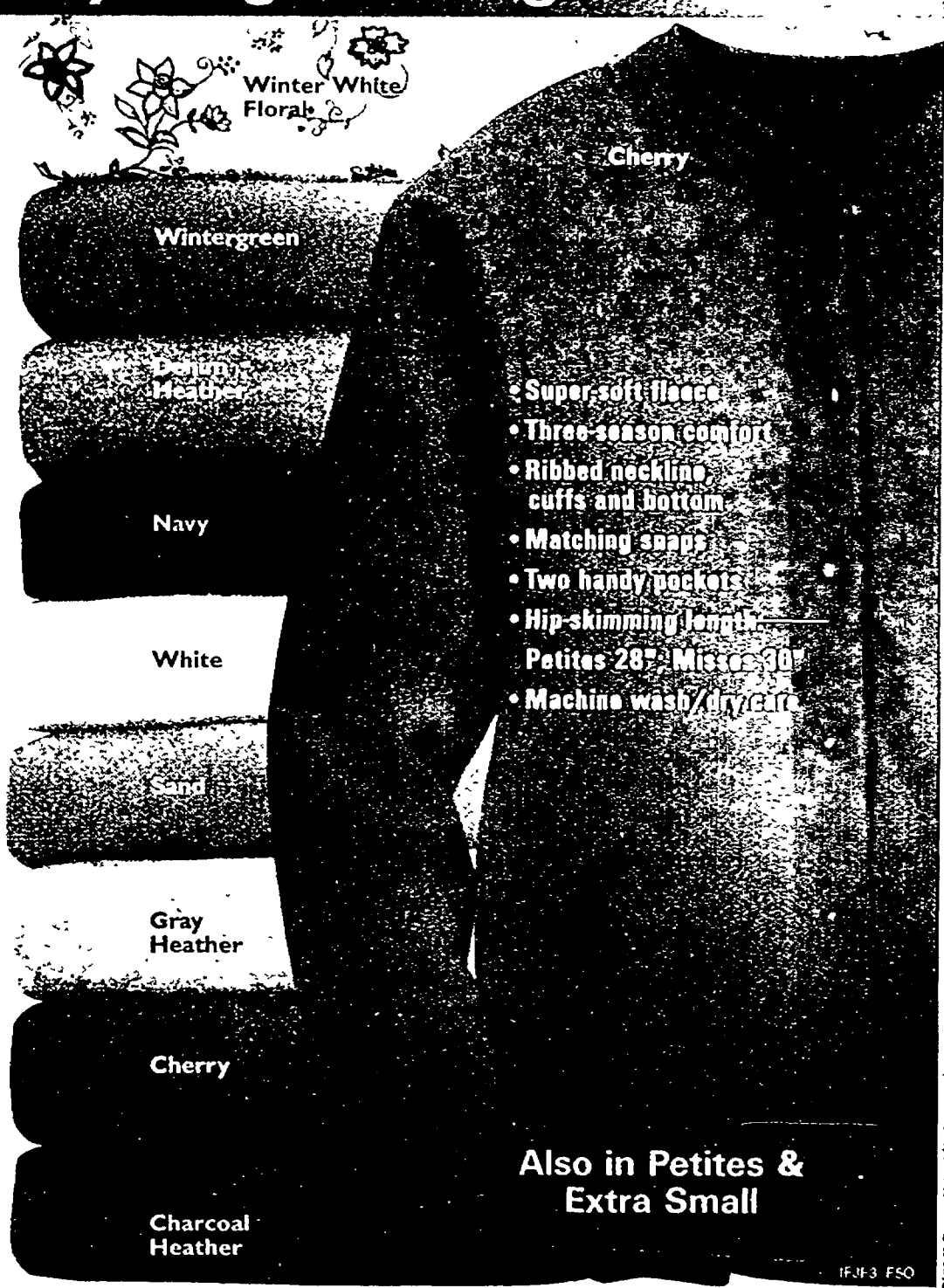





**BLAIR.com/special** Go to Blair.com/special and enter the priority code located in the yellow box to the right, to get your special introductory offer.

PRIORITY CODE  
**WEW-M**

Check size & color choice \$14.99    32747	PETITES						MISSES						
	PXS	PS	PM	PL	PXL	P2XL	XS	S	M	L	XL	2XL	3XL
WHITE 04													
CHERRY 02													
CHARCOAL HEATHER 19													
DENIM HEATHER 08													
NAVY 03													
SAND 18													
WINTERGREEN 24													
GRAY HEATHER 05													
WINTER WHITE FLORAL 3274661													

F.F3 F50

FREE SHIPPING when you pay with the following

- Check or money order enclosed
- Charge my    

Card # \_\_\_\_\_

Signature \_\_\_\_\_ Exp. Date \_\_\_\_\_

This offer cannot be combined with any other offers

Miss  Mrs  Mr **WEW-M**

Address \_\_\_\_\_ Apt # \_\_\_\_\_

City \_\_\_\_\_ State \_\_\_\_\_ Zip \_\_\_\_\_

Home Phone No. (\_\_\_\_\_) \_\_\_\_\_

Email \_\_\_\_\_

BLAIR®, 220 HICKORY STREET, WARREN, PA 16366

F.F3 F50

A Historic Collecting First... Celebrate the "King of Rock 'n Roll"

*Elvis Presley*

**50th Anniversary  
Collector Coins**

**Complete Five  
Coin Set Just \$9.95**

Officially authorized by Elvis Presley Enterprises

Own the official coins to celebrate the 50th Anniversary of Elvis Presley's very first chart-topping hit songs released in 1956. Each coin is a Tennessee State Quarter - referred to as the Elvis state quarter - incredibly color enhanced by the Morgan Mint with a different portrait image of Elvis - creating five stunning works of art to treasure.

**DOUBLE THE COLLECTOR VALUE!**

The 50th Anniversary Collector Coins consists of five legal tender, Brilliant Uncirculated condition - limited edition and sold-out - Tennessee U.S. Statehood Commemorative Quarter dollar coins released by the U.S. Mint in 2002. The Morgan Mint has made special arrangements to secure enough of this impressively valuable quarter for this very special collector's set.

Demand for the Elvis Presley 50th Anniversary Collector Coins is expected to be great, so you must act quickly to reserve your set today! A limit of 3 (three) sets per collector at our Special Introductory giveaway price.

**TO ORDER BY MAIL**, send your name, address and number of sets requested to the address shown below. Include a check payable to Morgan Mint for \$9.95\* per coin set plus \$4.99 postage and handling (total \$14.90\* for each coin set requested).



Coins shown larger than actual size of 24.3mm

For fastest service, please have your credit ready and call Toll free:

**1-800-414-1198**

Dept. ESQC113  
Mon-Thu 9am-9pm ET • Fri 9am-6pm ET  
Sun 9:30am-8pm ET

**Mail Orders:**

NY state residents add applicable sales tax. Include a check for the total amount and send to:



**THE MORGAN MINT**  
Dept. ESQC113  
290 Duffy Avenue  
Hicksville, New York 11801

**SATISFACTION GUARANTEED OR YOUR MONEY BACK!**

**THE HOTTEST COINS IN AMERICAN HISTORY ARE GOING FAST!!**

AND WE'VE GOT THE RAREST OF THEM ALL...THE FIRST

**10 STATE QUARTERS**  
BRILLIANT UNCIRCULATED CONDITION, LAVISHLY LAYERED IN  
**PURE .999 FINE GOLD**

AN INCREDIBLE \$130 VALUE! **ONLY \$10<sup>00</sup>**

**ORDER WITHIN 48 HOURS AND GET A FREE \$50 MUSEUM DISPLAY CASE!**

The gold-layered coins in this collection could cost you up to \$130 if ordered elsewhere - but you can own all 10 coins for the special introductory price of only \$10 including a FREE \$50 cherrywood-finish Display Case with spaces for every gold-layered coin in the State Quarters series. Offer limited to new customers only while supplies last! Limit three (3) sets per collector at this price.



**TO ORDER BY MAIL**, send your name, address and number of sets requested to the address shown below. Include a check payable to Morgan Mint for \$10 per set plus \$10 postage and handling (total of \$20) on your FREE Museum Display Case.



**SATISFACTION GUARANTEED OR YOUR MONEY BACK!**

For fastest service, use your credit card and call Toll-free:

**1-800-414-1198**

Dept. SQG956

MON-THU 9AM-9PM ET • FRI 9AM-6PM ET  
SUN 9:30AM-8PM ET

To order by mail, send name, address, phone no. & check for \$20 to:

**THE MORGAN MINT**  
Dept. SQG956  
290 Duffy Avenue  
Hicksville, New York 11801

NY State residents add applicable sales tax



www.morganmint.com



Rosaaen with the sweatshirt worn by Presley's co-star, Joan Blackman, in *Kid Galahad*

(Continued from page 18)

the company restructured. She's since made her living buying and selling Elvis memorabilia among the worldwide network of collectors she developed during her years at eBay.

Her journey to Elvis collector extraordinaire began as a young woman when she saw Presley on his famous 1968 televised "comeback" special. Electrified, she drove to Las Vegas to see him in person. "I saw him 72 more times before he died," she says, "usually in Las Vegas from seats down in front."

Presley became accustomed to seeing Rosaaen just beyond the stage footlights. In 1974, during a performance, he leaned over and put one of his scarves around Rosaaen's neck. "He kissed me and called me Rockin' Robin," she says. "It's been my nickname ever since."

She had reservations to see Elvis in 1977 in Las Vegas, but the concert never happened due to Presley's death on Aug. 16 of that year.

Some day Rosaaen would like to open a gallery to display her items. Meanwhile, she's busy adding to her collection, brokering sales of Elvis memorabilia for other collectors, and licensing photos to publishers, documentary filmmakers and programs such as the E! Channel's *Last Days Of Elvis*.

"I've been making a living off of my collection for years now," she says. "I feel like Elvis is looking after me." ☆

*Just past is a writer in San Francisco.*

**Rate This Story**

How did you like this story? Log on to [www.americanprofile.com/rate](http://www.americanprofile.com/rate)

**SPECIAL ELVIS OFFER**

**The King Lives . . . In The Kitchen!**

*Fit For A King - The Elvis Presley Cookbook* brings you all the foods Elvis loved to eat. From his world-famous Peanut Butter and Banana Sandwich (it's grilled) to the Deviled Eggs served when the Beatles stopped by Graceland for a midnight supper! Many recipes are from Alvena Roy, Elvis' long-time cook. More than 300 recipes and 70 photographs - many published here for the first time. Order now!

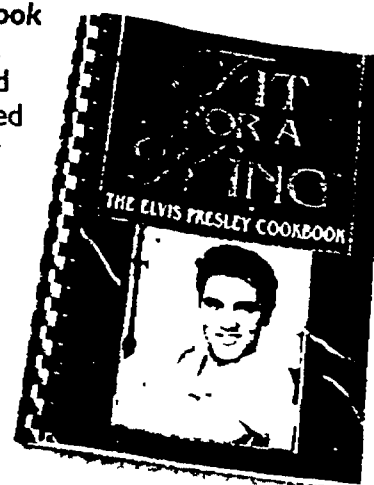

Limited quantities available - to order, visit [www.americanprofile.com/store](http://www.americanprofile.com/store) or please have your credit card ready and call (800) 715-6248 or send check for \$19.99 to Elvis Cookbook - Dept. AP, P.O. Box 340, Harrison, AR 72602.

CA, TN, IL, AR, NY residents add state sales tax. NSF checks automatically debited for amount of check plus applicable fees. Expires 11/10/06. Please allow 2-4 weeks for delivery. Offer good while supplies last!

*Aglow with the true spirit of Christmas!*  
**First Ever Thomas Kinkadee  
 Illuminated Nativity Tree!**

An impressive 16" high with illuminated Crèche and Nativity structures, and over 40 characters all hand-crafted!

For the first time... the story of the Nativity comes vividly to life in a three-dimensional, fully sculpted, illuminated miniature tree inspired by the *Painter of Light*. The Thomas Kinkadee "Glory To The Newborn King" Illuminated Nativity Tree is entirely hand-crafted to retell the blessed event step by step—from the Three Kings' journey to Bethlehem, to the heavenly angels bringing good tidings and praise, to the night Jesus was born. Hand-painted scenes and figurines nestle cozily within its lush, sculptural greenery. Reflecting a warm, holiday glow, the tree and structures illuminate—with just a flick of the switch, and plays the cherished Christmas carol, *Silent Night*. The brilliant crystalline Christmas Star treetopper, beautiful mahogany finish base and brass name plaque make it truly a one-of-a-kind.

**Urgent Notification! Availability Is Strictly Limited.** Given the time-intensive hand-crafting, demand could rapidly exceed availability. Be one of the first to get this incredible Nativity tree, remarkably priced at \$135, payable in 4 convenient installments of just \$33.75\*. *Your prompt response is critical. To order, send no money now. Simply complete and mail the attached coupon today!*



The Holy Family looks radiant under the soft glow of the illuminated Crèche.

It Lights Up!



Back View: Beautiful from any view

THOMAS KINKADEE  
*Painter of Light*



Plays the cherished melody of *Silent Night*

Powered by AC adapter (included) or 3 "AA" batteries (not included).

Shown smaller than actual size.

collectiblestoday.com

©2006 Thomas Kinkadee

Each meticulously sculpted detail is crafted and painted by hand



HAWTHORNE VILLAGE

9210 N. MARYLAND ST., NILES, IL 60714-1322

Limited-time Offer—Please Respond Promptly.

**Yes!** Please reserve the Thomas Kinkadee "Glory To The Newborn King" Illuminated Nativity Tree Masterpiece Edition as described in this announcement. **SEND NO MONEY NOW.**

Certificate of Authenticity and 365-Day Money-Back Guarantee

Signature \_\_\_\_\_  
 Mrs. Mr. Ms \_\_\_\_\_  
 Name (PLEASE PRINT CLEARLY) \_\_\_\_\_  
 Address \_\_\_\_\_ Apt. No. \_\_\_\_\_  
 City \_\_\_\_\_ State \_\_\_\_\_ Zip \_\_\_\_\_

1400101001-E57102

Plus \$14.99 shipping and service. All sales are subject to acceptance and product availability. Please allow 4-6 weeks for delivery. ©2006 Hawthorne Village 14 10101 001 HIAP





YES! Please send one pair of "Genuine Suede Moccasins" for only **\$7.69**

Add \$3.95 postage and handling per order.

GSM-0066

**SAVE** →

- 2 pair for **\$15.00**  
 3 pair for **\$22.00**

Total enclosed \$ \_\_\_\_\_

Name \_\_\_\_\_

Address \_\_\_\_\_

City \_\_\_\_\_

State \_\_\_\_\_

Zip Code \_\_\_\_\_

Mail check or money order payable to

**SAVE BY MAIL Inc.**

Dept G8422, P.O. Box 2847

Plattsburgh, New York 12901

**30 Day No Nonsense Refund Guarantee**  
Less Postage & Handling

Men			Women		
Qty	Size	Color	Qty	Size	Color

# Men's & Women's Genuine Suede Moccasins

Non-Slip Crepe Soles Protect Your Feet  
Genuine Moccasin Comfort with Whip-Stitched Suede Leather Uppers



*Perfect Indoors  
AND  
Outdoors Too!*

**ONLY**  
**\$7.69**  
per pair

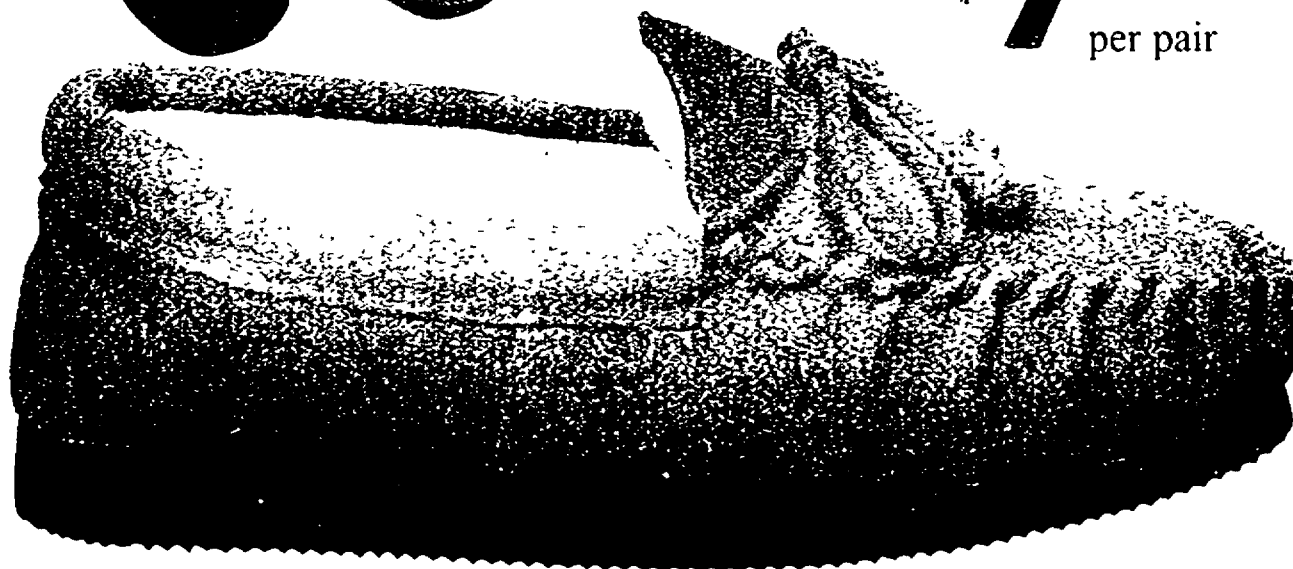

- Choice of blue, brown, black, grey or red.
- Completely Lined In Deep, Luxurious, Acrylic Plush Fleece.

Genuine suede leather moccasins offer double-duty comfort and value. Wear them inside and be pampered from heel to toe, wrapped in the cloud like luxury of soft acrylic fleece. Outside, the sure-grip crepe soles give you the confidence of non-slip security. Split leather suede cowhide uppers with adjustable laces allow you to personalize comfort and fit. Your choice of blue, brown, red, grey or black. Women's sizes 6 to 10. Men's sizes 7 to 12.

**Specify men's or women's, color & size**

Women's sizes 6 to 10. Men's sizes 7 to 12. Available in blue, brown, red, grey or black.

## Our Picks

Read more Our Picks online at  
[www.americanprofile.com](http://www.americanprofile.com)

**Wonderful  
Life**

SO ELEGANT TO  
LIFT THE SPIRIT

**A Wonderful Life  
Edited by Cyrus  
M. Copeland**

Subtitled "50 Eulogies to Lift the Spirit," this collection of fond farewells to entertainers (Bob Hope, Gregory Peck, John Belushi), famous

athletes (Mickey Mantle, Charles Atlas, Arthur Ashe) and other noteworthy 20th-century movers and shakers (Rosa Parks, Princess Diana, Martin Luther King Jr.) also includes a special section devoted to four New York City firemen who lost their lives on Sept. 11, 2001. These transcripts remind us that no one lives forever—but, if you're lucky, you'll have someone warm or witty to say a few wonderful words and tend the flame of your memory after you're gone.

**Hoot  
DVD**



You'll cheer as a trio of lovably misfit kids in this wholesome drama/comedy schemes to protect the endangered Florida habitat of a family of owls from a greedy land developer, avoid a comically clueless policeman (Luke Wilson) and resist the taunts of a local schoolyard bully. It's family fun woven from the thread of a serious, eco-sensible message, sailing along to the sweet strains of a tropical-tinged soundtrack with new songs by Jimmy Buffett, who also co-stars, and loaded with a bonanza of DVD extras, including bloopers, interactive games and mini-features. (Rated PG) ☆

To order *A Wonderful Life* for \$22.95 (INCL. S/H) or *Hoot* for \$34.95 (INCL. S/H), go online to [www.americanprofile.com/store](http://www.americanprofile.com/store) or please have your credit card ready and call (800) 715-6248; or send check to Our Picks - Dept. AP, P.O. Box 340, Harrison, AR 72602.

Residents of CA, TN, IL, AR and NY add sales tax. NSF checks will be automatically debited for the amount of the check plus applicable fees. Offer is limited and expires 11/10/06. Please allow 2-4 weeks for delivery.

Our lowest price ever... Call Toll Free Today!

“TV Ears  
saved

OUR  
marriage!

Darlene and Jack B., CA

Listen to TV at your own level  
without disturbing others.

Our  
lowest  
price ever  
and  
FREE  
Shipping

TV Ears® has helped thousands of people hear  
television clearly without turning up the volume.

More than 28 million Americans have some degree of hearing loss. If you struggle to hear TV, or family members complain the TV is too loud, you need TV Ears! TV Ears® is a powerful new device that has helped thousands of people with mild, moderate, or severe hearing loss hear the television clearly without turning up the volume. Now you can listen to television at your own level while others may adjust the volume to fit theirs. TV Ears® helps you hear every word clearly. Imagine watching your favorite programs, and actually being able to hear every word and sound—it will change your life!

If you are dealing with the frustration and arguments that come with turning up your TV volume too loud...read on.

From George Dennis, president and founder of TV Ears, Inc.

“The inspiration for TV Ears was based on the well-known statistic that nearly 80% of people with hearing loss go undiagnosed and untreated for a variety of reasons which may include vanity or cost of treatment. TV Ears has proven to be an appealing product to the average person and an excellent introduction to those seeking improved hearing health.”

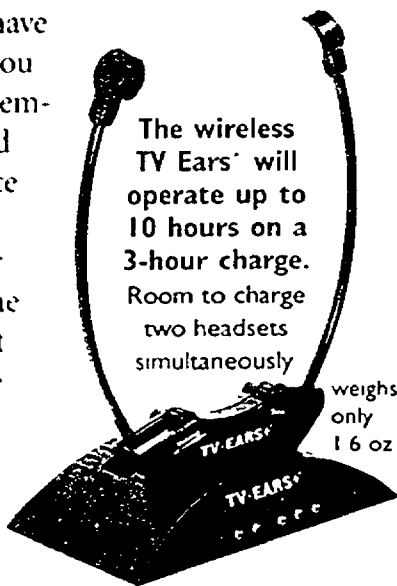

The wireless TV Ears® will operate up to 10 hours on a 3-hour charge. Room to charge two headsets simultaneously

weighs only 1.6 oz

TV Ears® is powerful (120 dB), and features voice enhancement technology to make hard to hear words easier to understand and keep background sounds in the background. The cheaper, commercial headsets are limited in output and amplify all sound at the same level.

“Now my husband can have the volume as loud as he needs...and I can have the TV at my hearing level. “TV Ears” are so uncumbersome that Jack forgets he has them on! He can once again hear and understand the dialogue. We have given “TV Ears” as a gift to dear friends. They are absolutely the finest product.” Sincerely

— Darlene and Jack B., CA

Try them yourself! If you aren't totally amazed...send them back! We're so sure you'll be absolutely astonished with the increase in sound and clarity when using the TV Ears that we're backing them with firstSTREET's exclusive in-home 90-day trial. If you aren't completely satisfied, simply return them for the product purchase price.

Hear every word with today's technology!

- **Television Audio Processing.** (TAP) The transmitter processes the audio from your TV or other audio devices and amplifies regular dialogue, hard to hear voices, and whispers.
- **Automatic Volume Control.** (AVC) Selectively compresses loud bursts of volume that are annoying when watching a program, channel surfing, or during commercials.
- **Infrared technology.** TV Ears' infrared technology provides safe, superior sound quality without interference and frequency drifting. Transmits up to 900 square feet.
- **Left-Right balance control.** Allows you to adjust the volume for rich, high-quality sound in both ears.
- **Individual controls.** Multiple headsets can be adjusted to the user's personal needs.
- **Long-lasting charge.** You can quickly charge two headsets at the same time, and TV-Ears will function up to 10 hours on a 3-hour charge. Charger included

TV Ears® Item# TE-3874

Now \$99.95 each

Special FREE shipping - a \$17.95 Value  
Ask about our special price on additional headsets  
Please mention promotional code 31854.

For fastest service, call toll-free 24 hours a day

**1-800-805-0562**

To order by mail, please call for details.

Special offer on phone orders only!  
Market research test limited time only.

**firstSTREET®**  
SEE IT HERE FIRST

1998 Ruffin Mill Road  
Colonial Heights, VA 23834



# Purely You

## Relive your trip with the push of a button.

With Dell™ MediaDirect™ you can access your photos and videos in seconds without having to boot up your operating system.

### Inspiron™ E1505 Notebook

- Intel® Centrino® Duo Mobile Technology
- Intel® Core™ Duo Processor T2050 (1.60GHz)
- Intel® PRO/Wireless 3945 Internal Wireless (802.11a/b/g)
- Genuine Windows® XP Media Center Edition 2005
- 15.4" Widescreen XGA Display with TrueLife™
- 1GB Shared\* Dual Channel\* DDR2; 120GB\* Hard Drive
- CD/DVD Burner\*
- Integrated Sound Blaster® Audigy® HD Software Edition
- 1-Year Limited Warranty\*, Mail-In Service, Hardware Warranty Support
- No Charge for 3-5 Day Shipping & Handling - Online Only

Regularly priced \$999

**\$799** after \$194 off  
or as low as \$24/mo.▲  
E-Value Code: 08281-0009096

### Power up.

- Internal Dell™ Wireless 355 Bluetooth™ Module
  - 15.4" UltraSharp™ Widescreen SXGA+ Display with TrueLife™
  - 128MB ATI Mobility™ Radeon™ X1300 HyperMemory™
- Add for \$200. E-Value Code: 08281-000911A

Feel secure. Upgrade to 3-Year Limited Warranty\*, At-Home Service\* and Hardware Warranty Support for \$210.

### Other Dell™ Notebooks

start at \$499 after instant savings.  
E-Value Code: 08281-080905f  
Call or go online for more details.

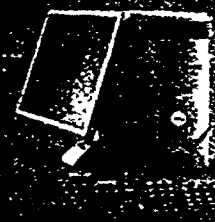

Shown with 15" Flat Panel Display (15.4") Add for \$194

Dell recommends Windows® XP Media Center Edition.



### Dimension™ B110 Desktop

Entry Level Desktop

- Intel® Celeron® D Processor 325 (2.53GHz)
- Genuine Windows® XP Home Edition
- 256MB Shared\* DDR SDRAM; 80GB\* Hard Drive
- CD Burner/DVD Combo Drive
- 17" (16.0" v.i.s., .27dp) CRT Monitor (15" Flat Panel Display Shown - Add for \$130)
- 1-Year Limited Warranty\*, At-Home Service, Hardware Warranty Support

Regularly priced \$349

**\$299** after \$50 off  
or as low as \$9/mo.▲  
E-Value Code: 08281-0509026

Feel secure. Add a 15-Month Subscription to Trend Micro® PC-cillin™, Internet Security™ with Antivirus, Firewall and Spyware Removal for \$79. Upgrade to 3-Year Limited Warranty\*, At-Home Service\* and Hardware Warranty Support for \$110.

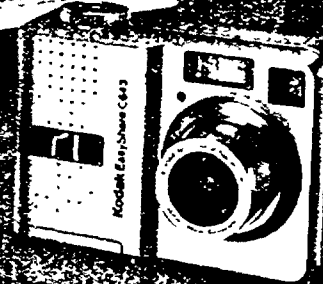

Shown with 15" Flat Panel Display (15.4") Add for \$130

Dell™ EasyShare™ C6400 Digital Camera \$200  
SKU: A0612061

# 1-800-660-8654

Shop by phone 7 am - 11 pm CT  
For hearing/speech impaired: 1-877-DELL-TTY (toll-free)

# www.dell.com/profile

Visit a Dell Direct Store  
For locations,  
go to [www.dell.com/mall](http://www.dell.com/mall)

**\*DELL PREFERRED ACCOUNT (DPA):** Offered by CIT Bank to qualified U.S. residents with approved credit. Creditworthiness determined by lender. Taxes, fees, shipping, handling and any other applicable charges are extra, and vary. Monthly payments based upon pre-rebate price. Minimum monthly payments of \$15 or 3% of account balance, whichever is greater.

**\*PRICING/AVAILABILITY:** Prices, specifications, availability and terms of offers may change without notice. Taxes, fees, shipping, handling and any applicable restocking charges are extra, and vary. Offers may be combined with other select offers or discounts. Valid for U.S. Dell Home Systems Co. new purchases only. Dell cannot be responsible for pricing or other errors, and reserves the right to cancel orders arising from such errors. **LIMITED WARRANTY:** You can get a copy of our limited warranties and guarantees by writing Dell USA LP, Attn: Warranties, One Dell Way, Round Rock, TX 78682. To purchase warranty only or for information on other service options please call 1-800-915-3355 or visit [www.dell.com/termsandconditions](http://www.dell.com/termsandconditions). **AT-HOME SERVICE:** At-Home service provided via third-party contract with customer. Technician will be dispatched, if necessary, following phone-based troubleshooting on the next business day. Availability varies. Other conditions apply. **HARD DRIVE:** For hard drives, GB means 1 billion bytes; actual capacity varies with preloaded material and operating environment and will be less. On Dimension, XPS and Inspiron systems for Norton Ghost 10 and Dell DataSafe users, up to 25% of the stated hard drive capacity may be utilized by your system as dedicated backup space. **SHARED SDRAM:** Up to 224 MB of system memory may be allocated to support integrated graphics, depending on system memory size and other factors. **DUAL CHANNEL MEMORY:** Dual channel memory requires 2 each of the same capacity memory DIMMs. **DVD BURNER:** Discs burned with this drive may not be compatible with some existing drives and players, using DVD-R media provides maximum compatibility. **TREND MICRO PC-CILLIN:** This offer is only available when purchased at point of sale and is not available after you receive your system. **BLUETOOTH:** The Bluetooth word mark and logos are owned by the Bluetooth SIG, Inc., and any use of such marks by Dell Inc. is under license. Other trademarks and trade names are those of their respective owners. **128MB ATI MOBILITY RADEON X1300 HYPERMEMORY:** The total of local and shared system memory used by this graphics card is up to 128MB. Local on-board memory is 64MB. Up to 64MB of system memory may be allocated to support graphics, depending on system memory size and other factors. **TRADEMARKS/COPYRIGHT NOTICES:** Intel, Intel Logo, Intel Inside, Intel Inside Logo, Celeron, Celeron Inside, Centrino, Centrino Logo, Intel Core, Core Inside, Pentium, and Pentium Inside are registered trademarks of Intel Corporation or its subsidiaries in the United States and other countries. Microsoft and Windows are registered trademarks of Microsoft Corporation. ©2006 Dell Inc. All rights reserved.



## Dual-core. Do more.

4 PAGES OF BONUSBUY SAVINGS

# KOHL'S®

expect great things®

## Anniversary sale

sale starts Thursday, Sept. 14

save an  
extra

# 15%

on everything in  
store & online  
every time you  
use your Kohl's  
Charge

Thursday-Tuesday,  
Sept. 14-19, 2006

See page 29 for details.

KOHL'S

KOHL'S

**30-40% off**  
all apt. 9™ sportswear,  
accessories & shoes

**32.99**  
Norton McNaughton®  
embroidered blouse.  
orig. \$48

**23.99**  
Requirements®  
notch collar  
jacket.  
orig. \$40

**24.99**  
Norton McNaughton®  
pants. orig. \$30

**23.99**  
Requirements®  
orig. \$40

**REQUIREMENTS**

**12.99**  
Croft & Barrow®  
long-sleeved  
printed  
knit tops  
for misses.  
orig. \$20

croft & barrow®

**21.99**  
Croft & Barrow®  
zip cardigan  
for misses  
and petites.  
orig. \$34

croft & barrow®

**24.99**  
Croft & Barrow®  
pants  
for misses  
and petites.  
orig. \$36

croft & barrow®

**30-40% off**  
**entire stock**  
Sonoma  
sportswear.  
for misses, petites  
and women.  
orig. \$18-\$46,  
sale 12.60-32.20  
selected items  
online W2830

SONOMA  
LIFE style  
ONLY AT KOHL'S

**20-40% off**  
**entire stock**  
Gloria Vanderbilt® Sport,  
N.Y.L.®, Danskin®,  
daisy fuentes® sport,  
Russell® Athletic,  
Fu Da®, Nike®,  
adidas® and  
Tek Gear®  
active- and  
fitnesswear  
for misses.  
orig. \$16-\$50,  
sale \$12-\$40  
selected items  
online P9134

GLORIA VANDERBILT  
N.Y.L.  
NEW YORK LAUNDRY

**Entire Stock**  
**26.99**  
Lee® Midrise boot  
cut jeans, Natural  
Straight leg twill  
pants & jeans or  
Plain Front Stretch  
twill pants  
for misses & petites.  
Women's Lee® Plain  
Front twill pants,  
sale 29.99

**Entire Stock**  
**29.99**  
Dockers® Sydney,  
Metro or Jillian  
boot cut pants  
for misses & petites.  
Women's Dockers®  
Metro pants,  
sale 31.99

**33% off all outerwear**  
for misses, women and juniors  
orig. \$45-\$250, sale 29.99-165.99

SONOMA  
LIFE style

**30-40% off entire stock**  
Norton McNaughton®, Requirements®, Croft & Barrow®,  
Villager, Sag Harbor®, West End, Briggs®, Cathy Daniels  
and Notations sportswear for misses  
orig. \$14-\$99, sale 8.99-69.30 selected items online W2300

KOHL'S  
**save an extra 15%**

**on everything in store & online every time you use  
your Kohl's Charge Thurs.-Tues., Sept. 14-19, 2006**  
Save on all sale- regular- and clearance-priced merchandise. Subject to credit approval. See page 29 for details



**33.99**  
 Nine & Co.®  
 crochet wrap  
 sweater.  
 orig. \$49

**26.99**  
 daisy fuentes®  
 wrap sweater.  
 orig. \$39

**27.99**  
 Nine & Co.®  
 career pants.  
 orig. \$40

**29.99**  
 daisy fuentes®  
 5-pkt. denim pants.  
 orig. \$44

NINE  
 & CO.

daisy fuentes®

**save 30-40% on all**  
 Nine & Co.®, daisy fuentes®,  
 access and AB Studio collections

for misses, petites and women. orig. \$18-\$64, sale 12.60-44.80 Q selected items online W2300

Entire Stock  
**30-50%**

Petites'  
 sportswear  
 from apt. 9™,  
 Sag Harbor®,  
 Sonoma,  
 Croft & Barrow®  
 and more.  
 orig. \$14-\$60,  
 sale 9.80-  
 42.00  
 SONOMA  
 life+style™.



■ apt.9

petites'

Entire Stock  
**30-40%**  
 off

Women's sportswear  
 from daisy fuentes®,  
 apt. 9™, Sonoma,  
 Croft & Barrow®,  
 Sag Harbor® and  
 Notations. Sizes  
 1X-3X & 16W-24W.  
 orig. \$18-\$68,  
 sale 11.99-47.60



women's

**WIN** a trip for two to **Paris** and a  
**\$10,000 Kohl's shopping spree!**

Enter Kohl's Transformation  
 Nation Contest today.  
 Go to [transformationnation.com](http://transformationnation.com) for all the details.



**CHAPS**  
EST. 1978

**ONLY AT KOHL'S**

Classic, elegant and timeless, Chaps for Her is grounded in a tradition of style, quality and impeccable taste.

**30-40% off entire stock**  
on Chaps collection for misses

orig. 19.50-119.50, sale 12.99-82.99 \ selected items online W2880



**82<sup>99</sup>**  
Chaps quilted jacket  
orig. 119.50

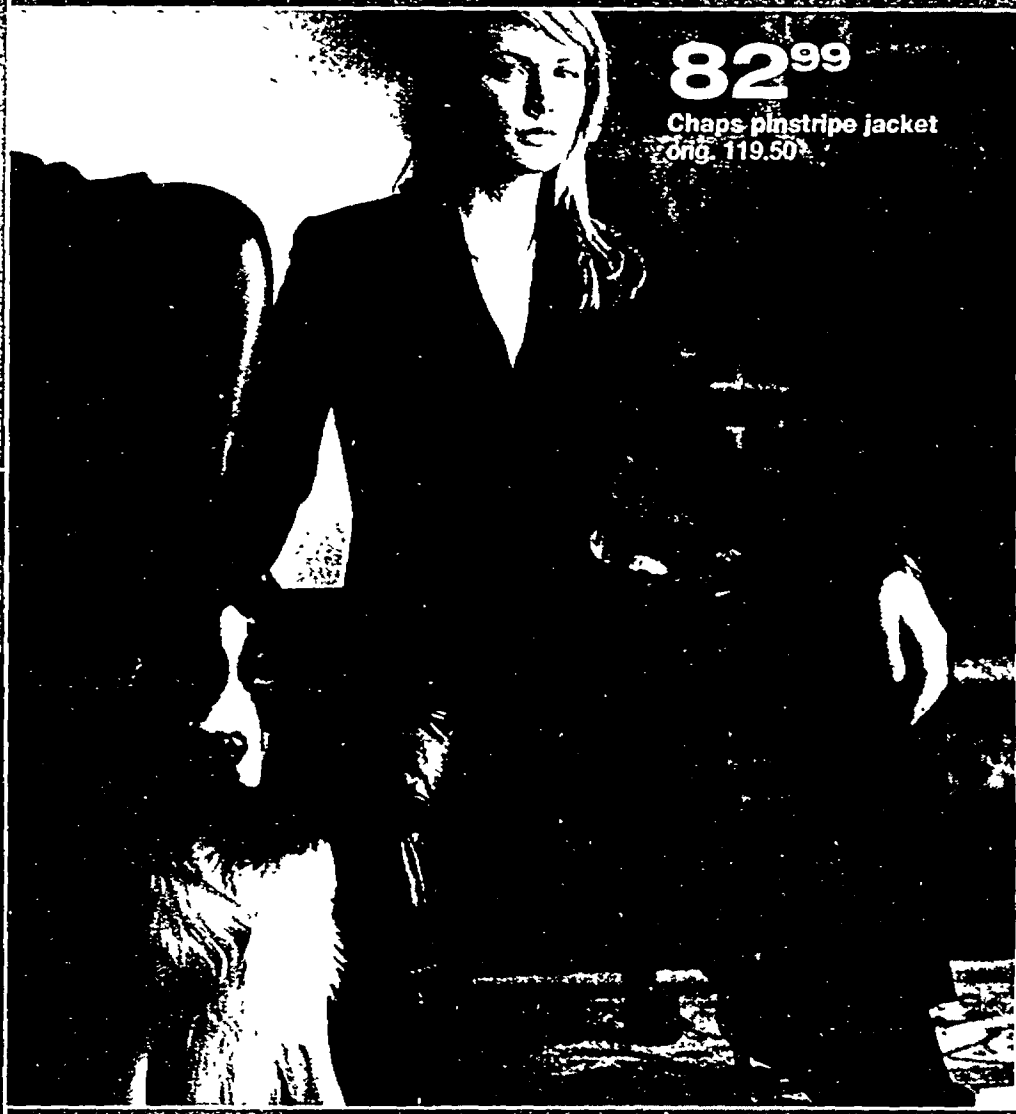

**82<sup>99</sup>**  
Chaps pinstripe jacket  
orig. 119.50



**47<sup>99</sup>**  
Chaps paisley skirt  
orig. 69.50

**30% off entire stock**  
Chaps handbags, handbag accessories, belts and socks

for Her. orig 7.00-98.50, sale 4.90-68.95 \ selected items online W2880



Chaps handbags & handbag accessories. orig. 22.50-98.50, sale 15.75-68.95



Chaps belts for Her. orig. \$28-\$32, sale 19.60-22.40

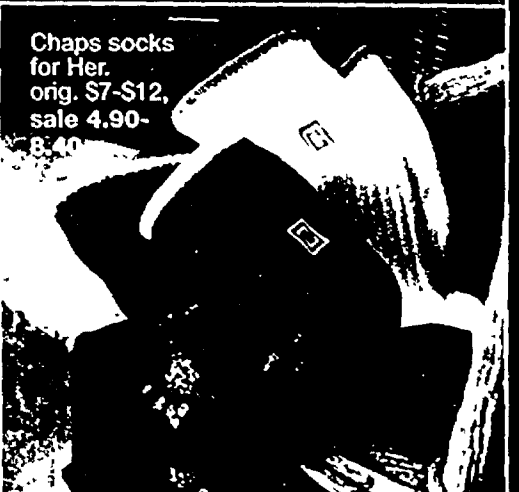

Chaps socks for Her. orig. \$7-\$12, sale 4.90-8.40

NO PURCHASE OR PAYMENT NECESSARY TO ENTER OR WIN, NOR WILL PURCHASE IMPROVE ONE'S CHANCES OF WINNING. Void outside the 50 United States, and Puerto Rico. Open only to legal residents of the 50 United States (excluding Puerto Rico) 18 years of age or older at time of entry. Employees of Kohl's and its affiliated companies and the immediate family members of each are ineligible to enter or win prize. Subject to Official Rules available online at [www.transformationnation.com](http://www.transformationnation.com), or via mail by sending a self-addressed stamped envelope to "Kohl's Transformation Nation Contest" (Rules), PO Box 902, Bayonne, NJ 07002. You may enter online at [www.transformationnation.com](http://www.transformationnation.com) by clicking on the Contest link and completing the required fields, or via mail by hand-printing your name, street address, city, state, ZIP code, and daytime phone number on a 3x5" card or piece of paper and mailing in a separate envelope to: "Kohl's Transformation Nation Contest" Entries, P.O. Box 709 Bayonne, NJ 07002. Participation in the Contest requires the submission of an essay and a photograph. Mail-in entries must be postmarked by 09/15/06, and received by 09/21/06. All entries must be complete to be eligible. First Prize (10): Trip for one (1) to attend a celebrity hosted fashion event in Los Angeles ARV: \$3,500 for each prize. Grand Prize (1) Trip for two (2) to Paris France and a \$10,000 Kohl's Shopping Spree. ARV: \$15,000 Total value of all prizes is \$50,000. See Official Rules for all details, terms and conditions. Contest begins on August 8, 2006 and ends on September 15, 2006.

**18<sup>99</sup>**

Olga® Best of Elegance™ bras reg. \$29



**33% off entire stock bras**  
 from Olga, Playtex®, Lily of France®, Bali®, Vanity Fair®,  
 Warners®, Maidenform® and Barely there®

**16.99**

Playtex® Secrets® Signature floral bra. reg. 26.50

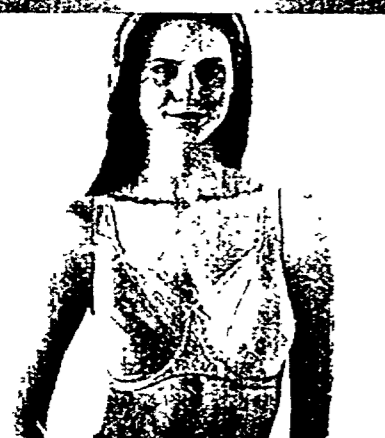

**17.99**

Lily of France® Dazzler™ push-up bra. reg. \$28



**18.99**

Bali® No Poke™ bras. reg. \$29-\$30



**19.99**

Vanity Fair® Soft N' Smooth™ contour underwire. reg. \$30



SONOMA LIFESTYLE

Entire Stock

**30-40% off**

Sleepwear, loungewear and robes for her. orig. \$12-\$52, sale 8.40-\$36.40  
 selected items online W2400

Warner's® Sheer Heaven™



Entire Stock

**33% off**

Panties, innerwear & shapewear reg. 3/\$15 to \$51 ea., sale 3/10.05 to 34.17 ea. Excludes Jockey® and bra coordinates.

**25-30% off fashion jewelry**

orig. \$8-\$32, sale 5.60-\$24.00 Selected styles. selected items online F999

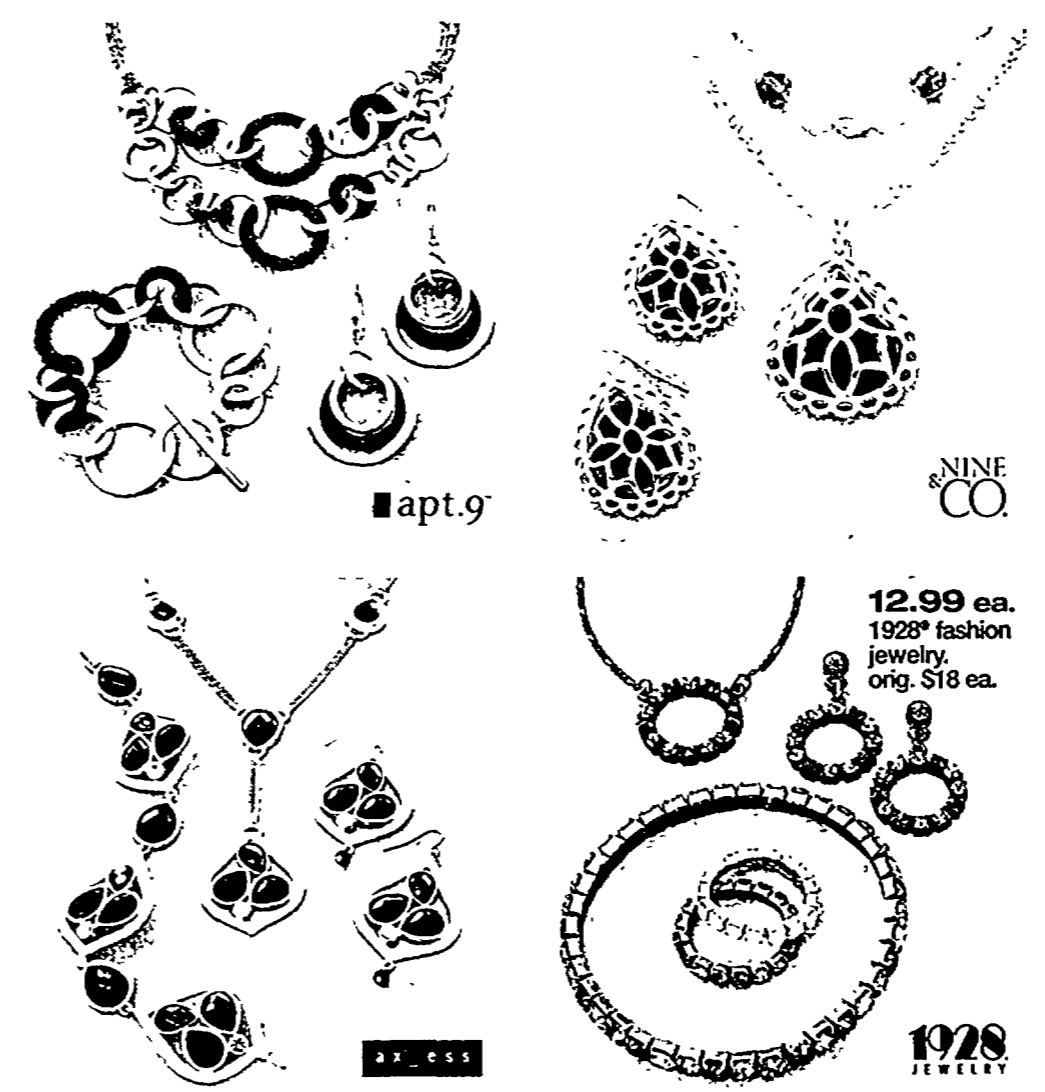

apt.9

NINE CO.

12.99 ea. 1928® fashion jewelry. orig. \$18 ea.

1928 JEWELRY

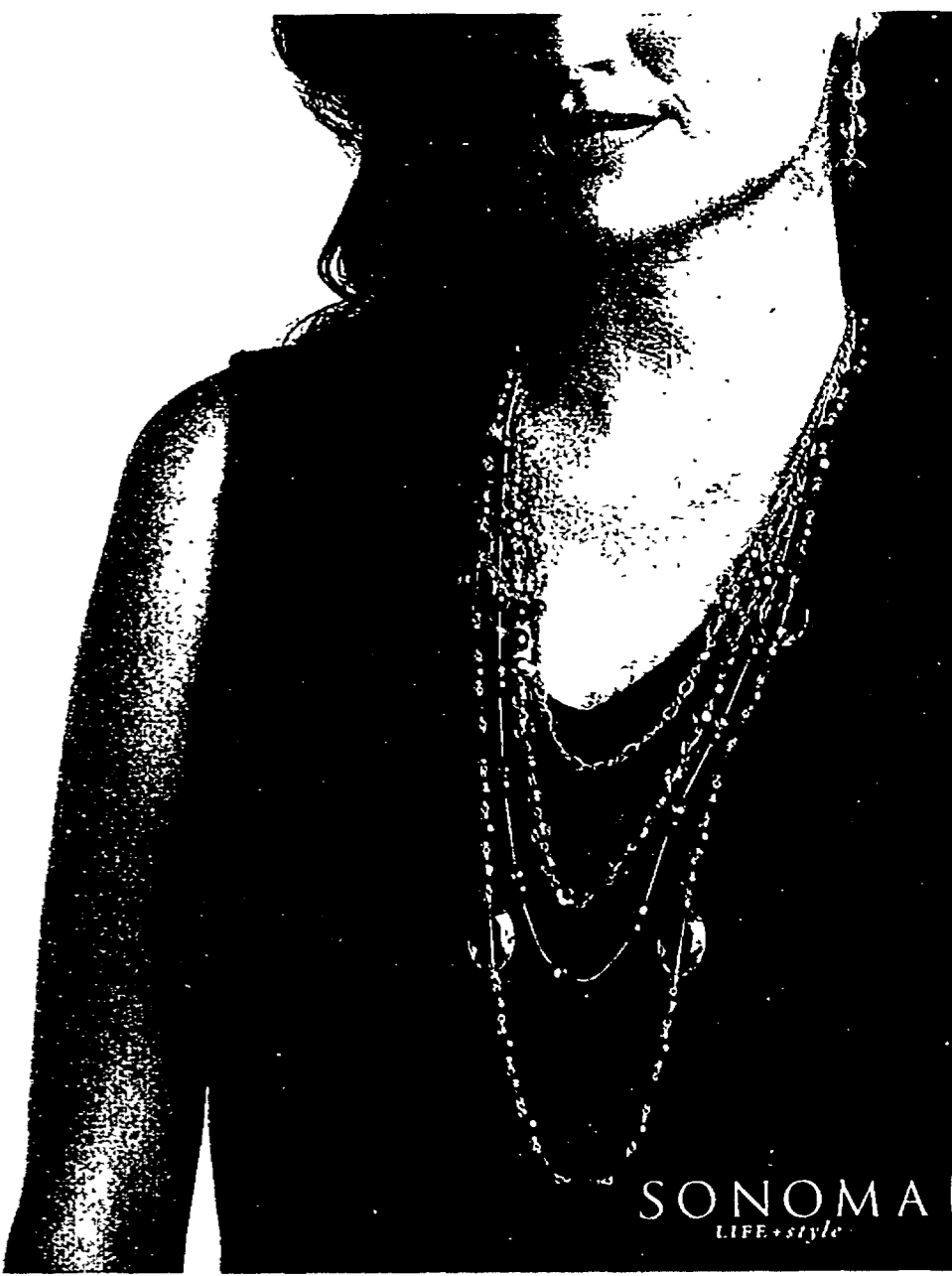

SONOMA LIFE+style

**25-40% off entire stock watches**

reg. 19.95-\$650.00, sale 14.96-\$487.50 selected items online F999

47.99 ea. Your choice Relic® Wet watch. reg. \$65 ea.

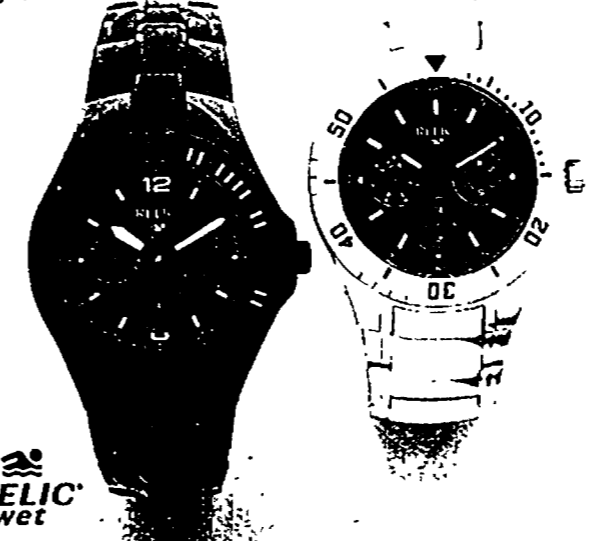

RELIC® wet

44.99 Men's Armitron® polished black dress watch. reg. 59.99

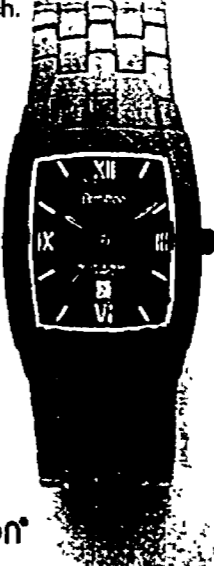

Armitron®

39.99 ea. Your choice ladies' Nine & Co.® dress watch. reg. \$55 ea.

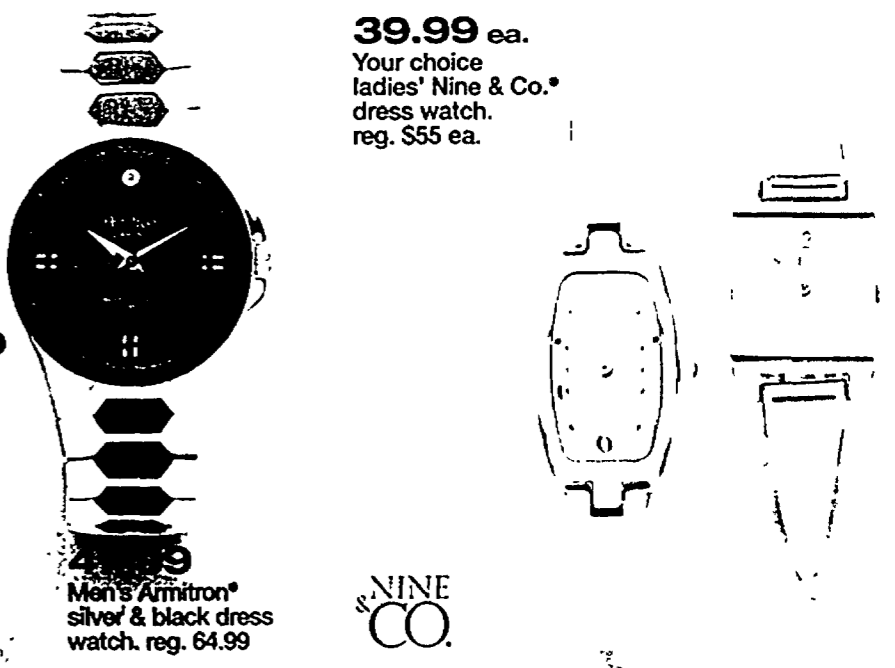

NINE CO.

**save an extra 15%**

on everything in store & online every time you use your Kohl's Charge Thurs.-Tues., Sept. 14-19, 2006  
 Save on all sale, regular, and clearance-priced merchandise. Subject to credit approval. See page 29 for details.



**18<sup>99</sup>**

Olga® Best of Elegance™ bras reg. \$29



**33% off entire stock bras** from Olga®, Playtex®, Lily of France®, Bali®, Vanity Fair®, Warners®, Wardenform® and Barely There® reg. \$17-\$29, sale 11.30-20.99 selected items online W1800

**16.99**

Playtex® Secrets® Signature floral bra. reg. 26.50



**17.99**

Lily of France® Dazzler™ push-up bra. reg. \$28



**18.99**

Bali® No Poke™ bras. reg. \$29-\$30



**19.99**

Vanity Fair® Soft N' Smooth™ contour underwire. reg. \$30



SONOMA LIFESTYLE

Entire Stock

**30-40% off**

Sleepwear, loungewear and robes for her. orig. \$12-\$52, sale 8.40-36.40 selected items online W2400

Warners® Sheer Heaven™



Entire Stock

**33% off**

Panties, innerwear & shapewear reg. 3/\$15 to \$51 ea., sale 3/10.05 to 34.17 ea. Excludes Jockey® and bra coordinates.

**25-30% off fashion jewelry**

orig. \$8-\$32, sale 5.60-24.00 Selected styles. selected items online F999



apt.9

NINE & CO.

12.99 ea. 1928® fashion jewelry. orig. \$18 ea.

1928 JEWELRY



SONOMA LIFE+style

**25-40% off entire stock watches**

reg. 19.95-650.00, sale 14.96-487.50 selected items online F999

47.99 ea. Your choice Relic® Wet watch. reg. \$65 ea.



RELIC® WET

44.99 Men's Armitron® polished black dress watch. reg. 59.99



Armitron®

39.99 ea. Your choice ladies' Nine & Co.® dress watch. reg. \$55 ea.

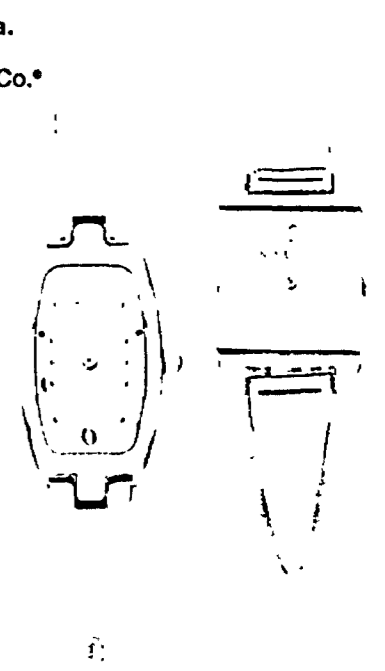

NINE & CO.

save an extra **15%**

on everything in store & online every time you use your Kohl's Charge Thurs.-Tues., Sept. 14-19, 2006 Save on all sale-, regular- and clearance-priced merchandise. Subject to credit approval. See page 29 for details.

# 50-60% off all fine & sterling silver jewelry

Some jewelry photos enlarged to show detail. Diamond total weights are approximate. T.W. may vary up to 10%. Actual savings may exceed the percent savings shown. Selected items online F989

INTRODUCING  
**JOURNEY**  
DIAMOND JEWELRY.  
WITH EVERY STEP,  
LOVE GROWS.



**129.99 ea.**  
Your choice  
1/4 ct. T.W. Journey  
graduated diamond  
jewelry. 10k gold.  
reg. \$325 ea.

**69.99 ea.**  
**Super Buy**  
Entire stock gemstone  
& diamond accent  
circle pendants. 10k  
gold. reg. \$200 ea.

**89.99 ea.**  
**Super Buy**  
Entire stock gemstone  
pendants. 10k gold.  
reg. \$275 ea.

**99.99 ea.**  
**Super Buy**  
Entire stock 1/4 ct.  
T.W. diamond circle  
pendants. 10k gold.  
reg. \$300 ea.

**29.99 pr. Super Buy**  
1/8 ct. T.W. diamond  
solitaire earrings.  
14k gold. reg. \$100 pr.

**84.99 pr.**  
1/4 ct. T.W. princess  
cut or round diamond  
solitaire earrings.  
14k gold. reg. \$250 pr.

**269.99 pr.**  
1/2 ct. T.W. princess  
cut or round diamond  
solitaire earrings.  
14k gold. reg. \$750 pr.

**749.99 pr.**  
1 ct. T.W. princess cut  
or round diamond  
solitaire earrings.  
14k gold. reg. \$2,000 pr.

**Super Buy**  
**99.99 ea.**  
Entire stock  
1/4 ct. T.W.  
diamond jewelry  
10k gold. reg. \$300 ea.

**Entire Stock**  
**59.99 ea.**  
Gemstone  
circle pendants  
10k gold.  
reg. \$150 ea.

**12.49 ea.**  
Sterling silver rings  
reg. \$25 ea.

**Entire Stock**  
**49.99 ea.**  
Diamond accent  
pendants  
10k gold.  
reg. \$125 ea.

**Entire Stock**  
**36.99 pr.**  
14k gold earrings  
reg. \$95 pr.

**Your Choice**  
**12.49 ea.**  
Sterling silver  
earrings or pendant  
reg. \$25 ea.

**Entire Stock**  
**30% off**

Handbags, minibags  
& handbag accessories  
orig. 10.00-98.50,  
sale 7.00-68.95  
selected items  
online W1600



apt.9

**Entire Stock**  
**30% off**

Fashion accessories  
and sunglasses  
orig. \$8-\$40,  
sale 5.60-28.00  
Accessories dept.



villager

**Entire Stock**  
**25-40% off**

Socks & slippers  
for her. orig. \$5-\$20,  
sale 3.50-14.00



SONOMA

**Entire Stock**  
**25-35% off**

Hosiery  
from Hanes®  
& Hanes Too!®.  
reg. 3.75-19.00,  
sale 2.43-14.25

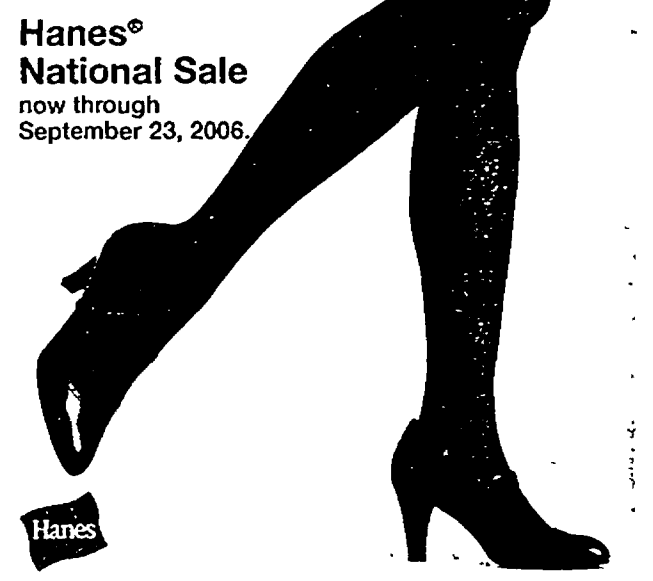

Hanes

## SAVE 10% ON ALL BEAUTY

fragrances, cosmetics, skincare from American Beauty, good skin, FLIRT & grassroots

introducing  
**American Beauty**  
wonderful indulgence™ fragrance

**\$32.99** reg. \$37.50  
**1.7-oz. perfume spray**  
The wonderful new fragrance  
that's irresistibly sensual.

"Treat yourself to a little  
indulgence."  
—Ashley Judd for American Beauty

**ONLY AT KOHL'S**  
AMERICAN BEAUTY

**FLIRT**

KOHL'S

# save an extra 15%

on everything in store & online every time you use  
your Kohl's Charge Thurs.-Tues., Sept. 14-19, 2006  
Save on all sale-, regular- and clearance-priced merchandise. Subject to credit approval. See page 29 for details.

transform the fall guy

Entire Stock  
**40% off**

Suit separates  
for men  
from Chaps,  
access and apt. 9".  
reg. \$75-\$220,  
sale \$45-\$132

Entire Stock  
**109<sup>99</sup>**

Chaps microsuede  
sport coats  
for men. orig. \$200



CHAPS  
EST. 1978

Entire Stock  
**109<sup>99</sup>**

access sport coats  
for men. orig. \$200



access

Entire Stock  
**139<sup>99</sup>**

Chaps  
top coats  
for men



CHAPS  
EST. 1978

Entire Stock  
**40% off**

Neckwear for men  
from Chaps, access  
and apt. 9".  
orig. \$25-\$28,  
sale 15.00-  
15.99



CHAPS  
EST. 1978

Entire Stock  
**40% off**

Dress shirts  
for men from  
Chaps, access  
and apt. 9".  
orig. \$38-\$42,  
sale 22.80-24.99



CHAPS  
EST. 1978

CHAPS  
EST. 1978



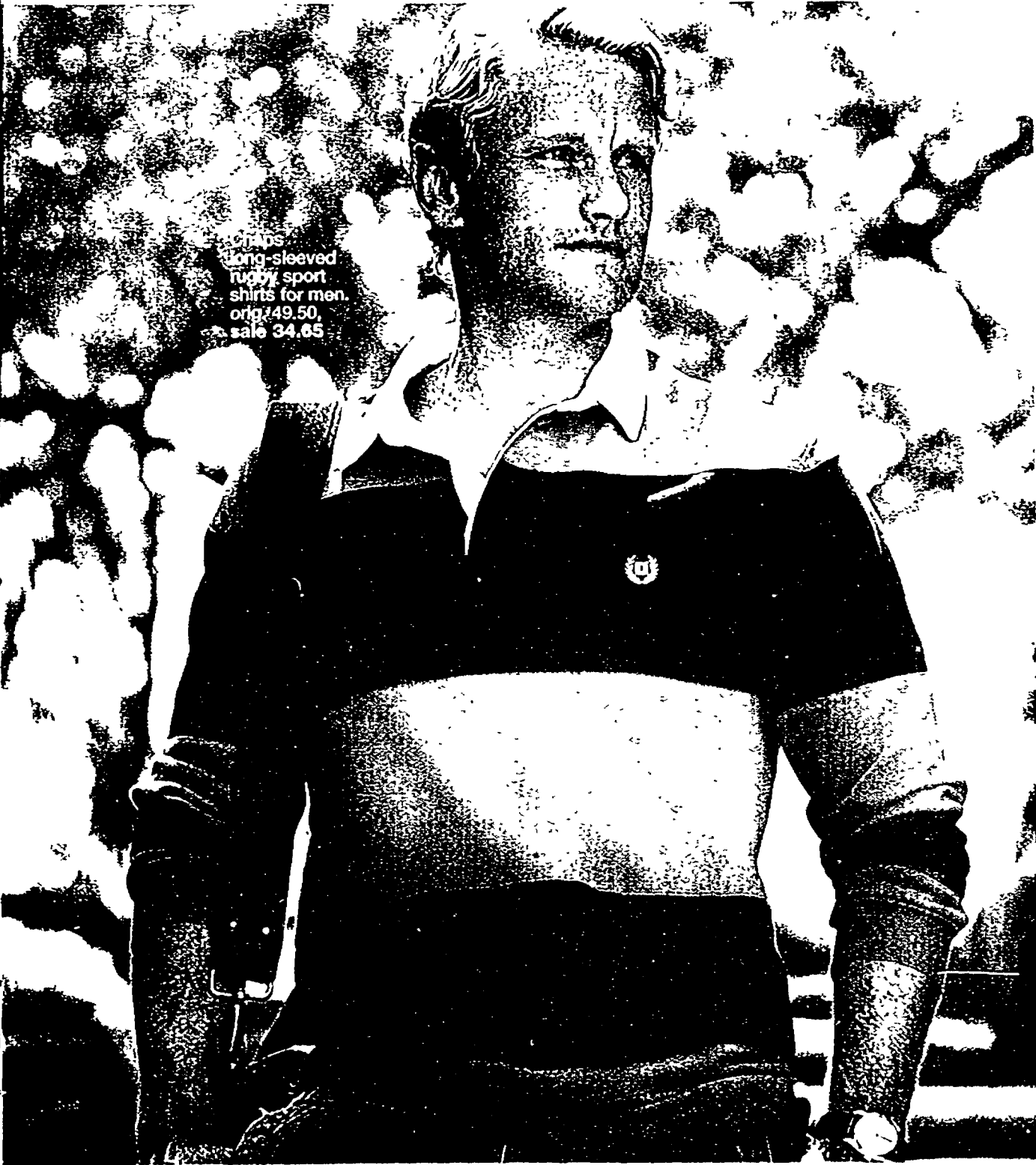

Chaps long-sleeved rugby sport shirts for men. orig. 49.50, sale 34.65

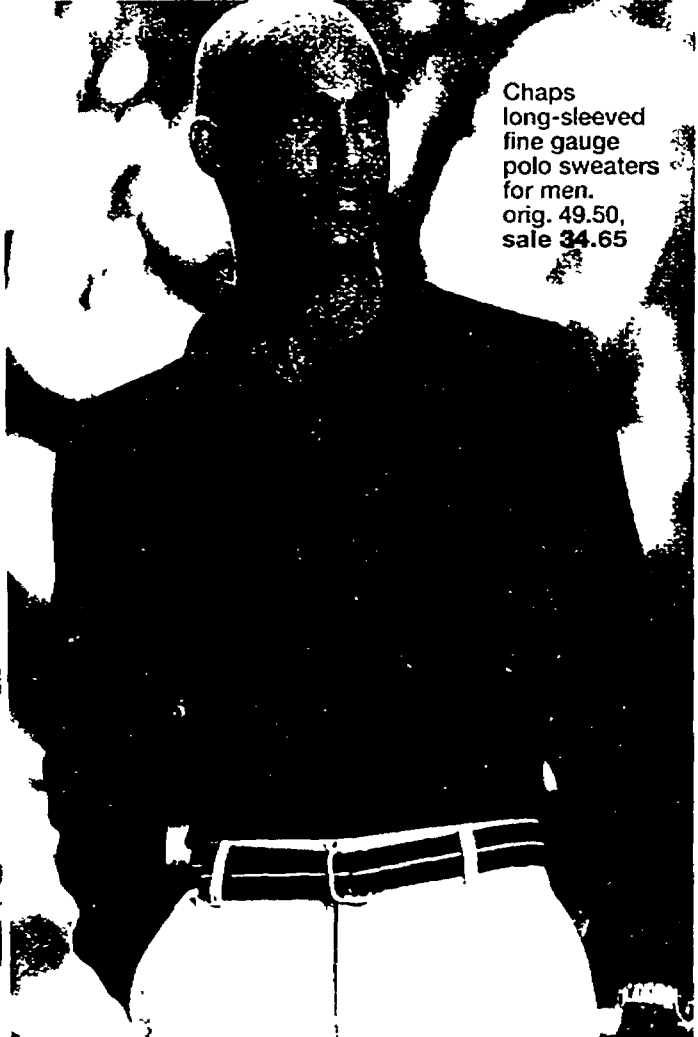

Chaps long-sleeved fine gauge polo sweaters for men. orig. 49.50, sale 34.65



Chaps colorblock jacket for men. orig. \$120, sale 79.99 Outerwear dept.

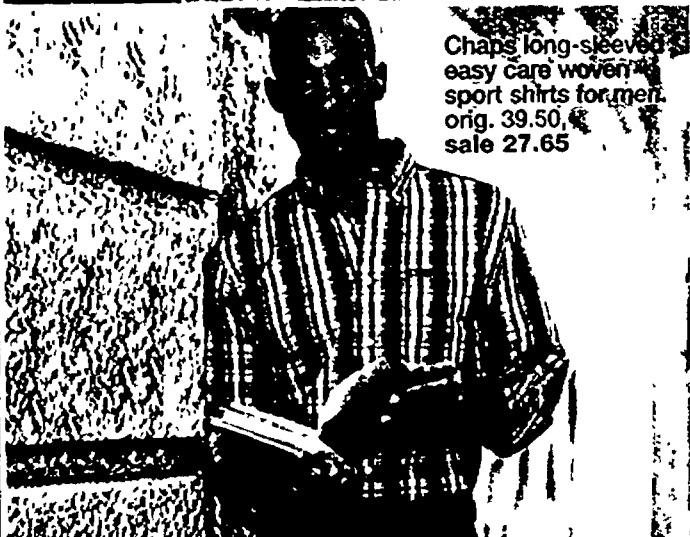

Chaps long-sleeved easy care woven sport shirts for men. orig. 39.50, sale 27.65



Chaps long-sleeved polo sport shirts for men. orig. 49.50, sale 34.65

transform the fall guy

Entire Stock  
**40% off**

Sport shirts for men  
from Sonoma, Arrow  
and Croft & Barrow.  
orig. \$24-\$40,  
sale 14.40-23.99



SONOMA  
LIFE style

Entire Stock  
**40% off**

Sweaters for men  
from Dockers® and  
Croft & Barrow®.  
orig. \$36-\$50,  
sale 21.60-29.99

selected items  
online P9137



DOCKERS  
DESTINATION

Entire Stock  
**40% off**

Knit tops for men  
from Sonoma,  
Croft & Barrow®  
and Arrow.  
orig. \$20-\$42,  
sale 11.99-25.20

selected items  
online P9138



SONOMA  
LIFE style

**21.99**

Entire stock  
Dockers®  
sport shirts  
for men.  
orig. \$38



DOCKERS  
DESTINATION

**21.99**

Entire stock  
Haggar® 2-in-1  
knit tops for  
men. orig. \$40



haggar

**29.99** entire stock  
Dockers® Original Khaki & Haggar®  
Comfort Equipped™ casual pants for men

Entire Stock  
**27<sup>99</sup>**

access long-sleeved  
patterned woven  
sport shirts  
for men. orig. \$45



access

Entire Stock  
**23<sup>99</sup>**

'Axist™ fashion and  
herringbone  
sport shirts  
for men. orig. \$40

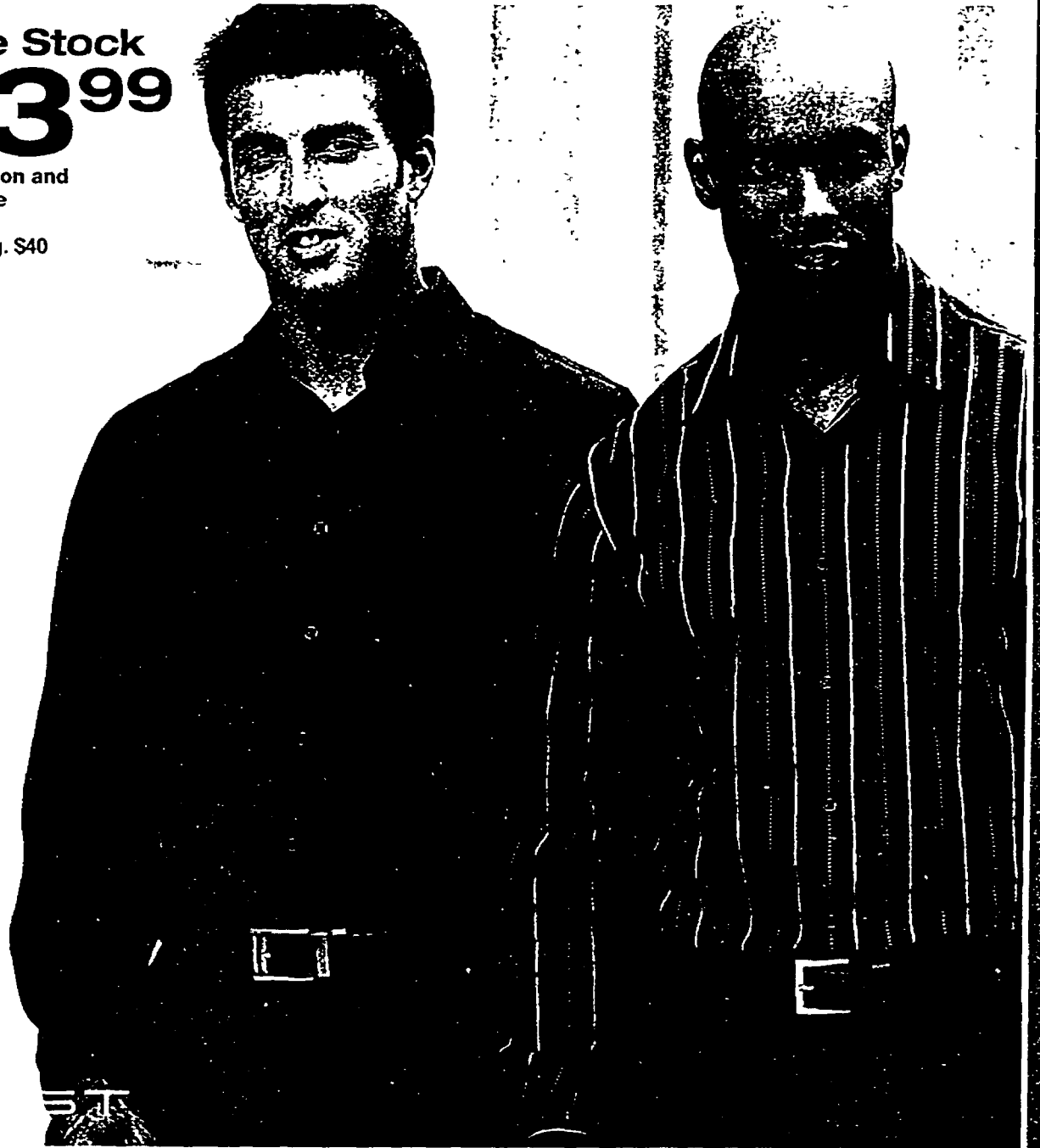

Entire Stock  
**21<sup>99</sup>**

Axist™  
drop-needle  
polo shirts  
for men.  
orig. \$40



AXIST

EI

Entire Stock  
**27<sup>99</sup>**

Axist™ polynotic  
sport shirts  
for men.  
orig. \$44



AXIST

E

Entire Stock  
**27<sup>99</sup>**

access long-sleeved  
solid textured  
sport shirts  
for men.  
orig. \$42

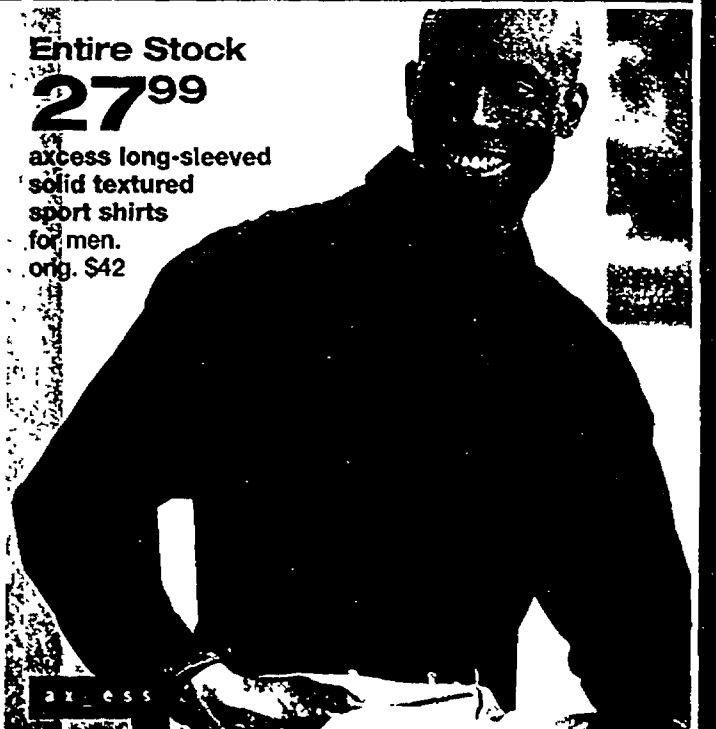

access

save  
**60-**  
**80%**

New markdowns  
 taken

We've  
 made it easy.

Final price  
 is marked  
 on the ticket.

We do the math.  
 You enjoy  
 the savings.

Clearance prices represent savings  
 off original prices. Sales may vary  
 by store. Final markdowns may  
 have been taken. Some price  
 adjustments given on one  
 purchase.

the new  
 gold star  
**clearance**

**30% off entire stock**

Hanes® Classics®, Sonoma and  
 Croft & Barrow® underwear

for men. reg. \$10-\$32, sale 7.00-22.40  selected items online P91310

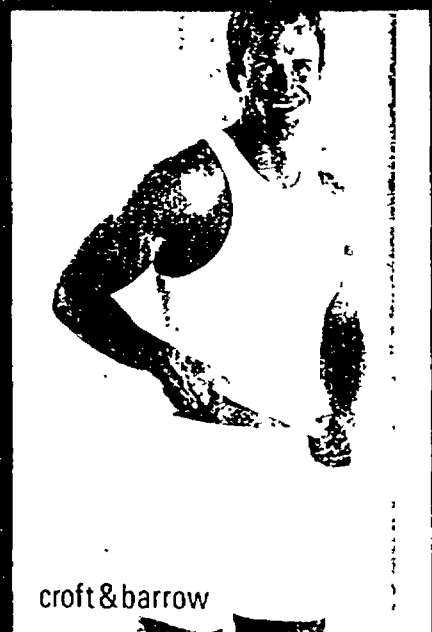
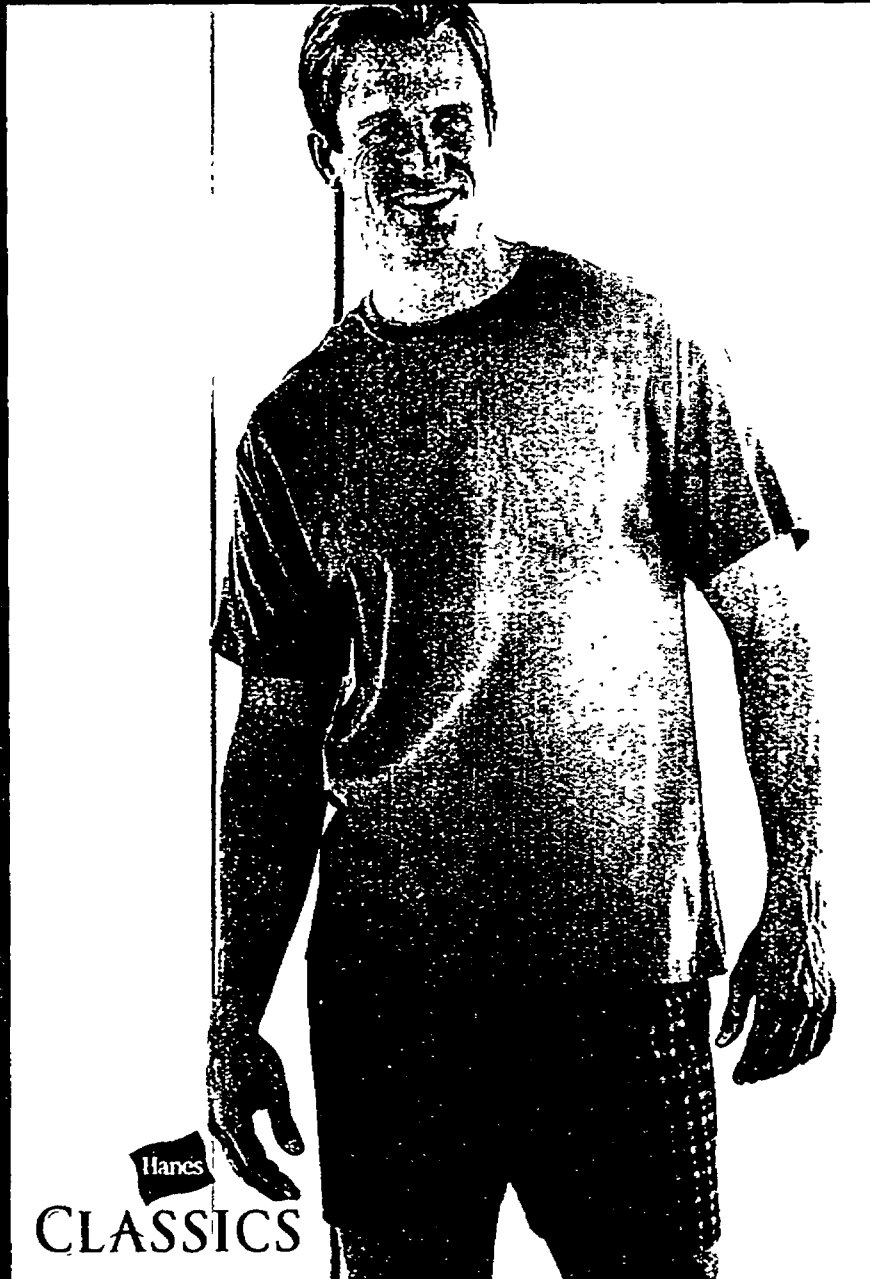

Entire Stock

**30% off**

Dress, casual  
 and athletic  
 socks for men.  
 reg. \$6-\$18,  
 sale 4.20-12.60

 selected items  
 online P91311



Entire Stock

**6.99**

Hanes®  
 pocket tees  
 for men. reg. \$12

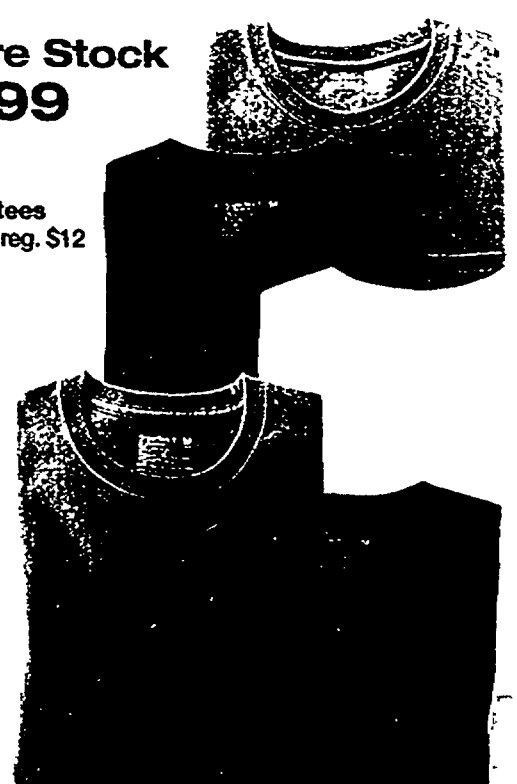

# BONNUS BOY

## SAVINGS



**Entire Stock**  
**50% off**  
 Knit tops for men  
 from Sonoma, Haggar®  
 and Croft & Barrow®.  
 orig. \$20-\$40,  
 sale 9.99-  
 19.99  
 selected  
 items  
 online  
 P91312

**50% off**  
 Sweaters  
 for juniors.  
 orig. \$24-\$30,  
 sale \$12-\$15  
 Selected  
 styles.

**Entire Stock**  
**30% off**  
 Watches by Pulsar®,  
 Seiko®, Citizen & Bulova.  
 reg. 79.50-650.00,  
 sale 55.65-455.00  
 shop online F999

**28<sup>99</sup>**  
 Reebok®  
 athletic shoes  
 for men  
 and women.  
 orig. 49.99  
 Selected  
 styles.



SONOMA  
 LIFE style  
 ONLY AT KOHL'S





barrow

**40-50% off**

Croft & Barrow®, Chaps, Sag Harbor®, Requirements® & West End sportswear for misses, petites & women. orig. 14.00-119.50, sale 7.99-70.99 Selected styles.



apt 9

**40-50% off**

apt. 9" sportswear for misses, petites & women. reg. \$20-\$48, sale 9.99-27.99 Selected styles.



ene

**50-60% off**

Knit tops for juniors. orig. \$16-\$20, sale 7.20-10.00 Selected styles.



SO

Entire Stock  
**14<sup>99</sup>**

SO... 5-pkt. Jeans for juniors. reg. 29.99  
selected items online P9135



Mudd Excludes bra coordinates.

Entire Stock  
**40% off**

Panties & Innerwear from Mudd®, Le.i®, St. Eve®, Maidenform® & Vanity Fair®. reg. 3/\$15 to \$16 ea., sale 3/9.00 to 9.00 ea.

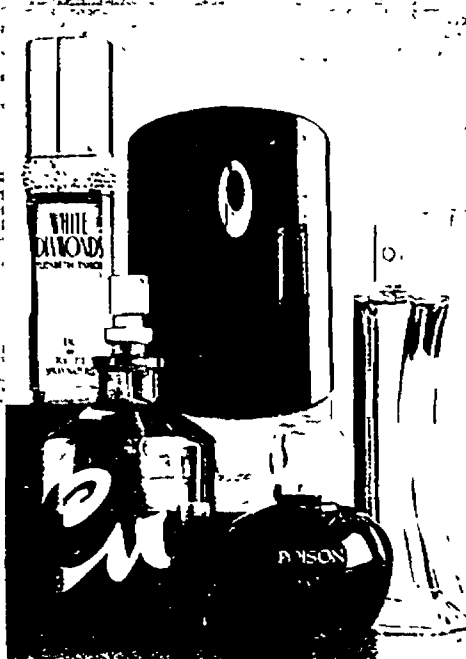

Entire Stock  
**10% off**

Fine fragrances reg. 4.50-70.00, sale 4.05-63.00  
selected items online P91317



**39.99 Super Buy**  
1/4 ct. T.W. diamond hoop earrings. Sterling silver. reg. \$125

**129.99 Super Buy**  
1 ct. T.W. diamond interchangeable double circle pendant. Sterling silver. reg. \$375

Entire Stock  
**60% off**

Diamond, gemstone and pearl jewelry  
shop online F999



Entire Stock  
**60% off**

Gold jewelry reg. \$65-\$650, sale 25.99-259.99  
shop online F999

Entire Stock

**50% off**

Wrinkle-free sport shirts for men from Arrow and Croft & Barrow®. orig. \$34-\$40, sale \$17-\$20  
ARROW

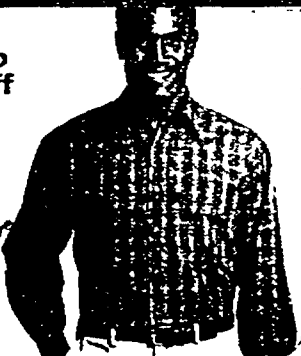

Entire Stock

**40% off**

Outerwear for men from Sonoma & Croft & Barrow®. orig. \$60-\$300, sale \$36-\$180  
SONOMA



Entire Stock

**50% off**

Russell® Athletic NCAA fleece hoodie and tee combo pack for men. orig. \$40, sale \$20  
Styles & schools vary by store.



Entire Stock

**9<sup>99</sup>**

Graphic tees for young men. orig. \$18  
Excludes collections.



Entire Stock

**50% off**

Sleepwear for boys 4-20, girls 4-16, toddlers & infants.



Entire Stock

**40% off**

Jumpers and dresses for toddlers, infants, newborns and girls 4-16.



**30% off**

Athletic shoes for the family from Nike® and New Balance®. reg. 39.99-65.00, sale 27.99-44.99  
Selected styles.  
NIKE new balance



Entire Stock

**40-50% off**

Shoes & boots for the family from Sonoma, Croft & Barrow® and SO... orig. 29.99-99.99, sale 17.99-59.99



Entire Stock

**40-50% off**

Dress shirts and neckwear for men from Arrow, Croft & Barrow® and Axiist®. orig. \$25-\$46, sale 15.00-27.60  
shop online P91380  
ARROW



Entire Stock

**50% off**

Casual pants for men from Axiist®, Sonoma and Croft & Barrow®. orig. \$40-\$45, sale 20.00-22.50  
Selected styles.  
AXIIST

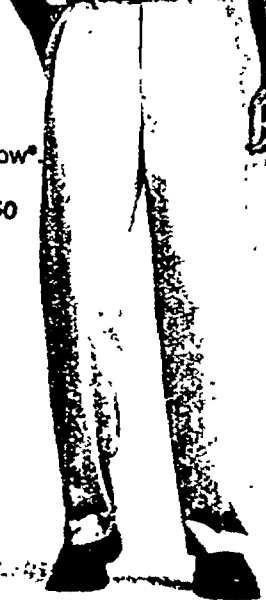

Entire Stock

**12<sup>99</sup>**

Sonoma Regular and Relaxed Fit jeans for men. reg. 24.99  
shop online P91379  
SONOMA



Entire Stock

**12<sup>99</sup>**

Urban Pipeline™ basic cargo pants for young men. orig. 29.99  
Urban Pipeline



Entire Stock

**50% off**

Graphic tees for boys 8-20. orig. \$12-\$18, sale \$6-\$9  
Excludes athletic & collections.  
selected items online P91318



Entire Stock

**40% off**

Playwear for girls 4-6x, boys 4-7 and toddlers from Healthtex® and Carter's®. Playwear not intended as sleepwear.  
Healthtex

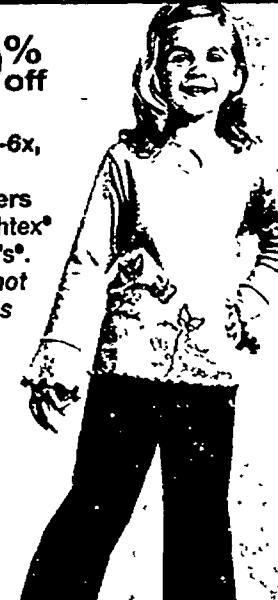

Entire Stock

**40% off**

Outerwear for girls 4-16, boys 4-20, toddlers, infants and newborns.  
Excludes Columbia Sportswear Company® and athletic.

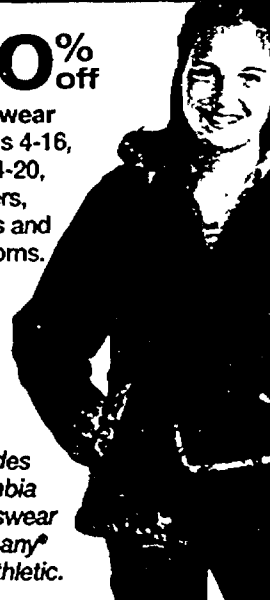

KOHL'S

save an extra **15%**

on everything in store & online every time you use your Kohl's Charge Thurs.-Tues., Sept. 14-19, 2006

Save on all sale-, regular- and clearance-priced merchandise. Subject to credit approval. See page 29 for details.

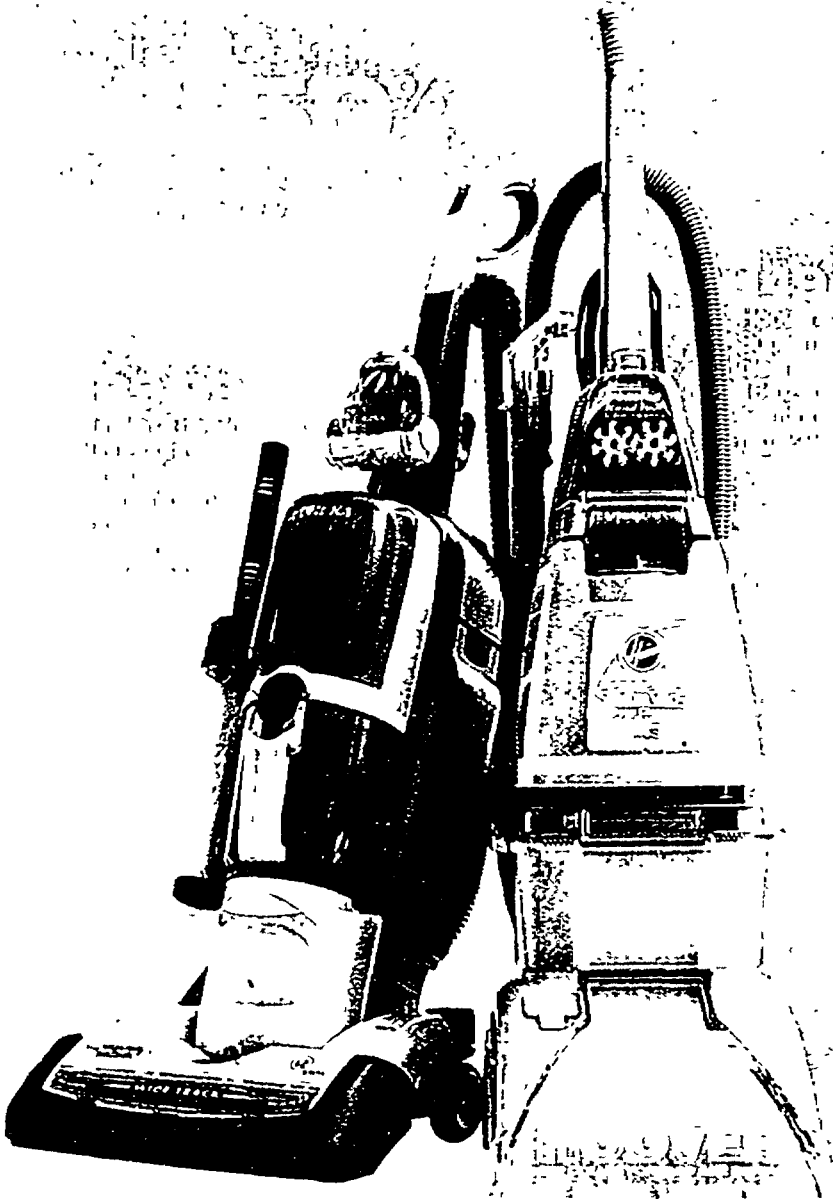

Entire Stock  
**15-50%** off

Personal care

**17.99**

Your choice  
Remington® Ion Glow  
hair styler or Taylor  
digital lithium scale.  
orig. 24.99 or 29.99 ea.



**49.99**

Oversized  
cherry  
TV tray  
5-pc. set  
reg. 99.99



Entire Stock

**9.99**

DVDs  
reg. 16.99



**59.99**

Farberware®  
Provisions 10-pc.  
stainless steel  
cookware set  
reg. 119.99



FARBERWARE

**79.99**

Stratus 5-pc.  
luggage set  
Includes three  
uprights—20", 24",  
27", rolling tote &  
toiletry kit. Also  
available in black.  
reg. 199.99

STRATUS

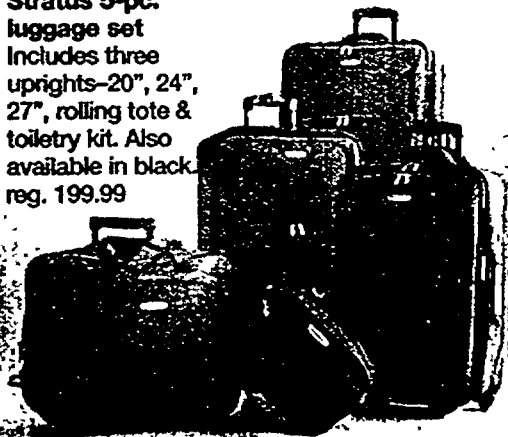

Entire Stock

**50%** off

Bed in one  
bag sets  
Set includes  
comforter,  
sham(s),  
coordinating  
sheet set  
& bedskirt.  
orig. 89.99-  
269.99,  
sale 44.99-  
134.99



Entire Stock

**50%** off

Quilts and  
coordinating  
accessories  
orig. 34.99-  
199.99,  
sale 17.49-  
99.99



All Sizes

**39.99**

Home Classics®  
slipcovers  
reg. 89.99



THE  
**BIG ONE**  
MATTRESS PAD

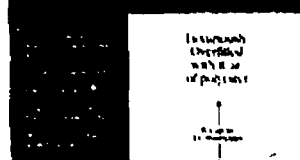

THE  
**BIG ONE**



STANDARD/QUIET™

Entire Stock  
**40% off**

Graphic fleece tops for young men.  
orig. \$46, sale 27.60  
Excludes collections.

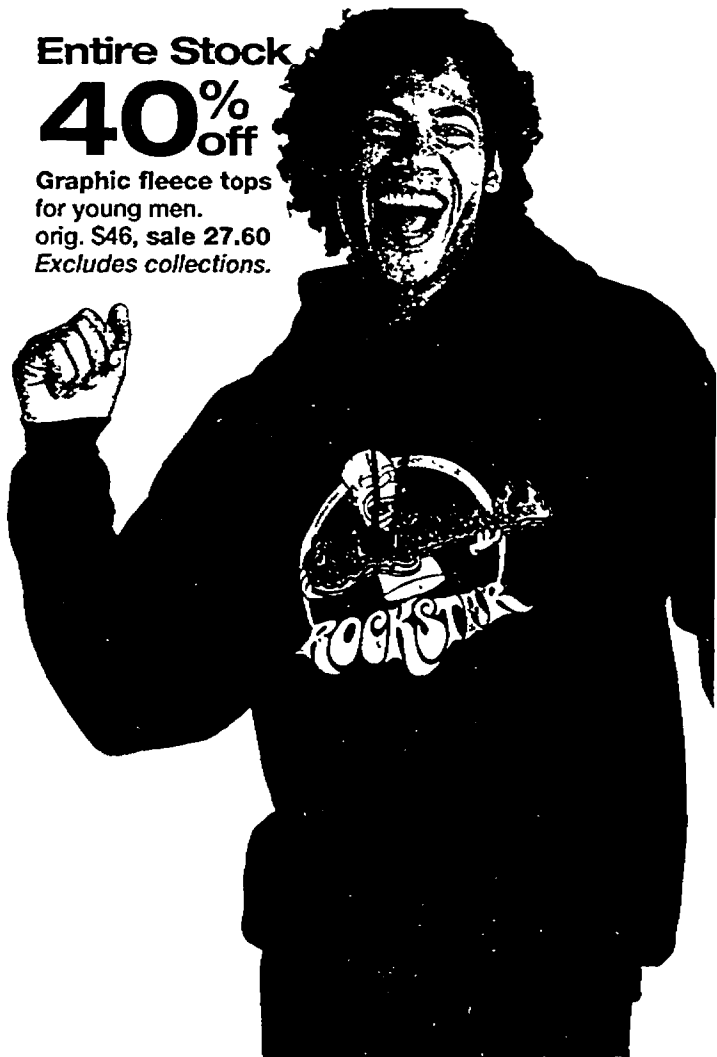

Entire Stock  
**40% off**

Long-sleeved woven tops for young men from Urban Pipeline™, Eighty Eight® and Dickies®.  
orig. \$38-\$50  
sale 19.99-30.00

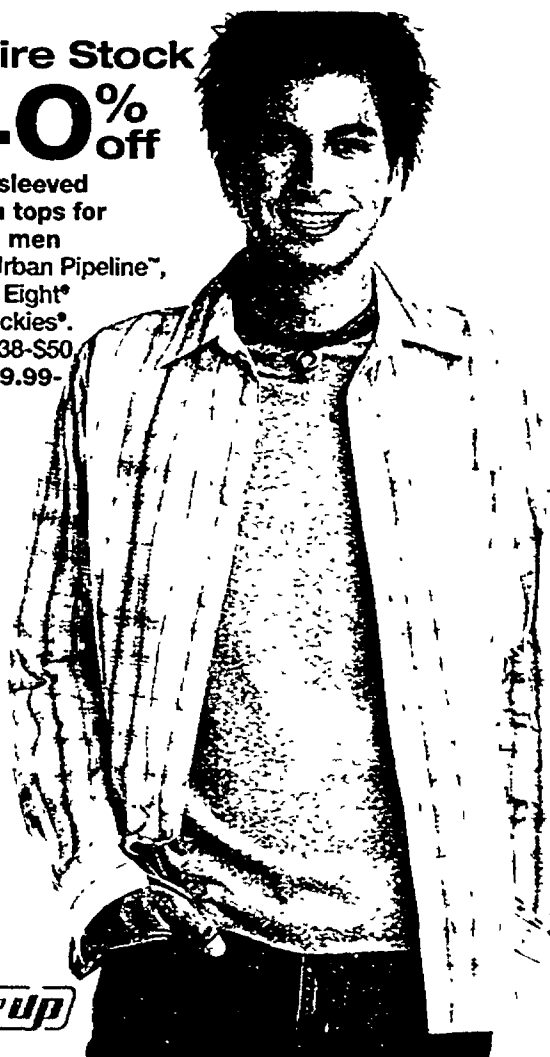

urban up

Entire Stock  
**19.99**

Urban Pipeline™ jeans & fashion cargo pants for young men.  
orig. 39.99  
selected items online P91325

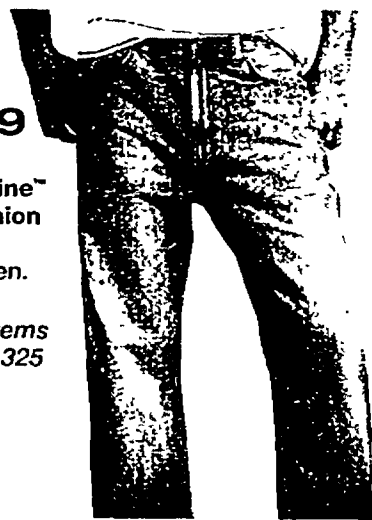

urban up

**24.99**

Jeans & pants for young men from Plugg®, U.S. Polo Assn., PACO® & Avirex®.  
orig. \$42-\$50



plugg

Entire Stock  
**40% off**

Long-sleeved knit tops for young men from XTreme Gear™, Urban Pipeline™ and Machine®.  
orig. \$24-\$42,  
sale 12.99-25.20

selected items online P91327

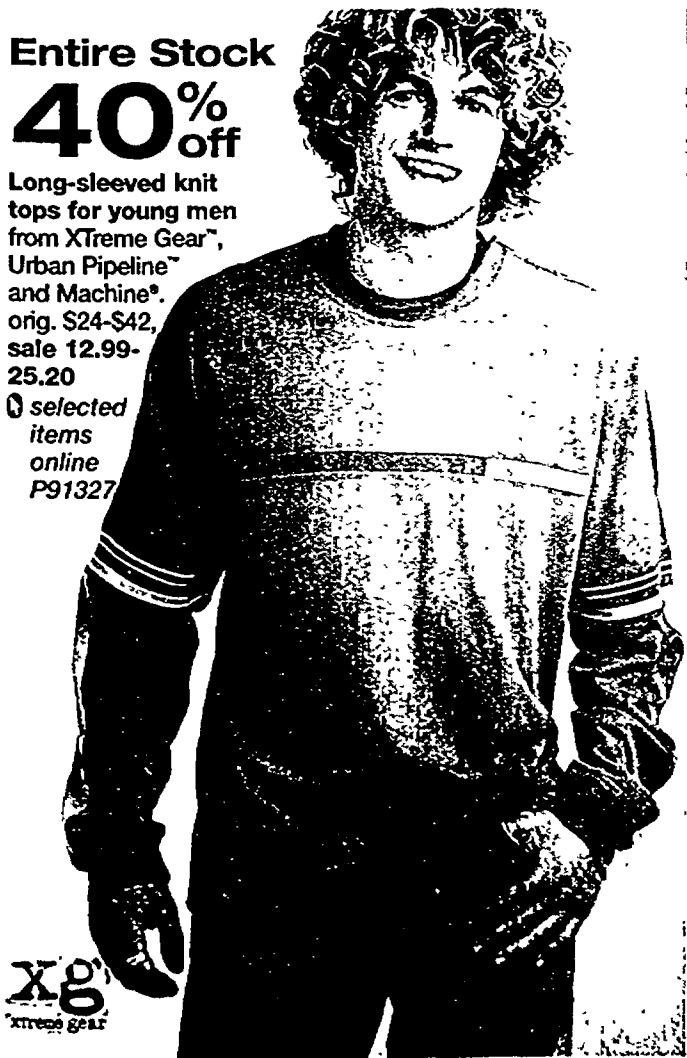

XTREME GEAR

Entire Stock  
**20-40% off**

Athletic apparel for men.  
orig. \$16-\$55,  
sale 9.99-44.00

selected items online P91324

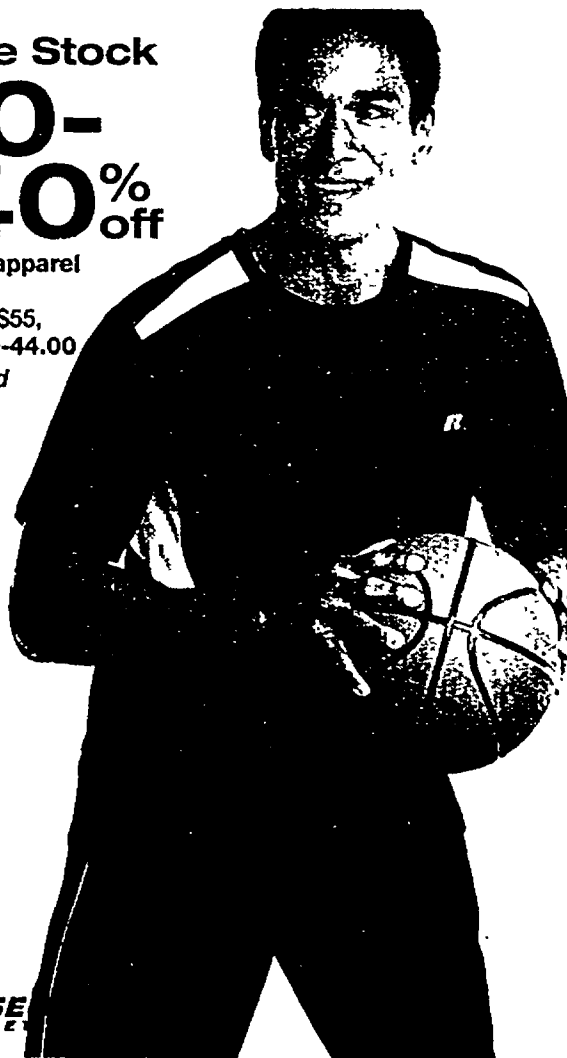

RUSSE

**24.99**

Jeans & pants for young men from Unionbay® & Lee® Dungarees.  
orig. 29.99-58.00



UNIONBAY

Entire Stock  
**19.99**

Lee® Regular Fit, Relaxed Fit and Relaxed Straight Fit jeans for men.  
selected items online P91326

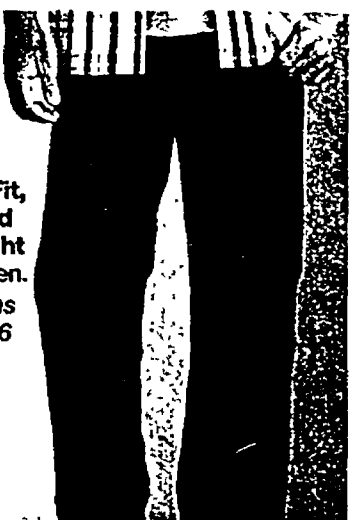

Lee

**holiday jobs**

Kohl's overnight or early morning part-time stocking positions offer flexible hours, extra cash for the holidays and earn you discounts on all our merchandise. Seasonal positions now available; see store for details. EOE

Candie's



**25-40% off entire stock**  
apparel for girls 4-16

Entire Stock **17.99**  
Levi's® Jeans for girls 4-6x. reg. 24.99

Entire Stock **19.99**  
5-pkt. denim jeans for girls 7-16 from GLO® and Levi's®. reg. \$29-\$30

Entire Stock **27.99**  
Candie's® denim jeans for girls 7-16. orig. \$38

**40% off entire stock**  
Urban Pipeline™ apparel for boys 8-20

**12.99**  
Urban Pipeline™ long-sleeved jersey skater tees for boys 8-20. orig. \$22

**15.99**  
Urban Pipeline™ woven 2-fer tops for boys 8-20. orig. \$28

**17.99**  
Urban Pipeline™ boot & den for boys 8-20. orig. \$28

**save an extra 15%**

Entire Stock **40% off**  
Fleece tops for boys 8-20. orig. \$32-\$36, sale 19.20-21.60. Excludes athletic & collections.

**20% off**  
Nike® athletic apparel for boys 8-20. orig. \$16-\$38, sale 12.80-30.40. Selected styles.

Entire Stock **40% off**  
Reebok® athletic apparel for boys 4-7. orig. \$28-\$36, sale 15.99-20.99. Excludes team apparel.

on everything in store & online every time you use your Kohl's Charge Thurs.-Tues., Sept. 14-19, 2006

Save on all sale-, regular- and clearance-priced merchandise. Subject to credit approval. See page 29 for details.

# 4 PAGES OF BONUSBUY SAVINGS

## save on all basics for boys

Excludes Jockey®. Selected items online P91321



**Entire Stock**  
**40% off**  
Sonoma lounge pants  
for boys 4-20, orig. \$16, sale 9.60



**Entire Stock**  
**30% off**  
Hanes® Classics®  
underwear  
for boys.  
reg. 7.99-10.99,  
sale 5.59-7.69



**Entire Stock**  
**30% off**  
Athletic socks  
for boys  
from Nike®  
& adidas®.  
reg. \$9-\$12,  
sale 6.30-8.40



**Entire Stock**  
**30% off**  
Sonoma  
underwear  
and socks  
for boys.  
reg. 7.50-12.00,  
sale 5.25-8.40



**Entire Stock**  
**25% off**  
Character  
briefs and  
boxer briefs  
for boys.  
reg. 7.99-10.00,  
sale 5.59-7.00



**Entire Stock**  
**40% off**  
Sleepwear  
for boys 4-20, orig. \$25-\$35, sale \$15-\$21

## save on all basics for girls

Excludes Jockey®. Selected items online P91322



**Entire Stock**  
**40% off**  
Dancewear  
for girls.  
orig. \$12-\$25,  
sale 7.20-15.00



**Entire Stock**  
**30% off**  
Tights for girls.  
reg. 3.50-12.00,  
sale 2.45-8.40



**Entire Stock**  
**25% off**  
Maidenform®  
bras for girls.  
reg. \$9-\$12,  
sale 6.75-9.00



**Entire Stock**  
**40% off**  
Sleepwear for girls.  
orig. \$22-\$35,  
sale 13.20-21.00



**Entire Stock**  
**30% off**  
Socks for girls.  
reg. \$4-\$15,  
sale 2.80-10.50



**Entire Stock**  
**40% off**  
Character  
underwear  
for girls.  
reg. \$8,  
sale 4.80

Shop Kohl's Monday-Saturday 8am-10pm  
and Sunday 10am-8pm

Store hours may vary; see back cover for details.

**KOHL'S**  
Kohl's Department Store

**b a b y s a l e**

save a bundle  
on everything baby

Entire Stock

**30% off**

Skechers® apparel  
for infants.



Entire Stock

**40% off**

Sonoma separates  
for toddlers.

selected items online  
P91333

SONOMA  
Lifestyle



Entire Stock

**25% off**

Nike® apparel  
for toddlers.



Entire Stock

**40% off**

First Moments®  
layette for newborns.  
Excludes packaged  
layette.

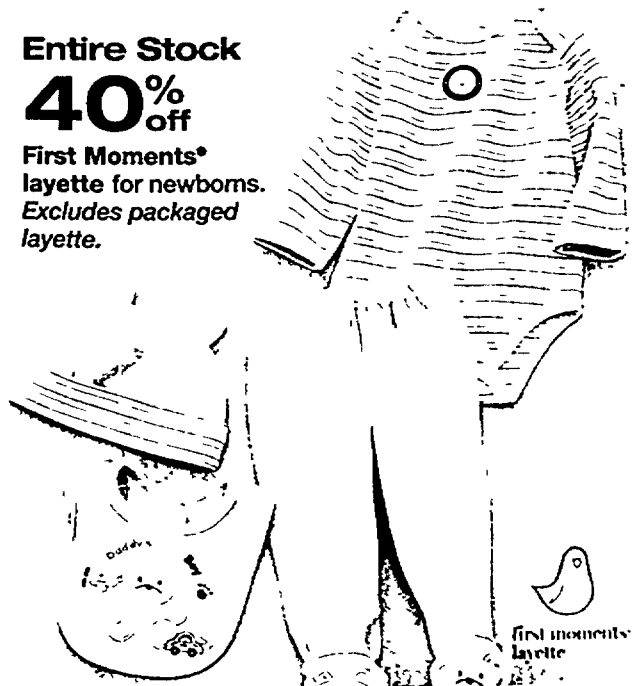

save  
**25-40%**  
on brands  
for infants  
and toddlers

Entire Stock

**30% off**

OSHKOSH®  
playwear  
for infants.  
Playwear not  
intended as  
sleepwear.



Entire Stock

**40% off**

Chaps apparel  
for infants and  
toddlers.



Entire Stock

**30% off**

Carter's® separates  
for infants.

selected items  
online P91334



Your Choice

**11.99**

Nike® gift sets  
for newborns.  
reg. \$18 ea.



**29.99**  
 Shoes for women  
 orig. 49.99  
 Selected styles  
 on sale 29.99

daisy fuentes  
 Scholar

apt. 9  
 Striker

apt. 9

daisy fuentes

**Entire Stock**  
**19.99**  
 Casual dress shoes for toddler boys and girls  
 orig. 24.99

Carter's  
 Seven

Carter's  
 Tracker

carter's

OSHKOSH  
 INSURE

OSHKOSH  
 INSURE

toddlers

**Entire Stock**  
**19.99**  
 Dress & casual shoes for toddler girls  
 orig. 24.99

OSHKOSH  
 Marigold

Carter's  
 Galaxy

carter's

OSHKOSH  
 INSURE

OSHKOSH  
 INSURE

toddlers

**29.99**  
 Shoes for men  
 orig. 49.99  
 Selected styles  
 on sale 29.99

villager  
 Lush

villager  
 croft & barrow

**30% OFF**  
 Boots for men  
 orig. 69.99 - 149.99  
 Selected styles  
 on sale 48.99

48.99

Mudd  
 Mudd  
 orig. 69.99

51.99  
 Nine & Co.  
 Ultimately,  
 orig. 74.99

SO

NINE & CO.

Mudd

croft & barrow

**49.99**  
 Shoes for men  
 orig. 69.99  
 Selected styles  
 on sale 49.99

Nunn Bush  
 Explorer

Nunn Bush  
 Dash

NI

SEMI-ANNUAL  
**SHOE SALE**

every style. every brand.

**29.99**  
 Classic sneakers  
 orig. 49.99  
 Selected styles  
 on sale 29.99

adidas

CONVERSE

**29.99**  
 Sneakers for women  
 orig. 49.99  
 Selected styles  
 on sale 29.99

SNEAKERS

**29.99**  
 Sneakers for women  
 orig. 49.99  
 Selected styles  
 on sale 29.99

new balance

Reebok

save on running shoes

49.99

adidas

39.99

NIKE

NIKE

**29.99**  
 Sneakers for women  
 orig. 49.99  
 Selected styles  
 on sale 29.99

AVIA

Reebok

**29.99**  
 Sneakers for women  
 orig. 49.99  
 Selected styles  
 on sale 29.99

VANS

every shoe. all on sale.

**25-50% off entire stock**  
comforter sets & coordinating accessories

**Twin Set 99.99**  
Comforter set by Villager. Includes comforter, bedskirt & sham. orig. 169.99. -230-thread count sheet sets & accessories available. -Also available in full-king orig. 29.99-269.99, sale 19.99-169.99

villager

**Queen Set 159.99**  
Comforter set by Nine & Co.\* orig. 269.99



**Queen or King Set 199.99**  
Comforter set by Park Avenue. orig. 279.99-299.99



**40-50% off entire stock**  
sheet sets *Excludes coordinating sheet sets.*  
selected items online P91337

**Twin Set 12.99**  
The Big One™ 250-thread count sheet sets. -Cotton/polyester blend -15 colors orig. 26.99 -Also available in full-king orig. 54.99-79.99, sale 29.99-39.99

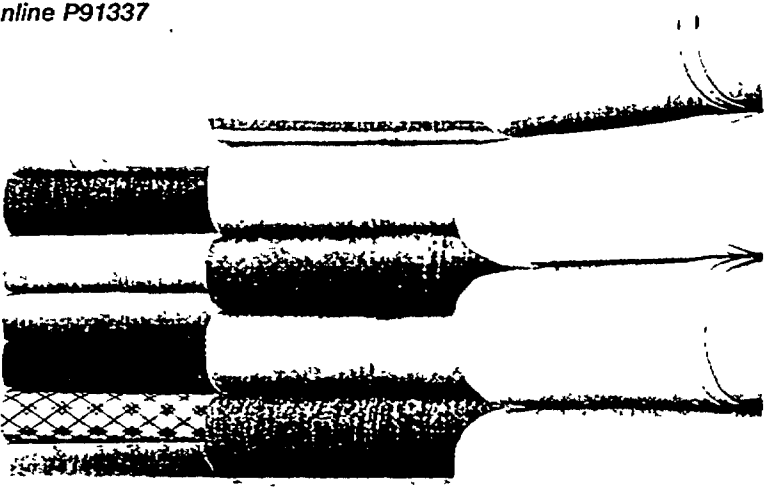

**Twin Set 29.99**  
apt. 9™ 350-thread count sheet sets. orig. 49.99

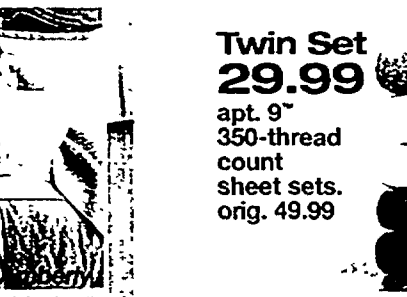

**Queen or King Set 69.99**  
600-thread count sheet sets by Luxury Collection. orig. 129.99-134.99



**40-50% off entire stock**  
solid bath towels & bath rugs  
selected items online P91338

**4.99**  
Martex® Pipeline bath towels. -100% cotton -27x52" bath reg. 9.99 -Hand towels & washcloths also available reg. 5.99-7.99, sale 2.99-3.99

**6.99**  
Sonoma Pima cotton towels. reg. 11.99

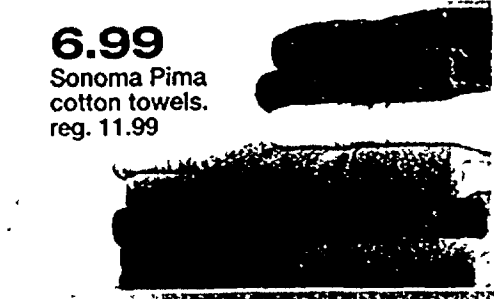

**9.99**  
ROYAL VELVET® Signature Supima bath towels. reg. \$18

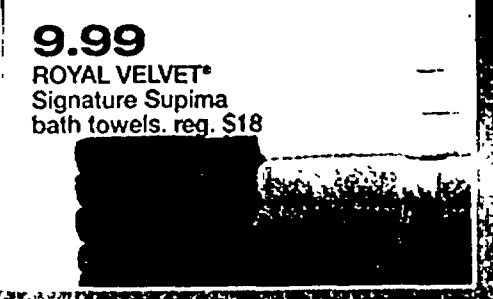

**35-50% off entire stock**  
bath coordinates, shower curtains & decorative bath accessories  
reg. 7.99-64.99, sale 5.19-42.24 selected items online H1130



**16.99**  
Windsor Court bath pump. reg. 26.99



**9.99**  
Rosecliff bath pump. reg. 19.99



**40-50% off entire stock**  
throws

**9.99**  
The Big One fleece throw. 60x70" orig. 19.99



**14.99**  
Microplush throw. 60x80" orig. 39.99



**24.99**  
Down throw. 55x65" orig. 49.99

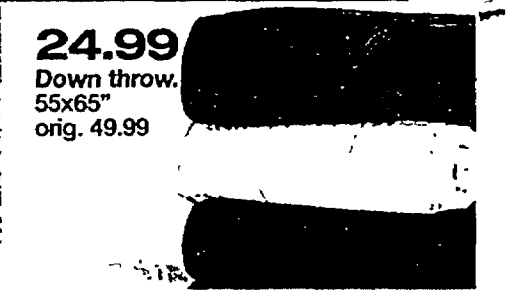

**40% off entire stock**  
table linens, placemats & kitchen textiles  
orig. 1.99-59.99, sale 1.19-35.99



**20.99**  
Sonoma microplush placemat

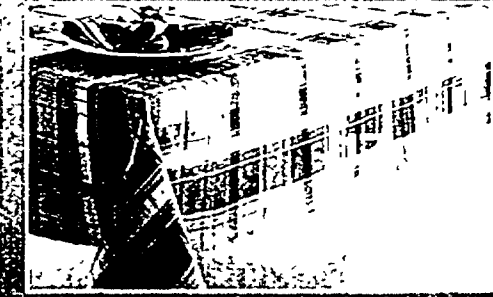

**20.99**  
Sonoma microplush placemat



**40-50% off entire stock**  
area rugs & matching scatter rugs  
selected items online P91336

**99.99**  
Sonoma 5'3"x7'10" area rug. reg. 199.99



**50% off entire stock**  
luggage  
reg. 24.99-379.99, sale 12.49-189.99  
selected items online H1740



**79.99**  
Ricardo® Santa Cruz 21" upright. reg. 159.99



**149.99**  
Samsonite® Dimension 22" upright. reg. 299.99



**save an extra 15%** on everything in store & online every time you use your Kohl's Charge  
Thurs.-Tues., Sept. 14-19, 2006

Kohl's Charge offer is good on all sale-, regular- and clearance-priced merchandise. This offer is good on American Beauty, FLIRTI, good skin, and grassroots™ beauty products. Offer not valid for price adjustments on prior purchases, on Gift Card purchases, for payment on a Kohl's Charge account or in conjunction with any other percent-off discounts, including the Senior Citizen discount. Offer also not valid on purchases of Kohl's Cares for Kids® merchandise or other charitable items. Excludes sales tax. Don't have a Kohl's Charge? Open an account today to take advantage of this offer. Subject to credit approval. See store for details.



# 4 PAGES OF BONUSBUY SAVINGS

Entire Stock  
**50% off**  
Decorative pillows  
Online #9131

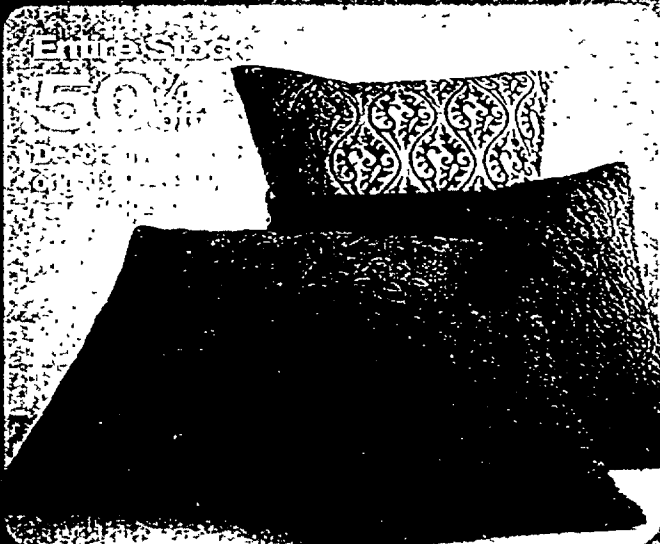

Entire Stock  
**50% off**  
Decorative pillows  
Online #9131



Entire Stock  
**50-60% off**  
Solid bath towels  
Bath rugs  
Choose from  
the Big One  
by Dr. Ashley  
with 100% cotton  
towel sets  
Online #9131

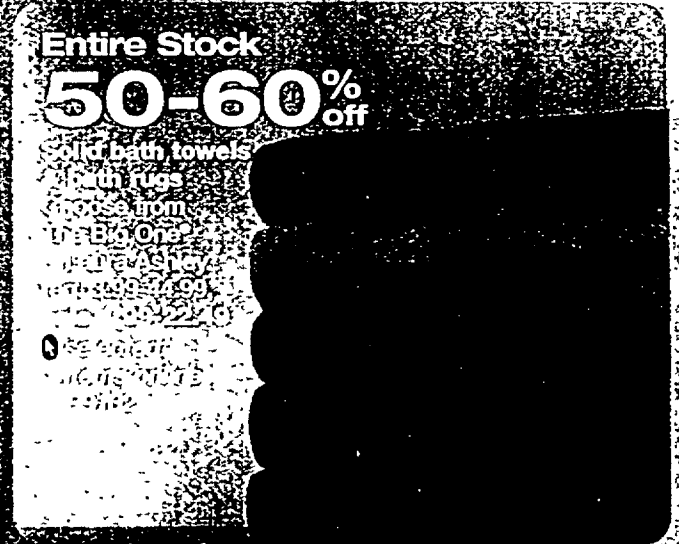

# BONUSBUY SAVINGS

## FOR YOUR HOME Thursday-Tuesday, September 14-19

Entire Stock  
**15-50% off**  
Kitchen electrics

**9.99**  
After \$10  
mail-in  
rebate  
Cuisinart  
10-cup  
classic  
coffeemaker  
reg. 39.99  
sale 19.99

**199.99**  
KitchenAid® Classic Plus  
Stand Mixer, reg. 279.99

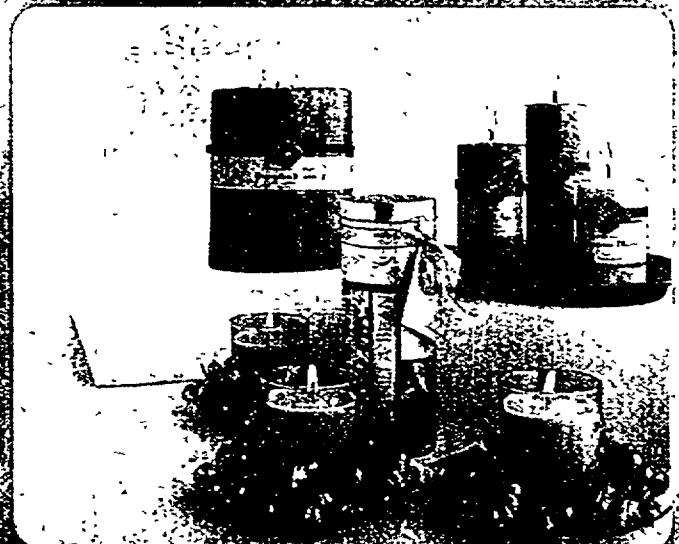

Entire Stock  
**50-60% off**  
Selected items of line #9131

save an extra **15%** on everything  
in store & online every time you use your Kohl's Charge  
Thursday-Tuesday, Sept. 14-19, 2006 Subject to credit approval; see page 29 for details.



Prices good Thursday, September 14-Saturday, September 23, 2006.  
Store Hours: Thursday-Saturday, September 14-16 8am-11pm; Sunday, September 17 10am-9pm; Monday-Friday, September 18-22 8am-10pm; Saturday, September 23 7am-10pm Oxnmoor, KY store open Sunday Noon-9pm.

**\$5 shipping**  
\$5 standard shipping on your entire order at Kohl's.com now-Sept. 23, 2006. Surcharges may apply due to size, weight or special handling.

For the Kohl's Store nearest you call 1-800-837-1500 or visit us on the Web at Kohls.com

Selection may vary by store. Some merchandise may not be available at every store. "Sale" prices and percentage savings offered in this advertisement are discounts from Kohl's "Regular" or "Original" prices. The "Regular" or "Original" price of an item is the former or future offered price for the item or a comparable item by Kohl's or another retailer. Actual sales may not have been made at the "Regular" or "Original" prices, and intermediate markdowns may have been taken. Clearance merchandise is excluded from "Entire Stock" promotions in this advertisement. In some events, actual savings may exceed the percent savings shown. KOHL'S® and KOHL'S brand names are trademarks of Kohl's Illinois, Inc. ©2006 Kohl's Department Stores, Inc.

DISCOVER THE LATEST INNOVATIONS

THE WORLD'S LARGEST HOME SHOW

THE  
HOME  
DEPT.

# HOME SHOW 06

100s OF  
INNOVATIONS

NEVER PAINT  
OR STAIN  
YOUR FENCE AGAIN

SELF-CLEANING  
WINDOWS  
THAT SAVE ENERGY

THE WORLD'S  
MOST VERSATILE  
BLESS  
SYSTEM



# HOME SHOW TAG

## WHAT'S NEW FOR OUR WE'RE G

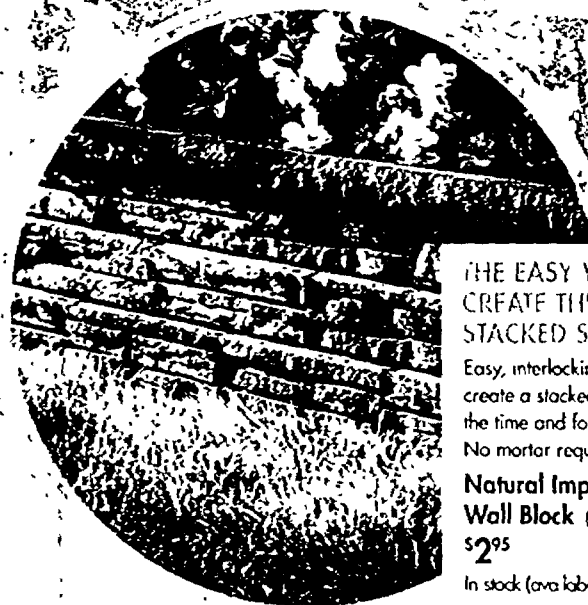

### THE EASY WAY TO CREATE THE LOOK OF STACKED STONE

Easy, interlocking installation allows you to create a stacked stone look in a fraction of the time and for a fraction of the cost!  
No mortar required

#### Natural Impressions®

Wall Block (280466)

\$2.95

In stock (availability varies by market)

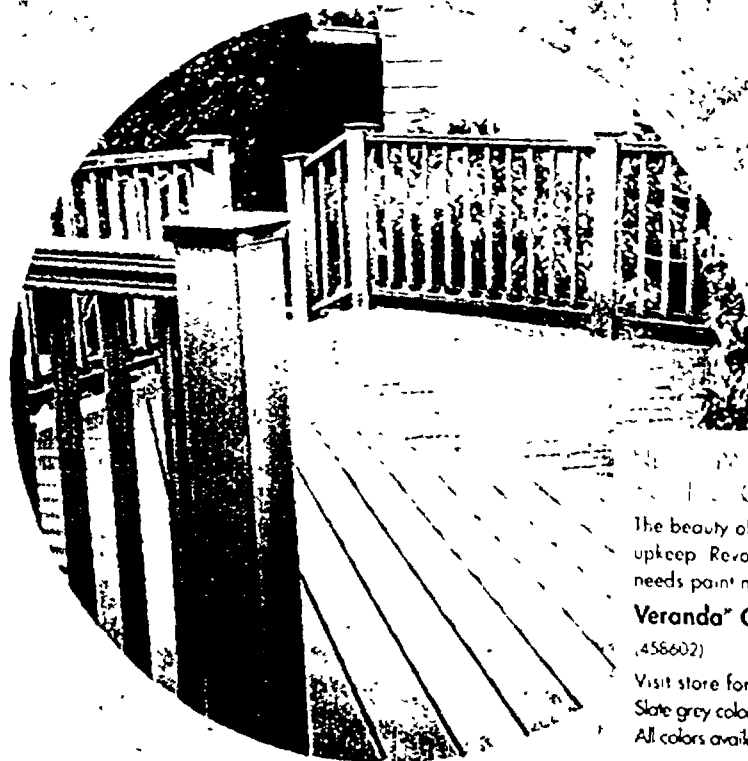

### NEW! THE LOOK OF WOOD WITHOUT THE MAINTENANCE

The beauty of wood without the upkeep. Revolutionary material never needs painting or staining.

#### Veranda® Composite Decking

(458602)

Visit store for prices

Slate grey color in stock most locations

All colors available in store by Special Order



DISCOVER THE LATEST INNOVATIONS

# HOME SHOW

THE WORLD'S LARGEST HOME SHOW



You can do it. We can help.

3 FOR \$10  
1-GALLON  
ASSORTED  
LANDSCAPE  
SHRUBS  
(244068)



\$14<sup>96</sup> WAS \$24<sup>96</sup>  
5-GALLON ASSORTED  
LANDSCAPE SHRUBS  
Choose from Colorado  
Spruce, Lilac, Burning  
Bush and Arbs (783498)

\$3<sup>99</sup> WAS \$4<sup>99</sup>  
VIGORO<sup>®</sup> MULCH  
WITH WEED STOP  
2 CU. FT (624189)



See page 18 for details

\$26<sup>59</sup> WAS \$37<sup>99</sup>  
HAMPTON BAY<sup>™</sup> MOTION  
SENSOR WALL LANTERN  
Also available in white.  
(248617)(248593)

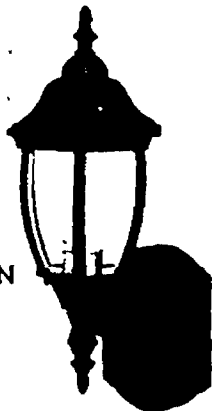

**10% OFF TREX<sup>®</sup> + \$50 GIFT CARD<sup>†</sup>**  
**DECKING & RAILING**  
FROM THE HOME DEPOT FOR EVERY \$500  
SPENT ON TREX<sup>®</sup> DECKING PRODUCTS



Trex decking is available through special order. May be stocked in select stores; see store for details.

**NEVER PAINT OR STAIN YOUR DECK AGAIN.**  
Trex Decking is made from recycled and reclaimed wood and plastic. Resists rot, cracks and splinters. (333270)



\$299<sup>99</sup> WAS \$399<sup>99</sup>  
6' 15-LITE STEEL FRENCH DOOR  
Model # 222338 (1) (222338)



SPECIAL BUY  
\$369 WAS \$399  
CHARMGLOW<sup>®</sup> GAS GRILL  
40,000 BTU with side burner

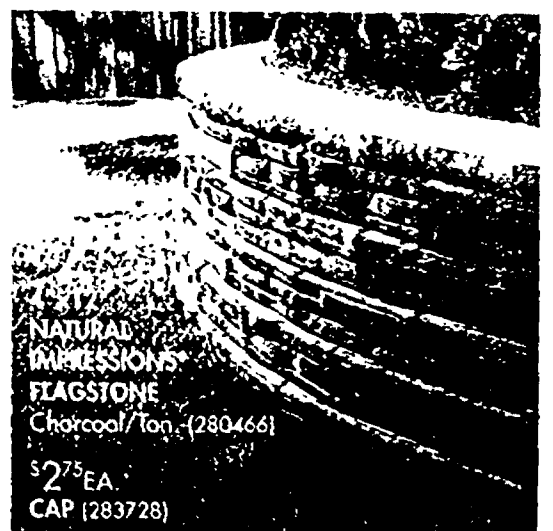

NATURAL IMPRESSIONS  
FLAGSTONE  
Charcoal/Ton. (280466)  
\$2<sup>75</sup> EA.  
CAP (283728)

10% off valid 9/14 - 9/30. Receive 10% (price shown reflects 10% savings) off in-stock and special order Trex Decking & Railing products (SKU 333270 and 346651) and receive a \$50 The Home Depot gift card by mail in rebate for every \$500 spent on Trex decking products. Qualifying total is based on pre-tax price. Offer valid on single receipt purchase. Offer valid on purchases made at participating U.S. The Home Depot stores (excludes AK and HI). Limit of two (2) \$50 gift cards per household. See rebate form for complete details.





# TAKE THE GUESSWORK OUT OF WATERING.



SOIL THAT PROTECTS AGAINST OVER & UNDER-WATERING

Formulated with AquaCoir® natural fiber technology to absorb excess water and release it to the plant as needed

MIRACLE GRO MOISTURE CONTROL 64 QT. Potting soil enriched with Miracle-Gro Plant Food

(625604) **\$12.47**

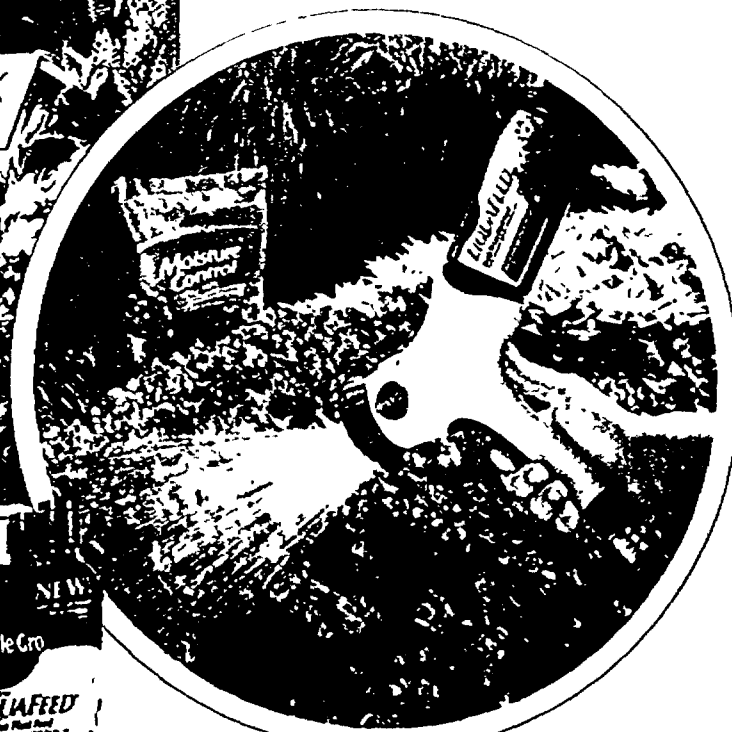

NEW SYSTEM MAKES FEEDING PLANTS EASIER THAN EVER

No mixing, no measuring and no mess! Patented feeder and ready to use system allows you to connect to the hose and go



**\$14.99**

MIRACLE-GRO® LIQUAFEED STARTER KIT (625793)

LIQUAFEED REFILL 4-PACK (623603) **\$9.99**

## LANDSCAPE BOOSTERS

Fertilizers and accessories to help you grow a healthy lawn



STANDARD BROADCAST SPREADER

(536365) **\$26.99**

DELUXE BROADCAST SPREADER

(572324) **\$39.88**



**\$10.88**

WINTERGUARD® LAWN FERTILIZER 5,000 SQ. FT. (896586)

15,000 SQ. FT. (548448) **\$27.88**



**\$13.88**

WINTERGUARD® WITH PLUS 2" WEED CONTROL 5,000 SQ. FT. (971307)

15,000 SQ. FT. (246725) **\$36.88**

## TACKLE YOUR YARD WITH WINTERGUARD

\$3 OFF ANY 5,000 SQ. FT. BAG OR \$7 OFF ANY 15,000 SQ. FT. BAG, BY MANUFACTURER'S MAIL-IN REBATE WHEN YOU PURCHASE SCOTT'S TURF BUILDER® WINTERGUARD® PRODUCTS.\*\*

100-195-201-219-441-300-110-284-4

# LATEST HYBRID VARIETIES & ORGANIC SOILS.

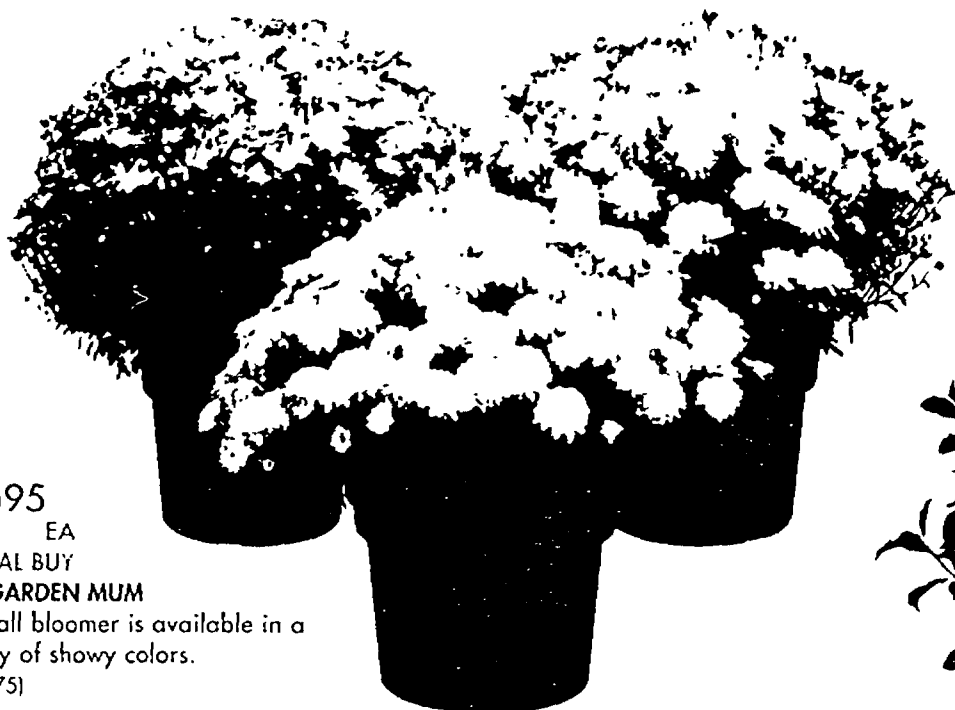

**\$9.95** EA  
**SPECIAL BUY**  
**10" GARDEN MUM**  
 This fall bloomer is available in a variety of showy colors.  
 (601375)

**3 FOR \$10**

**YOUR CHOICE**  
**GALLON ASSORTED SHRUBS**  
 Choose from Alberta Spruce, Butterfly Bush, Arborvitae, Weigela and Boxwood (244068)

**HOMESHOW** (814)

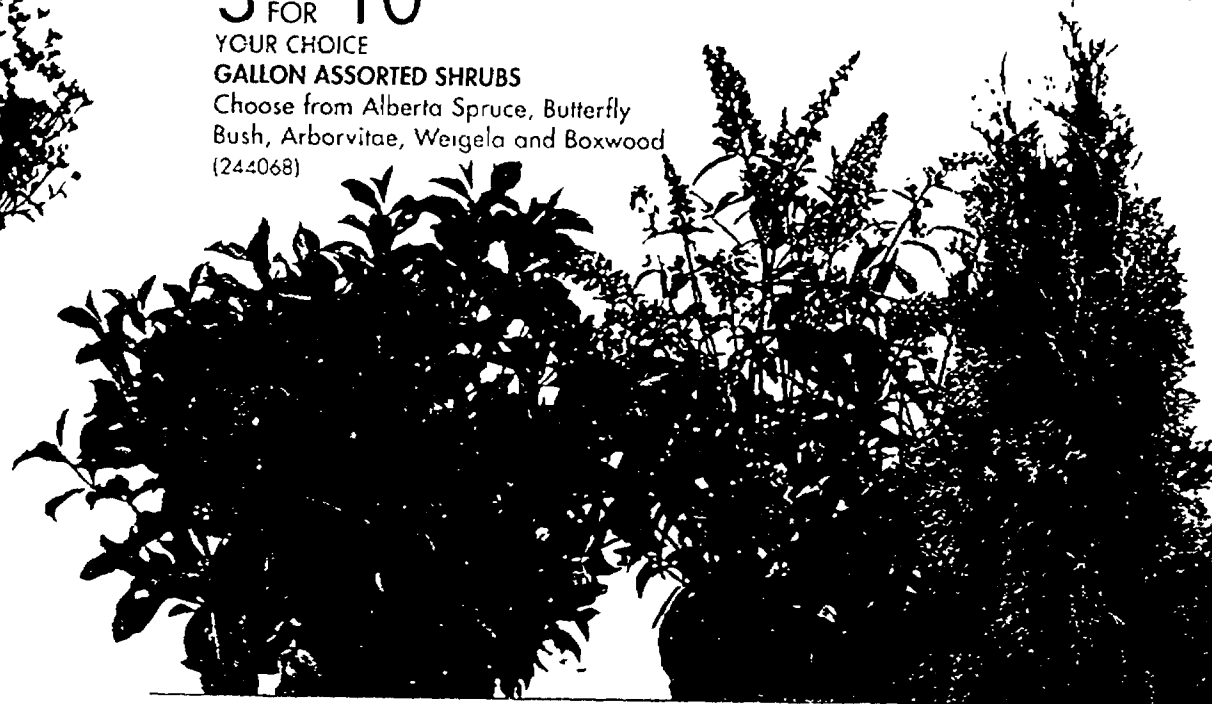

**FALL IS THE BEST TIME TO PLANT**



**3-GALLON TREE PROMO**  
 (488191) **\$12.96**



**ASSORTED BULBS** (235848)(235850)  
 (235851)(235853) **\$7.96**



**2 GALLON ASSORTED PERENNIALS**  
 (474337) **\$9.96**



**2-GALLON FALL LANDSCAPE SHRUB**  
 (290661) **\$9.96**

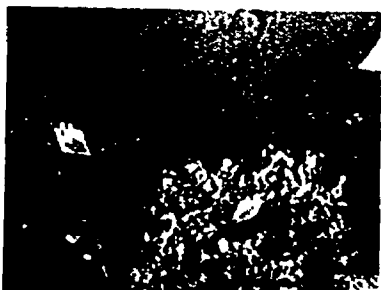

**8" ANGEL HANGING BASKET**  
 (112010) **\$12.99**



**10" HOUSE PLANT**  
 (673872) **\$9.99**

**BUY 2 GET 1 FREE!**

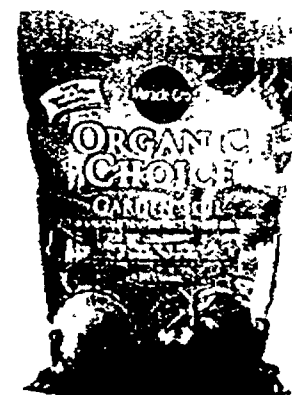

**\$3.99**  
**1 CU. FT. MIRACLE-GRO®**  
**ORGANIC CHOICE GARDEN SOIL**  
 (433986)

Offer valid 9/14/06-9/20/06. Discount taken at register. See store for details.



## CERTIFIED NURSERY CONSULTANTS

YOU CAN COUNT ON THE HOME DEPOT TO PROVIDE EXPERT ADVICE FROM OUR CERTIFIED NURSERY CONSULTANTS. FOR ALL OF YOUR GARDENING QUESTIONS, TRUST THE EXPERTS. ASK A CERTIFIED NURSERY CONSULTANT TODAY.

SEE MORE INNOVATIONS ONLINE @ [HOMEDEPOT.COM/HOMESHOW](http://HOMEDEPOT.COM/HOMESHOW)



# THE LOOK OF WOOD WITHOUT THE UPKEEP.

**\$2489**

SPECIAL ORDER  
36" SILVERDALE CRAFTSMAN  
PREFINISHED MEDIUM OAK  
WOODGRAIN ENTRY DOOR  
WITH 2 SIDELITES  
Triple pane insulated glass  
Features zinc caming



*Feather River Door Company*

FIBERGLASS ENTRY  
SYSTEMS WITH A  
WOODGRAIN FINISH

Weather-resistant, low-maintenance and insulating fiberglass doors, fused with the look of stained real wood and texture.

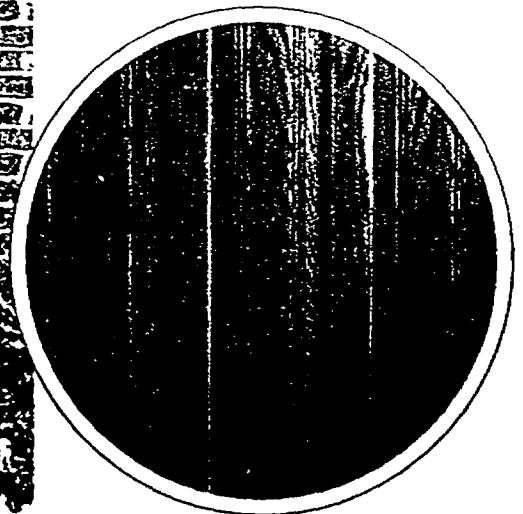

**\$449**

IN STOCK  
SINGLE DOOR  
(610669)(610674)



**\$1677**

SPECIAL ORDER  
SINGLE DOOR  
WITH 1 SIDELITE



**\$1730**

SPECIAL ORDER  
DOUBLE DOOR



**\$1354**

SPECIAL ORDER  
36" SILVERDALE  
FULL LITE PREFINISHED  
MEDIUM OAK WOOD-  
GRAIN WITH ZINC CAM-  
ING

**\$2978**  
SINGLE DOOR  
WITH 2  
SIDELITES

**\$2708**  
DOUBLE DOOR



**\$837**

SPECIAL ORDER  
36" LAKEWOOD  
3/4 LITE PREFINISHED  
LIGHT OAK WOOD-  
GRAIN WITH ZINC  
CAMING

**\$2148**  
SINGLE DOOR  
WITH 2  
SIDELITES

**\$1673**  
DOUBLE DOOR



**\$690**

SPECIAL ORDER  
36" MEDINA CENTER  
ARCH PREFINISHED  
MEDIUM OAK WOOD-  
GRAIN WITH BRASS  
CAMING

**\$1747**  
SINGLE DOOR  
WITH 2  
SIDELITES

**\$1380**  
DOUBLE DOOR



**\$586**

SPECIAL ORDER  
36" PRESTON  
HALF LITE SMOOTH  
PAINTABLE FINISH  
WITH PATINA CAM-  
ING

**\$1363**  
SINGLE DOOR  
WITH 2  
SIDELITES

**\$1171**  
DOUBLE DOOR

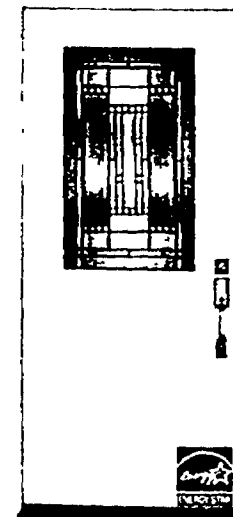

**12** NO PAYMENTS  
NO INTEREST FOR  
MONTHS\*

ON ANY WINDOW, DOOR OR  
MOULDING PURCHASE OF \$299 OR  
MORE MADE ON THE HOME DEPOT  
CONSUMER CREDIT CARD



DOORS INSTALLED FOR YOU  
START TODAY VISIT YOUR LOCAL STORE.  
OUR NETWORK OF LICENSED PROFESSIONALS WILL INSTALL  
YOUR NEW DOORS, AND WE'LL GUARANTEE ALL WORK.\*

101 106 109 127 131 139 143 156 158 164 185 206 207 208 234 235 237 247 262 276 298 300 304 314 322

# OUR MOST CONVENIENT STORM DOOR EVER

## EASY ONE-HAND OPERATION

A simple lock design lets the glass glide up and down smoothly to create multiple ventilation positions with little effort

**\$259**

**36" 3000 TRUEASE™ STORM DOOR**  
White finish. (353472)

- Easy-tilt glass make cleaning a breeze  
No need to remove glass for cleaning
- Unlimited glass placement allows you to improve ventilation and welcome a refreshing breeze

**Andersen**   
Come home to Andersen.™



HOME SHOW 

SPECIAL BUY  
**\$179** was \$199  
**36" 3000 FULLVIEW STORM DOOR**  
White. Full length view for beauty and light Solid brass hardware. (205124)

**Andersen**   
Come home to Andersen.



**\$249**  
**36" 4000 FULLVIEW STORM DOOR**  
White. Full-length view for beauty and light. Glass and insect screen snaps in/out. Solid nickel hardware. (597038)

**Andersen**   
Come home to Andersen.



**\$239**  
**36" 3000 FULLVIEW STORM DOOR WITH ETCHED GLASS**  
Green. 1-1/2" thick aluminum frame. Solid brass hardware. (818104)

**Andersen**   
Come home to Andersen.



**\$184**  
**36" 300 TRIPLE-TRACK STORM DOOR**  
White. Spring-loaded system ventilates from top, bottom or both. Solid brass handle hardware. (818439)

**EMCO.**



SPECIAL BUY  
**\$179** was \$219  
**36" 2000 SELF-STORING STORM DOOR**  
White. Exclusive SlideAway insect screen retracts into door frame and remains out of sight when not in use (134492)

**Andersen**   
Come home to Andersen.

**\$59 BASIC INSTALLATION ON ANDERSEN BRANDED STORM DOORS.**

BY MAIL-IN REBATE FROM 8/31/06 - 9/20/06\*\*

\*\* Valid at participating US The Home Depot stores. Not valid on EMCO or Forever brand storm doors. Not valid on prior purchases or clearance merchandise. Cannot be combined with any other offer except consumer credit offers. No credit if offer refused. Ask an associate for rebate form with complete rebate details.

SEE MORE INNOVATIONS ONLINE @ [HOMEDEPOT.COM/HOMESHOW](http://HOMEDEPOT.COM/HOMESHOW) 7

# SELF-CLEANING GLASS THAT SAVES ENERGY.

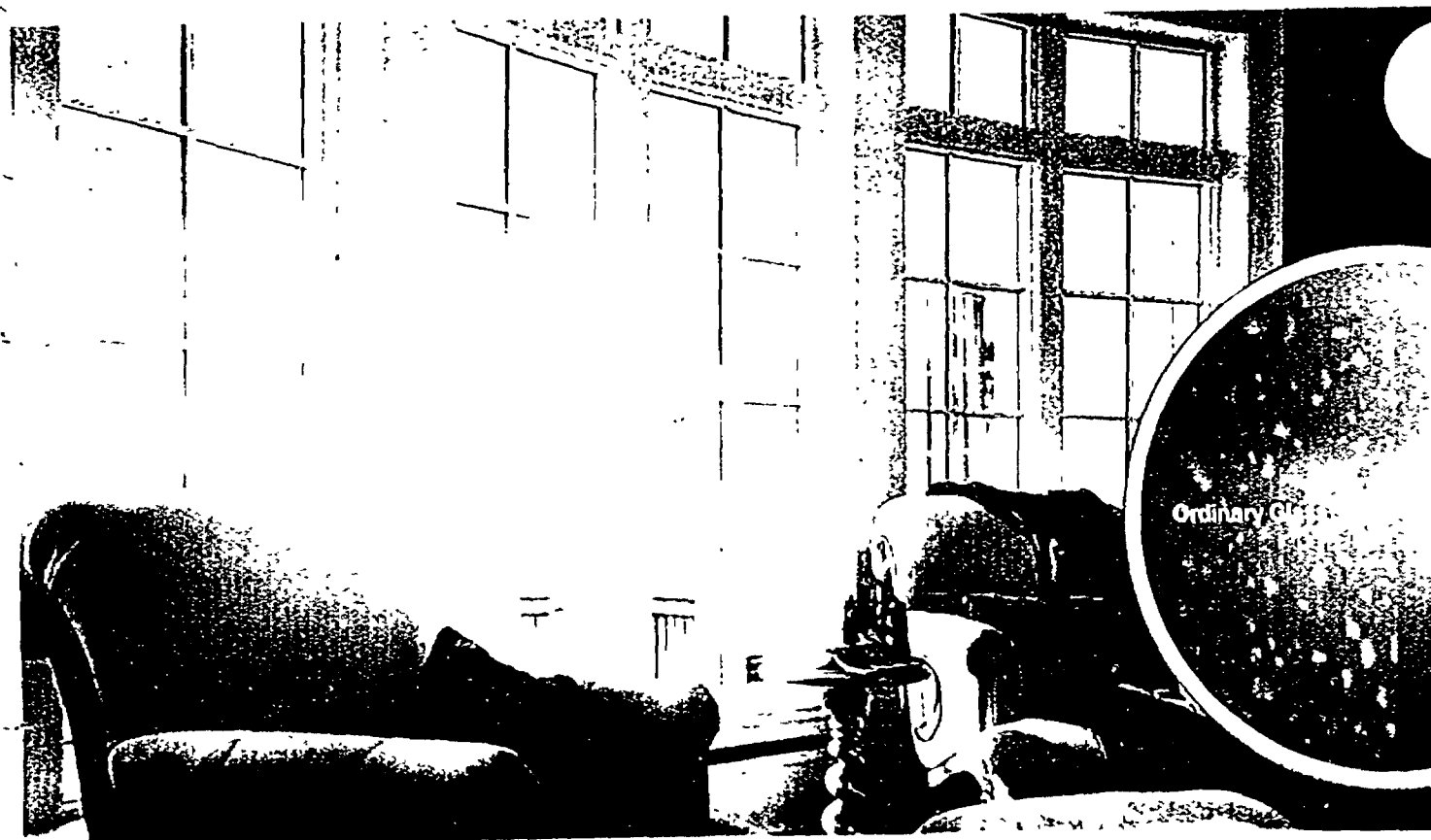

LOW-E4 GLASS IS MORE EFFICIENT & EASIER TO CLEAN

A titanium dioxide coating activated by sunlight, helps the High-Performance<sup>®</sup> glass stay cleaner longer by reducing water spots, and filtering UV rays to lower your energy costs

*\*\*Up to 99% Exterior glass only when activated by sunlight*

WINDOVS-DOORS  
**Andersen**  
Come home to Andersen.

Now available through special order on Andersen 400 Series products

## TRUSCENE<sup>™</sup> INSECT SCREEN

Nearly invisible with over 50% more clarity than standard screens. Now available with 400 series windows

- Protection against even the smallest insects
- Lets more sunlight into your home
- Provides superior ventilation
- The strength of stainless steel

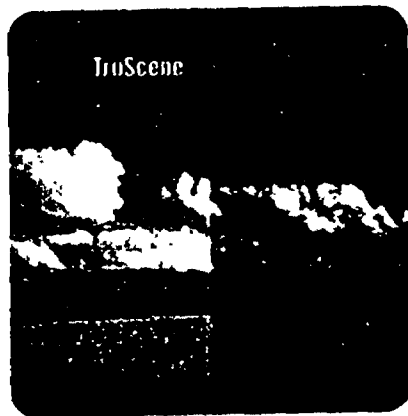

## DIVIDED LIGHT

Choose from standard patterns to custom designs, removable and permanent grilles and more

- Standard patterns available in 8 popular styles
- Equal light patterns for a more customized look
- Custom Patterns to create your own design

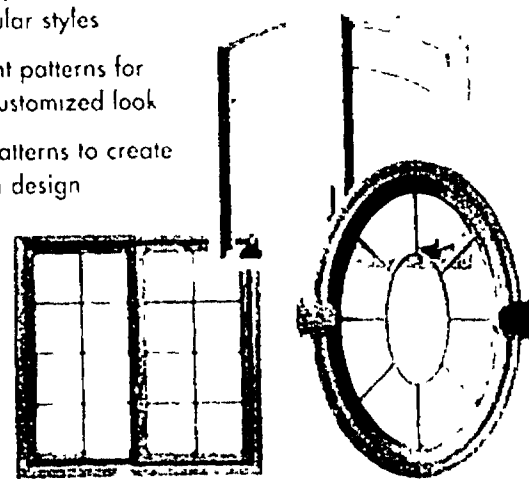

## ADD BEAUTIFUL ACCENTS

Create a transparent look while maintaining privacy, express your individuality, or add a touch of elegance

- Frank Lloyd Wright Series - inspired by simplicity & nature
- Artisan Series - organic lines with asymmetrical shapes
- Classic Series - 5 major architectural design themes

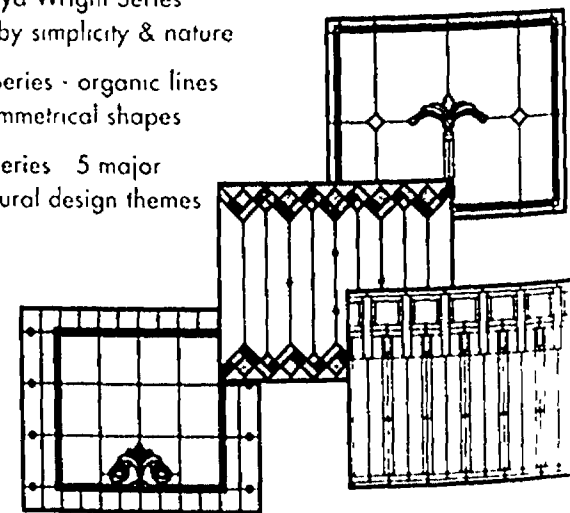

# 12 MONTHS<sup>\*</sup> NO PAYMENTS, NO INTEREST

ON ANY WINDOW, DOOR OR MOULDING PURCHASE OF \$299 OR MORE MADE ON THE HOME DEPOT CONSUMER CREDIT CARD FROM 9/7/06 - 9/17/06.

\*When purchased with The Home Depot Consumer Credit Card. Additional terms apply. See page 23 for key credit.

24 181 13 390 45 50 1 7 60 89 97 192 115 138 173 176 177 178 246 282 290 303 310 327 330 335 338 392 403 405 447 448 10 15 15U 20 20U 39 39U 65 66 68 86 93 111 112 116 191 260 272 42  
 26 29 31 33 35 37 39 41 43 45 47 49 51 53 55 57 59 61 63 65 67 69 71 73 75 77 79 81 83 85 87 89 91 93 95 97 99 101 103 105 107 109 111 113 115 117 119 121 123 125 127 129 131 133 135 137 139 141 143 145 147 149 151 153 155 157 159 161 163 165 167 169 171 173 175 177 179 181 183 185 187 189 191 193 195 197 199 201 203 205 207 209 211 213 215 217 219 221 223 225 227 229 231 233 235 237 239 241 243 245 247 249 251 253 255 257 259 261 263 265 267 269 271 273 275 277 279 281 283 285 287 289 291 293 295 297 299 301 303 305 307 309 311 313 315 317 319 321 323 325 327 329 331 333 335 337 339 341 343 345 347 349 351 353 355 357 359 361 363 365 367 369 371 373 375 377 379 381 383 385 387 389 391 393 395 397 399 401 403 405 407 409 411 413 415 417 419 421 423 425 427 429 431 433 435 437 439 441 443 445 447 449 451 453 455 457 459 461 463 465 467 469 471 473 475 477 479 481 483 485 487 489 491 493 495 497 499 501 503 505 507 509 511 513 515 517 519 521 523 525 527 529 531 533 535 537 539 541 543 545 547 549 551 553 555 557 559 561 563 565 567 569 571 573 575 577 579 581 583 585 587 589 591 593 595 597 599 601 603 605 607 609 611 613 615 617 619 621 623 625 627 629 631 633 635 637 639 641 643 645 647 649 651 653 655 657 659 661 663 665 667 669 671 673 675 677 679 681 683 685 687 689 691 693 695 697 699 701 703 705 707 709 711 713 715 717 719 721 723 725 727 729 731 733 735 737 739 741 743 745 747 749 751 753 755 757 759 761 763 765 767 769 771 773 775 777 779 781 783 785 787 789 791 793 795 797 799 801 803 805 807 809 811 813 815 817 819 821 823 825 827 829 831 833 835 837 839 841 843 845 847 849 851 853 855 857 859 861 863 865 867 869 871 873 875 877 879 881 883 885 887 889 891 893 895 897 899 901 903 905 907 909 911 913 915 917 919 921 923 925 927 929 931 933 935 937 939 941 943 945 947 949 951 953 955 957 959 961 963 965 967 969 971 973 975 977 979 981 983 985 987 989 991 993 995 997 999

# ANDERSEN® – YOUR BRAND FOR SELECTION.

HOME SHOW 06



STARTING AT \$227

SPECIAL ORDER

**400 SERIES WOODWRIGHT REPLACEMENT WINDOW**

If your old windows are drafty or damaged you can replace them while maintaining the look of your home 16-1/2" x 32" (606439)

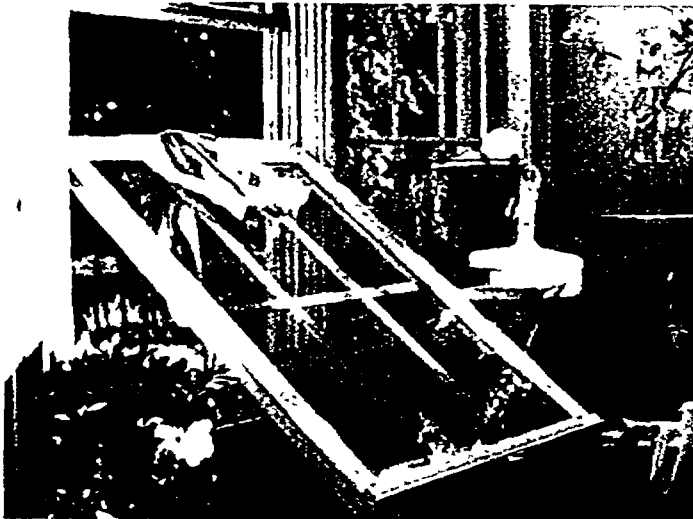

STARTING AT \$211

IN STOCK

**SERIES 400 TILT-WASH DOUBLE-HUNG WINDOW**

Virtually maintenance-free exteriors. Tilt-to-clean design makes cleaning easy. Natural wood interiors. Both sash operate for maximum ventilation. 2432 (470692)



STARTING AT \$136

SPECIAL ORDER

**400 SERIES CASEMENT WINDOW**

High-Performance Low E glass for energy efficiency. Virtually maintenance-free white exteriors. Natural pine interiors. CR12



STARTING AT \$133

IN-STOCK

**SERIES 200 DOUBLE-HUNG PRE-FINISHED INTERIOR WINDOW LOW-E GLASS**

Tilt feature allows wash access to either side. Clear pine. Grilles and screens sold separately. White 2030. (237295)

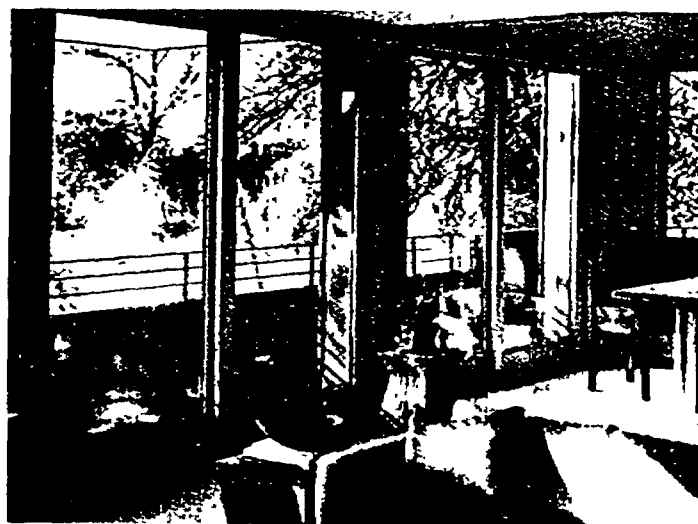

STARTING AT \$949

SPECIAL ORDER

**400 SERIES FRENCHWOOD® GLIDING PATIO DOOR**

Classic French styling with superior design, it glides smoothly and easily on precision ball bearing rollers. 6068. (606439)



\$599

IN-STOCK

**6' SERIES 200 PERMA-SHIELD® REPLACEMENT GLIDING PATIO DOOR**

20-year warranty on glass only, 10-year limited warranty on non-glass parts. Features Low-E glass. Grilles, screen and hardware sold separately. (616240) (616241)

Andersen.   
Come home to Andersen.®



## CUT UTILITY COSTS – NOT PERFORMANCE

NEW WINDOWS LOOK GREAT AND CAN HELP YOU SAVE MONEY ON YOUR ENERGY BILLS. NEW WINDOWS GENERALLY SEAL BETTER AND INSULATE BETTER, WHICH CUTS DOWN ON THE ENERGY YOU NEED TO HEAT OR COOL YOUR HOME; SAVING MONEY AND THE ENVIRONMENT

SEE MORE INNOVATIONS ONLINE @ [HOMEDEPOT.COM/HOMESHOW](http://HOMEDEPOT.COM/HOMESHOW) 9

# NEVER PAINT OR STAIN YOUR FENCE AGAIN.

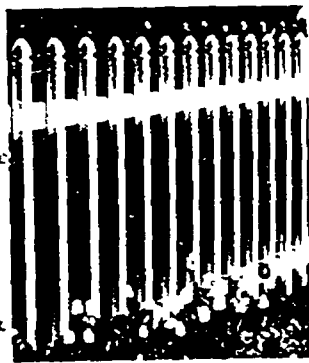

**VERANDA**  
36 1/2"x92 1/4"  
CLASSIC PICKET  
VINYL FENCE  
PANEL (199589)  
\$39<sup>97</sup> ea.



**VERANDA**  
SPECIAL ORDER  
68-3/8"x68"  
WINDHAM  
WICKER  
VINYL FENCE  
PANEL  
\$79<sup>97</sup> ea.



**CON**  
SPECIAL ORDER  
69"x66.725"  
CEDAR FINISH  
PRIVACY PANEL  
\$99<sup>97</sup> ea.

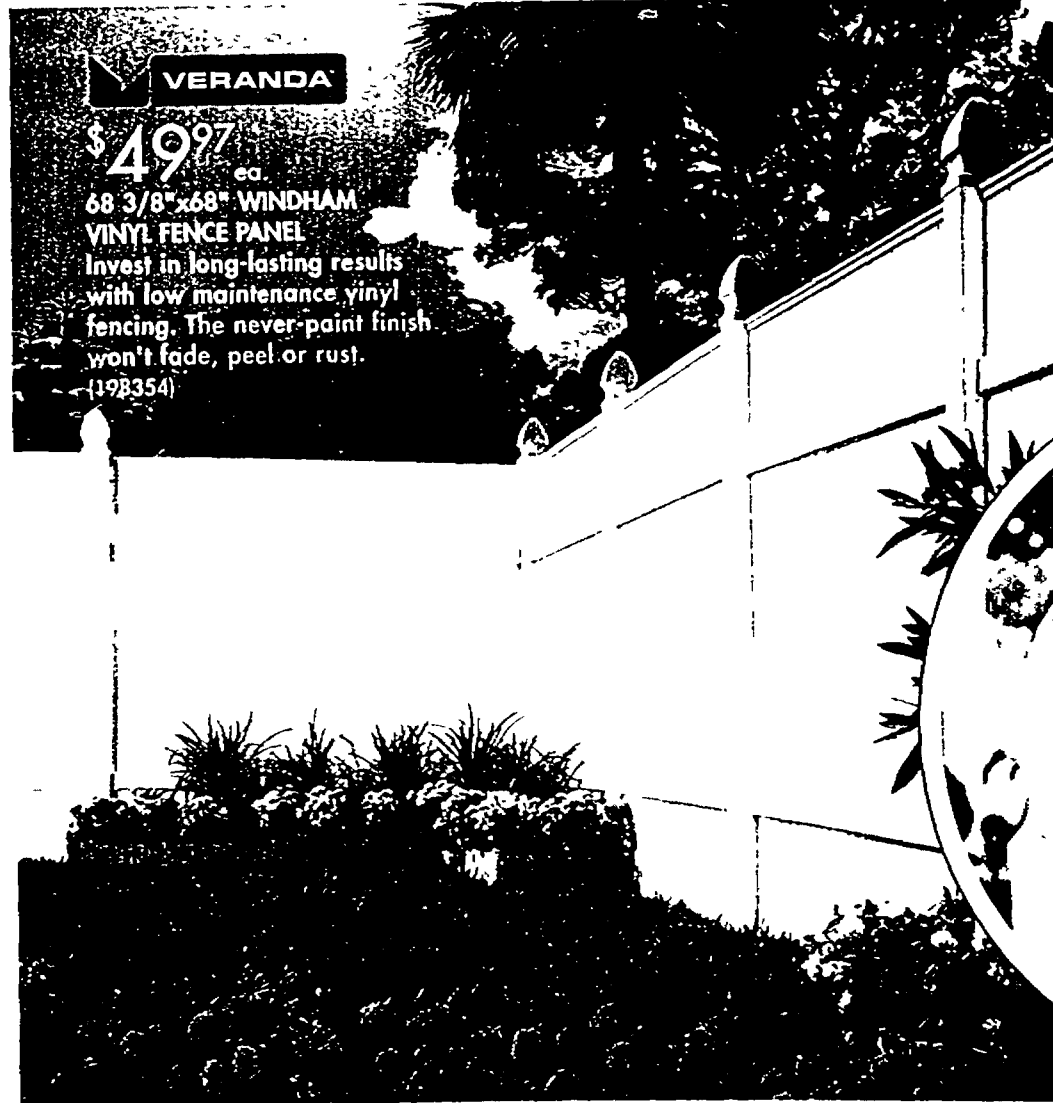

**VERANDA**  
\$49<sup>97</sup> ea.  
68 3/8"x68" WINDHAM  
VINYL FENCE PANEL  
Invest in long-lasting results  
with low maintenance vinyl  
fencing. The never-paint finish  
won't fade, peel or rust.  
(198354)

LOW-  
MAINTENANCE  
FENCING THAT'S  
BUILT TO LAST

Made of vinyl, all Veranda products will never rot, warp, dent, blister or decay. Designed to resist damage from sun, wind, water and insects



## VERANDA TUF BOARD

A pvc vinyl composite board that is a perfect replacement for wood in most non-stress-bearing applications. It looks, feels, cuts, nails and fastens just like wood. TUF board's moisture and insect resistant properties make it a great material for outdoor projects.

**VERANDA**

### PVC TUF BOARDS

SIZE	8'	12'
3/4"x1 1/2"	\$3 <sup>98</sup>	—
3/4"x3 1/2"	\$8 <sup>59</sup>	\$12 <sup>88</sup>
3/4"x5 1/2"	\$12 <sup>86</sup>	—
3/4"x7 1/4"	\$17 <sup>29</sup>	\$25 <sup>77</sup>



## FENCING INSTALLED FOR YOU

**START TODAY: CALL 1-800-HOMEDEPOT**  
OUR NETWORK OF LICENSED PROFESSIONALS WILL TAKE CARE OF ALL THE DETAILS SO YOU DON'T HAVE TO AND WE'LL GUARANTEE ALL WORK.\*

Post and post tops are sold separately. Panels vary by store. Check location for special order or in-stock availability. Pricing stated is for panels and pickets. Professional installation is available for an additional charge. See page 23 for license numbers (where applicable). See contract for guarantee details.

# A LADDER FOR EVERY PROJECT.

HOME SHOW **06**



## 13 LADDERS ALL-IN-ONE

Just one compact and light-weight ladder converts into 13 adjustable positions. This multi-purpose tool transforms to twin-stepladder, extension ladder, stairway ladder, and scaffold base.

### GREAT VALUE

as recognized by a leading independent consumer publication.\*\*

\$99

**CRILLA LADDERS**

## 13' Aluminum Multi-Position Ladder

Adjust height in seconds with locking tabs. Includes patented static hinges for safer and quicker scaffold base use. 300 lb. capacity. (135730)

\$198

**21' ALUMINUM MULTI-POSITION**  
28 adjustable positions.  
300 lb. capacity. (670750)

**Louisville**

\$79 SPECIAL BUY

**16' ALUMINUM EXTENSION**  
Ideal for painting and light maintenance. Light enough to be carried by one person. 225 lb. capacity. (276411)

\$142

**24' LADDER**  
225 lb. capacity. (604129)

**Louisville**

\$159

**16' FIBERGLASS EXTENSION**  
Non-conductive fiberglass, natural choice for electrical work. 250 lb. capacity (636244)

\$199

**24' LADDER**  
300 lb. capacity (605443)

**HUSKY.**

SPECIAL BUY

\$29<sup>99</sup>

**5' FIBERGLASS**

Unique size great for all projects. Non-conductive, safe for electrical projects. 200 lb. capacity. (144286)

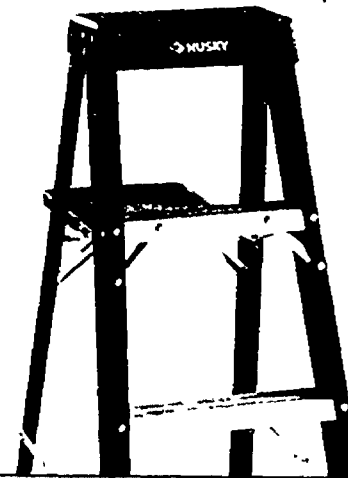

**HOME**

SPECIAL BUY

\$29<sup>99</sup>

**2 STEP WOODEN STOOL**

Attractive dark cherry finish. Handcrafted wood complements home decor. 200 lb. capacity. (606900)

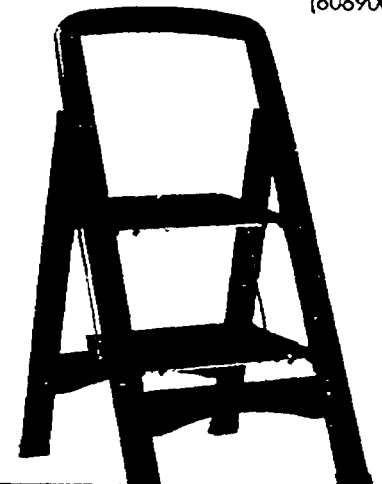

**HUSKY.**

\$35<sup>99</sup>

**EASY CLICK STABILIZER**

Attaches and removes 10 times faster than standard stabilizer. Convenient paint bucket hook and protective end caps included. (200828)

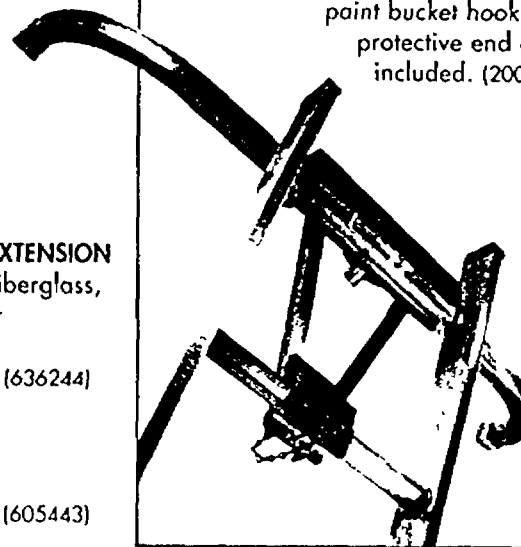

**HUSKY.**

\$99

**LADDER RACK FOR TRUCKS**

Flat and angled positions for convenient loading. Adjustable load bar between 26" and 36". 250 lb. load capacity. (213538)

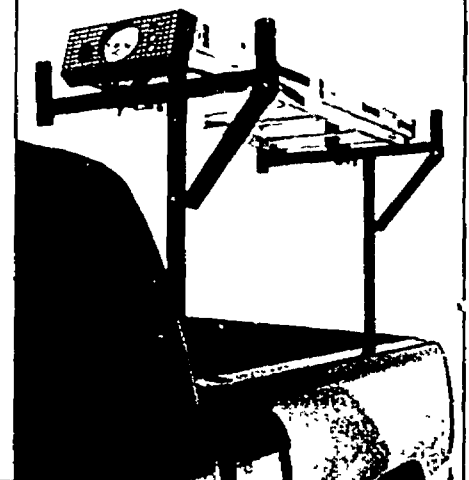

VISIT THE VIRTUAL HOME  
[HOMEDPOT.COM/HOMESHOW](http://HOMEDPOT.COM/HOMESHOW)

EXPERIENCE THE HOME SHOW ONLINE

TAKE A VIRTUAL STROLL THROUGH OUR NEW ONLINE VIRTUAL HOME. YOU'LL FIND DOZENS OF THE LATEST INNOVATIONS FOR EVERY ROOM IN THE HOUSE. EXPLORE INTERACTIVE DEMOS, BROWSE, BUY AND MORE - ALL WITH THE CLICK OF A MOUSE.

SEE MORE INNOVATIONS ONLINE @ [HOMEDPOT.COM/HOMESHOW](http://HOMEDPOT.COM/HOMESHOW) 11

1,2,3,4,9,14,18,19,23,25,26,27,28,30,34,34U,43,43U,45,50,57,60,89,97,102,115,138,173,176,177,178,246,282,290,303,310,327,330,335,338,392,403,405,447,448,10,15,15U,20,20U,39,39U,65,66,68,86,93,111,112,116,191,260,272,42,3,6,6U,12,21,21U,29,36,47,48,48U,63,87,134,196,226,72,106,109,139,156,157,237,322,323,332,342,366,371,445,451,452,453,5,8,13,16,17,40,42,58,73,113,122,129,147,148,152,160,163,167,171,175,211,212,230,231,233,249,302,307,308,312,329,331,347,348,349,355,367,367,421,424,433,443,444,51,54,76,77,94,190,195,204,213,244,306,316,324,400. PG 0811. BASE @ PRICE 1

\*\*No endorsement/affiliation is intended or implied

# NEW WAYS TO COMPLETE YOUR TASKS QUICKLY.

BLACK & DECKER

\$19<sup>97</sup>  
NEW  
114-PIECE  
SCREWDRIVING  
SET (106526)

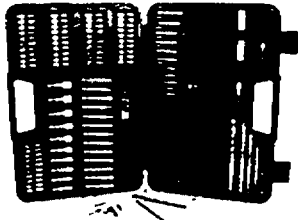

BLACK & DECKER

\$9<sup>97</sup>  
45-PIECE  
SCREWDRIVER  
BIT SET (197674)

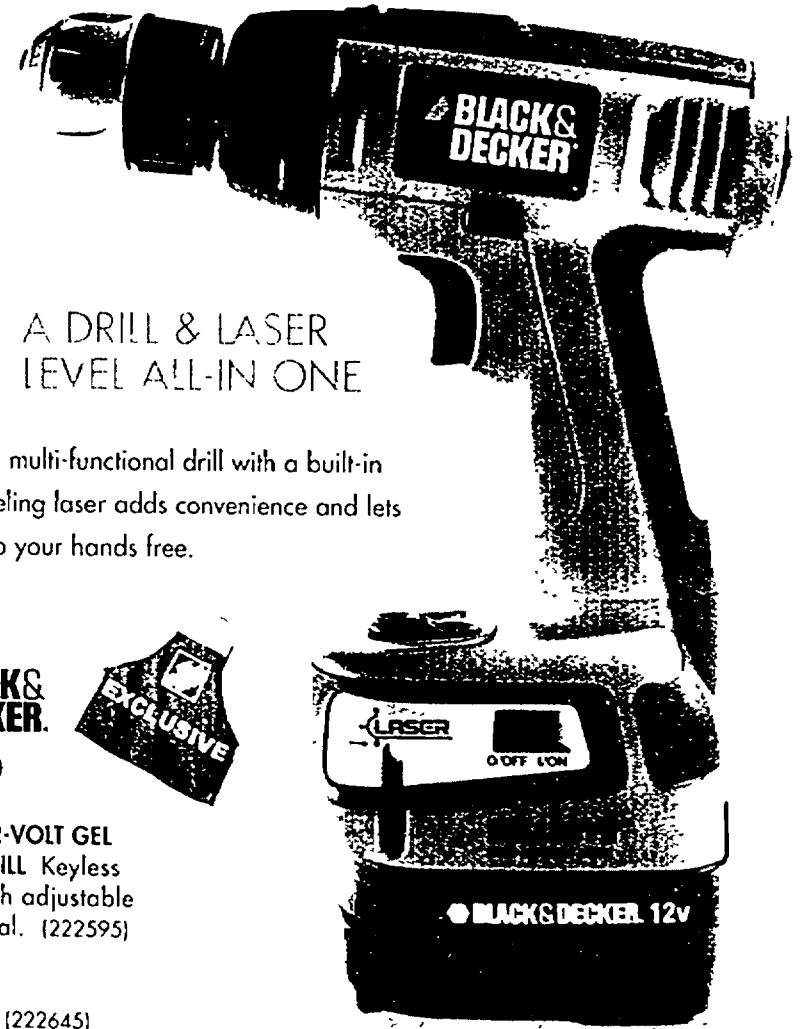
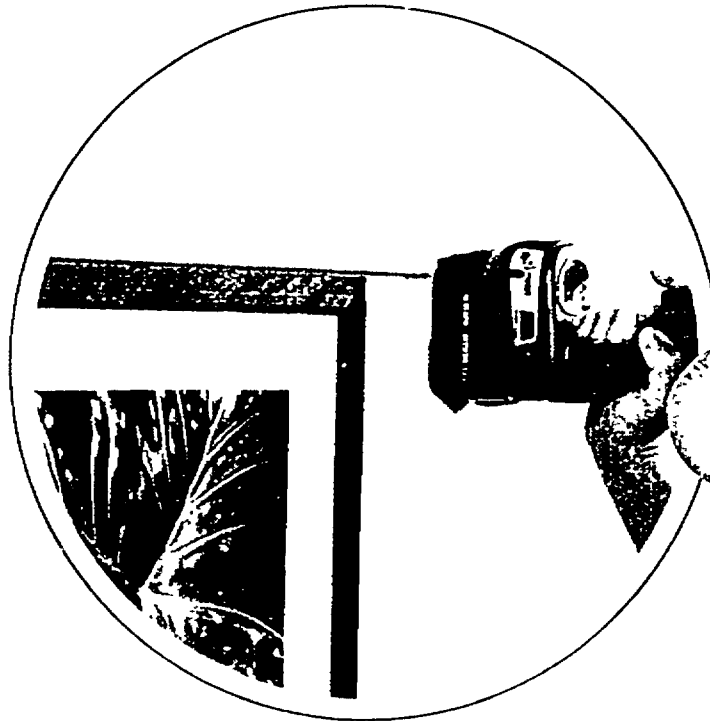
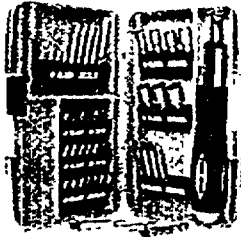

A DRILL & LASER  
LEVEL ALL-IN ONE

Powerful multi-functional drill with a built-in auto-leveling laser adds convenience and lets you keep your hands free.

BLACK & DECKER

\$19<sup>97</sup>  
ONLY \$3.99  
PER BLADE  
7-1/4" 24-TOOTH  
SAW BLADES  
(762197)

5 PACK



GEL GRIP  
Relieves hand  
fatigue and lets  
you keep control

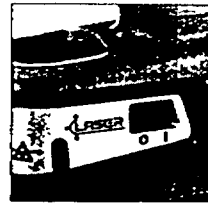

BULLSEYE LASER LEVEL  
Provides 3-direction  
horizontal and vertical  
laser lines

BLACK & DECKER

\$49

NEW 12-VOLT GEL  
LASER DRILL Keyless  
chuck with adjustable  
torque dial. (222595)

\$79  
14-VOLT (222645)

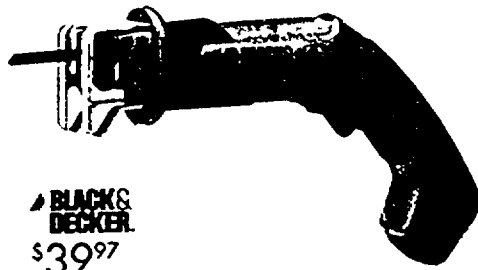

BLACK & DECKER

\$39<sup>97</sup>  
NEW 6-VOLT CORDLESS  
HANDSAW Cordless Convenience.  
Go anywhere utility. (222891)



BLACK & DECKER

\$19<sup>97</sup>  
NEW LOWER PRICE  
3.6-VOLT POWERED SCISSORS  
Cordless Power (286270)



POWER TAPE  
MEASURE EXTENDS  
AUTOMATICALLY

Make one-handed measurements. The motorized tape measure extends automatically so you can keep your hands on the job.

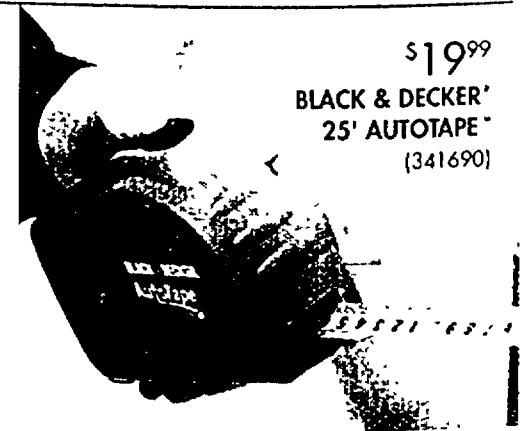

\$19<sup>99</sup>  
BLACK & DECKER®  
25' AUTOTAPE™  
(341690)

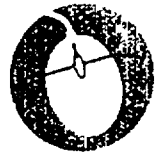

FIND THOUSANDS OF TOOLS AND  
ACCESSORIES ONLINE AT [HOMEDEPOT.COM](http://HOMEDEPOT.COM)

FROM BITS AND BLADES, TO  
SAWS, DRILLS, GENERATORS AND  
MORE; YOU'RE SURE TO FIND THE  
RIGHT TOOL FOR THE JOB.

# THE MOST VERSATILE CORDLESS TOOL SYSTEM.

**RYOBI ONE+**

**\$159**

**18-VOLT 5-PIECE TOOL COMBO WITH TORQUE DRILL** Includes cordless drill with magnetic bit holder and 2 bits. (200703)

**\$214**

ONLY \$10 PER MONTH  
**7-PIECE RENOVATOR COMBO** (167144)

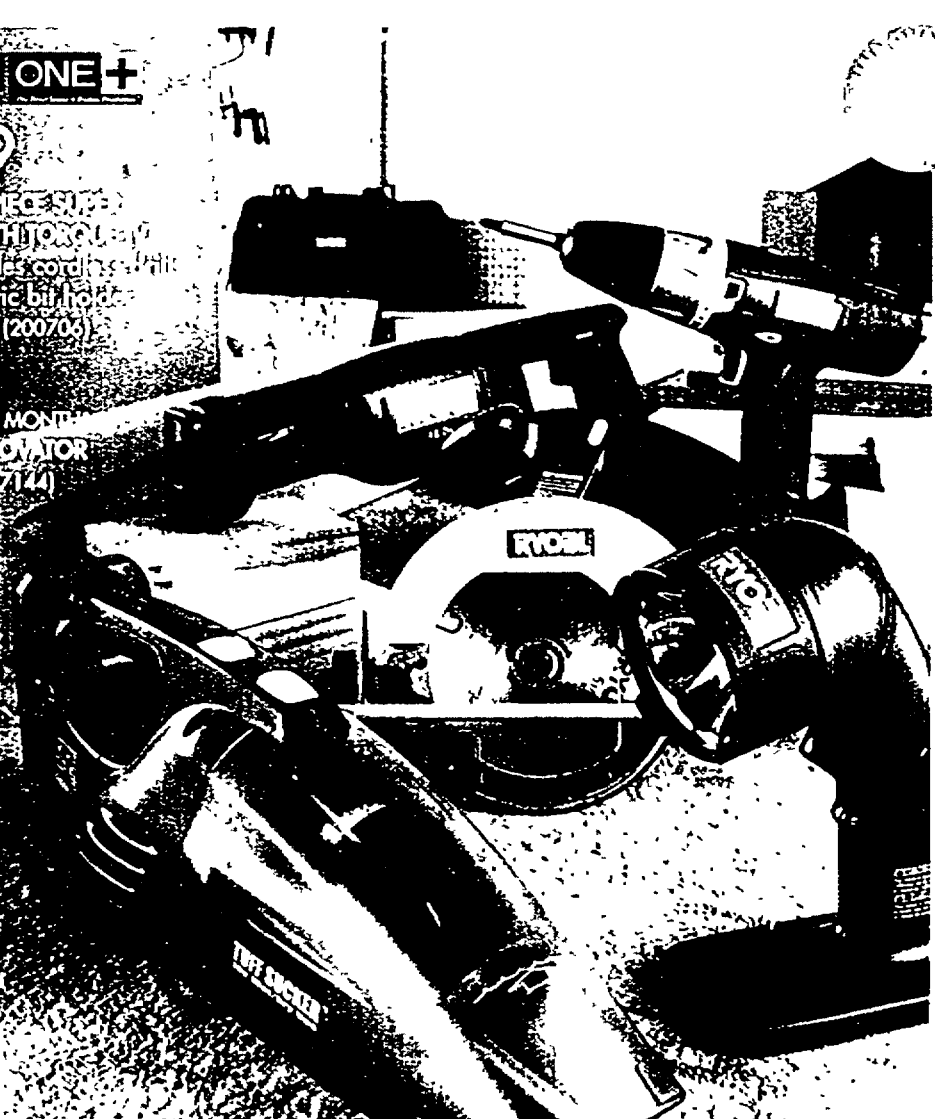

**RYOBI ONE+ SYSTEM  
OVER 25 TOOLS  
1 POWER SOURCE**

A RYOBI One+ combo kit gives you more expandable cordless tool options than anyone else. One common power source works with every 18-Volt Ryobi power tool ever made.

**\$69<sup>97</sup>**  
**IMPACT DRIVER**  
(725680)



**\$49<sup>97</sup>**  
**ORBITAL JIGSAW**  
(336202)



**\$59<sup>97</sup>**  
**HAMMER DRILL**  
(339146)



**\$59<sup>97</sup>**  
**RIGHT ANGLE DRILL** (483056)



**HOME SHOW 06**

**YOUR CHOICE  
\$19<sup>97</sup>**

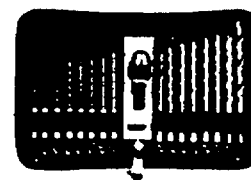

**RYOBI**  
**17-PIECE DRILL BIT KIT** Titanium coated, includes storage case. (113248)



**RYOBI**  
**60-PIECE DRILL/DRIVE ACCESSORY SET** (351288)

**RYOBI**  
**\$24<sup>96</sup>**  
**NEW 10" SAW BLADE 2-PACK**  
(577404)

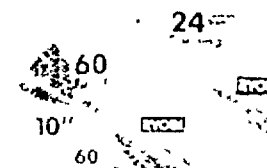

**RYOBI**

**\$29<sup>97</sup>** was \$49<sup>97</sup>  
**SPECIAL BUY**  
**7-1/4" CIRCULAR SAW 12 AMP.**  
(418540)



**RYOBI**

**\$39<sup>97</sup>** was \$59<sup>97</sup>  
**SPECIAL BUY**  
**12-VOLT CORDLESS DRILL KIT** 24-position clutch. (340364)



**\$149**  
**10" COMPOUND MITER SAW WITH LASER** (203608)

**\$99**  
**10" COMPOUND MITER SAW**  
(179469)

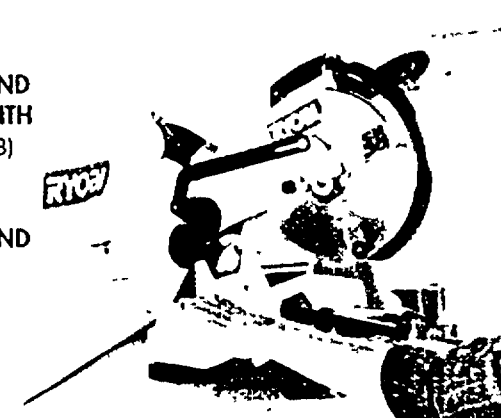

**6 MONTHS NO PAYMENTS, NO INTEREST**  
ON ANY TOOL AND HARDWARE PURCHASE OF \$299 OR MORE MADE ON THE HOME DEPOT CONSUMER CREDIT CARD.

\*When purchased with The Home Depot Consumer Credit Card. Additional terms apply. See page 23 for key credit terms.

SEE MORE INNOVATIONS ONLINE @ [HOMEDEPOT.COM/HOMESHOW](http://HOMEDEPOT.COM/HOMESHOW) 13

09/14/2006 12.3.4.9.14.18.19.23.25.26.27.28.30.34.34U.43.43U.45.50.57.60.89.97.102.115.136.173.176.177.178.246.282.290.303.310.327.330.335.338.392.403.405.447.448.10.15.15U.20.20U.39.39U.65.66.66.66.93.111.112.116.191.260.272.423.458.6.8U.12.21.21U.20.36.47.48.48U.63.87.104.106.226.64.67.72.75.101.106.109.127.131.139.143.156.157.158.164.185.206.207.208.234.235.237.247.262.276.298.300.304.314.322.323.332.342.366.371.383.391.451.452.453.5.8.13.16.17.40.42.58.73.113.122.129.147.148.152.160.163.1.67.171.175.211.212.230.231.233.249.302.307.308.312.329.331.347.348.349.355.361.367.421.424.433.44.51.54.76.77.94.190.195.204.213.244.306.316.324.400. PG 013- BASE n- PRICE 1



# CORDED POWER WITHOUT THE CORD.

**DEWALT**

**\$799**

ONLY \$23 PER MONTH\*  
36-VOLT LITHIUM-ION  
4-TOOL COMBO KIT  
Nano-Phosphate  
Lithium-Ion exclusive  
to DeWalt. 3x the  
battery cycle life.  
(431931)

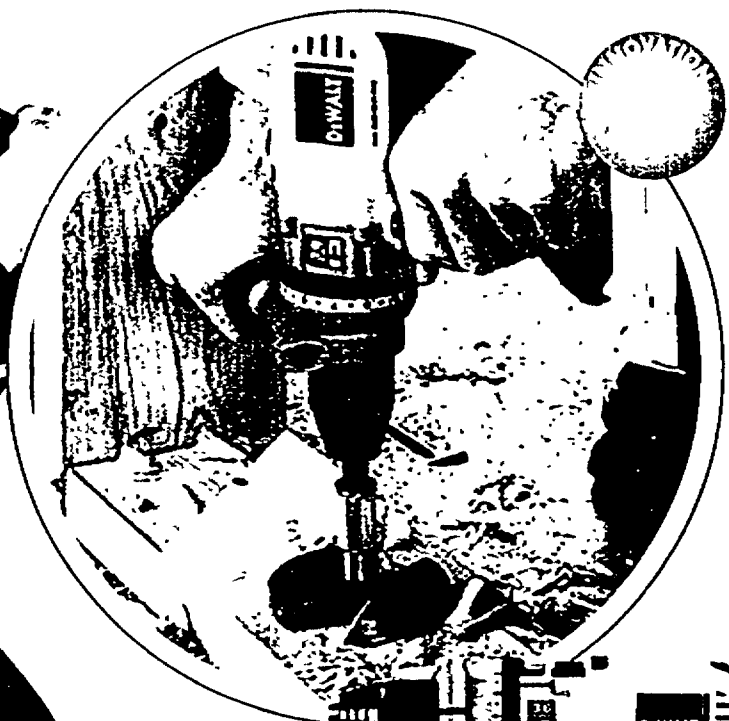
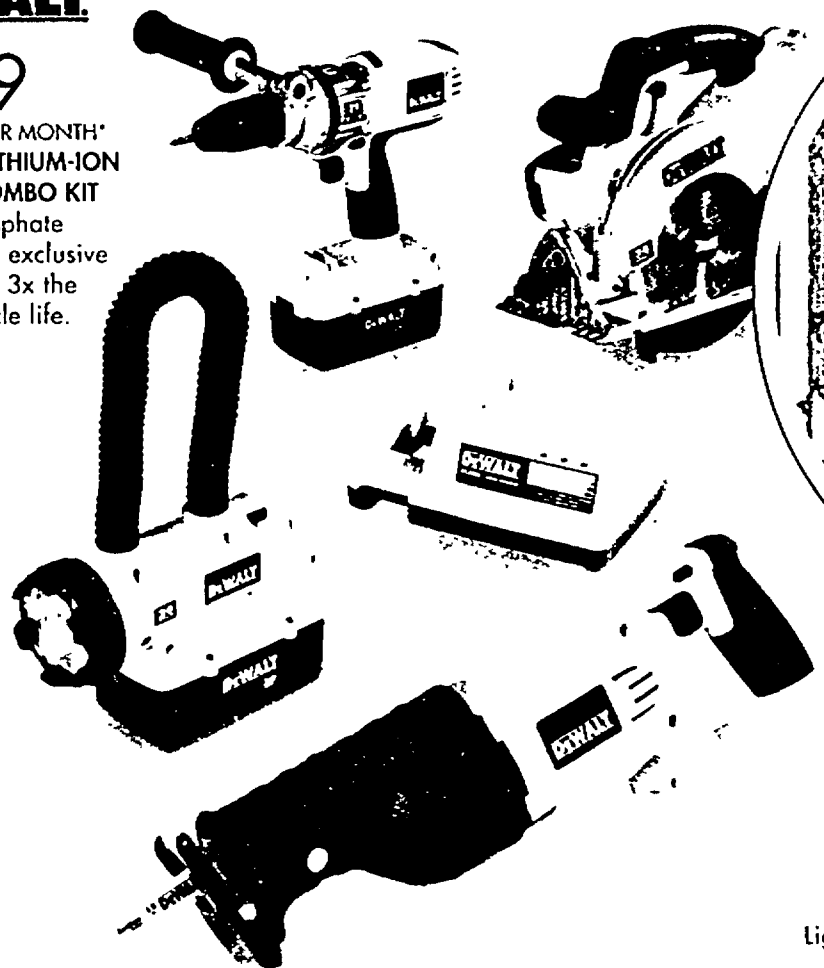

**\$449**

ONLY \$17 PER MONTH\*  
36-VOLT CORDLESS 1/2"  
LITHIUM-ION HAMMERDRILL  
Lightweight: 6.9 lbs. 750 unit  
watts out (632899)

2-3X MORE RUN TIME  
VS. 18-VOLT TOOLS

Light weight, yet incredibly powerful.  
DeWalt's 36-Volt Lithium-Ion tools  
provide the performance of a corded tool  
without the restriction of a power cord.

**DEWALT**

**\$248<sup>6</sup>**

EXCLUSIVE  
12-PIECE  
RECIPROCATING  
SAW-BLADE SET  
(276456)



**DEWALT**

**\$199<sup>7</sup>**

EXCLUSIVE  
14-PIECE  
TITANIUM  
PILOT POINT®  
DRILL BIT SET  
(385153)

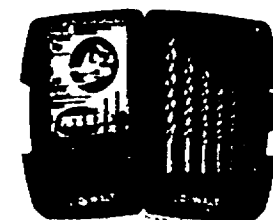

FREE 16-GAUGE  
NAILER. A  
1.50 VALUE

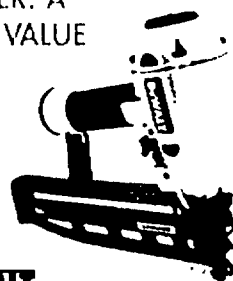

**DEWALT**

**\$649**

ONLY \$19 PER MONTH\*  
12" SLIDE COMPOUND MITER  
SAW Powerful 15 AMP,  
3600 RPM motor provides  
power and extended  
durability (190262)

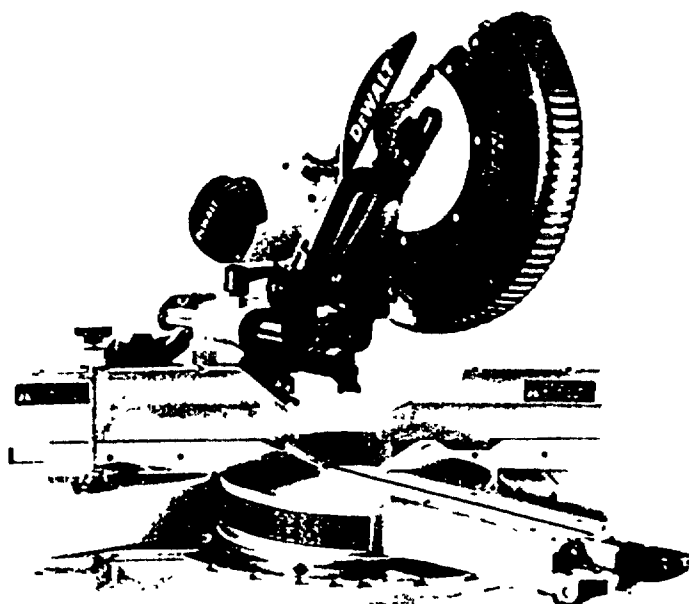

**DEWALT**

**\$499**

ONLY \$16 PER MONTH\*  
18-VOLT XRP4™  
4-PACK COMBO KIT  
Includes hammer drill, circular  
saw, reciprocating saw, floodlight,  
2 batteries, charger and case. (371918)

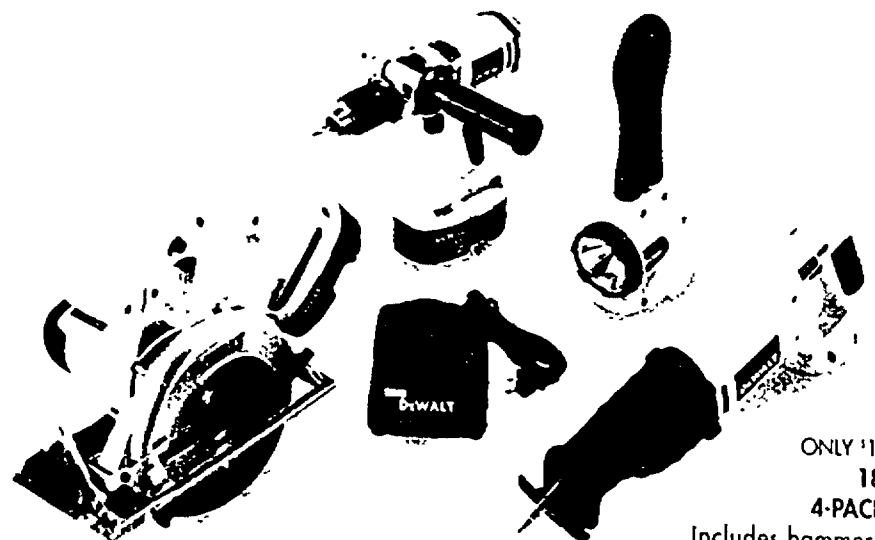

# TOOLS TO HELP YOU SAVE TIME & MONEY.

## BUY ANY OF THESE PNEUMATIC NAILERS & GET A FREE BOX OF NAILS\*\*

### HOME SHOW 06

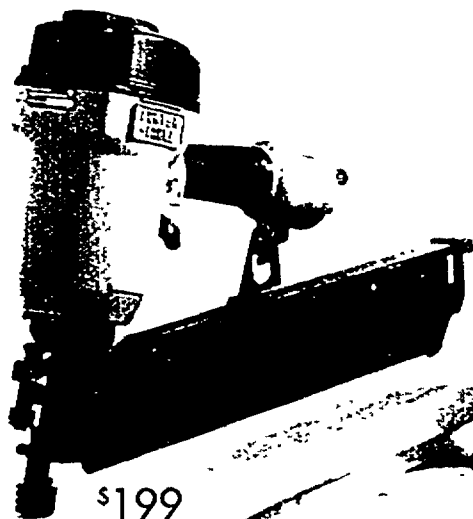

**\$199**  
ONLY \$10 PER MONTH\*  
PORTER CABLE 3-1/2"  
CLIPPED HEAD FRAMING  
NAILER (166779)

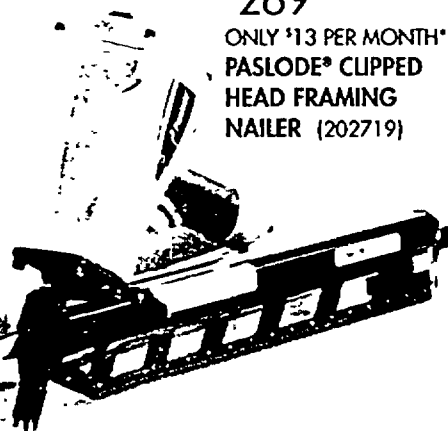

**\$269**  
ONLY \$13 PER MONTH\*  
PASLODE® CLIPPED  
HEAD FRAMING  
NAILER (202719)

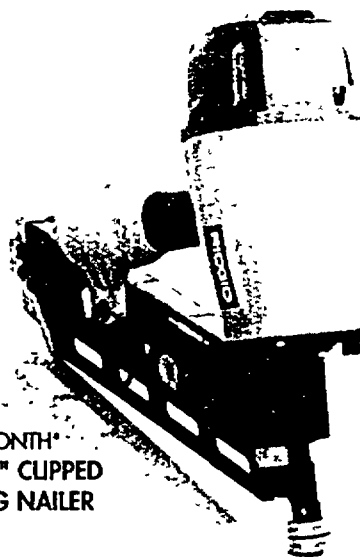

**\$259**  
ONLY \$13 PER MONTH\*  
RIDGID® 3-1/2" CLIPPED  
HEAD FRAMING NAILER  
(303011)

### FREE NAILS



3" x .120 Round Drive Nails (328293)

FREE FRAMING NAILER\*\*  
PURCHASE SELECT PALLETS (46 BOXES) OF  
FRAMING FASTENERS AND RECEIVE A FREE  
FRAMING NAILER INSTANTLY.

## FREE GIFT CARD UP TO \$259

BUY SELECT RIDGID COMPRESSORS & PNEUMATIC NAILERS, & RECEIVE A FREE GIFT CARD FOR THE VALUE OF THE NAILER TO THE HOME DEPOT BY MANUFACTURER MAIL-IN REBATE.\*\*

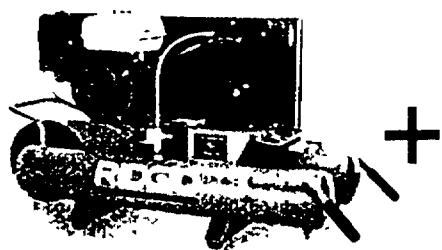

**\$699**  
ONLY \$22 PER MONTH\*  
RIDGID® 9-GALLON 5.5 HP HONDA OHV  
GAS POWERED AIR COMPRESSOR (250012)

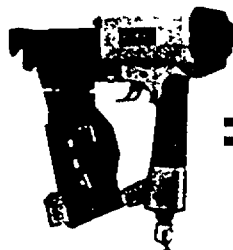

**\$249**  
ONLY \$13 PER MONTH\*  
RIDGID® ROOFING NAILER  
(303457 shown, or 303379)

FREE   
\$259 GIFT  
CARD

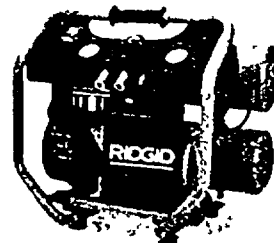

**\$259**  
ONLY \$13 PER MONTH\*  
RIDGID® 4.5-GALLON OIL-FREE  
TWIN-STACK COMPRESSOR (250638)

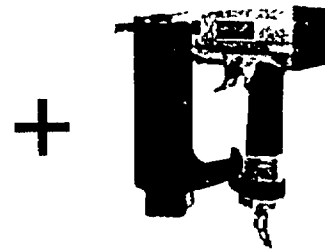

**\$109**  
RIDGID® BRAD NAILER  
OR FINISH STAPLER  
(303503 shown, or 301661)

FREE   
\$109 GIFT  
CARD



\*When purchased on The Home Depot Consumer Credit Card. Additional terms apply. See page 23 for details. \*\*Offer valid 8/31 10/4/06 valid on single receipt purchase only. May not be combined with any other offer. Rebate/rebate form must be presented to cashier at time of purchase to qualify. ♦♦Offer valid 8/31 10/4/06, purchase of select Pallets of Framing Fasteners (Primesource fasteners sku's 112 917, 619 148, 626 206 or Paslode fasteners sku 328 293) on a single receipt purchase at participating U.S. (including Alaska and Hawaii) The Home Depot stores. A free Framing Nailer (including Porter Cable 120 581 or 166 779, Paslode 202 719, RIDGID 303 379 or 303 011, Senko 4451 470, Bosch 377 457 or 224 014, Hitachi 324 253) will be given free instantly. No credit if offer refused. May not be combined with any other offer. See offer pad/rebate form, Store Associate or homedepot.com for complete details. Offer pad/rebate form must be presented to cashier at time of purchase to qualify. ††Offer valid 8/31 10/4/06 by mail-in offer on a single receipt purchase of any RIDGID compressor and RIDGID pneumatic nailer (a RIDGID Wheelbarrow Compressor G990135 (sku 250-012) and RIDGID Framing or Roofing Nailer R350RHA (sku 303-379), R350CHA (303 011), R175RNA (sku 303-457)), get a \$259 The Home Depot Gift Card. Buy A RIDGID Oil Free Twinstack Compressor OF45150 (sku 250-638) and RIDGID Brad Nailer or Finish Stapler R2138NA (sku 303-503) or R150FSA (sku 301-661) and get a The Home Depot Gift Card for \$109. A The Home Depot Gift Card will be given for each qualifying product purchased and submitted that meets offer requirements. See offer form or homedepot.com for complete details.

SEE MORE INNOVATIONS ONLINE @ [HOMEDEPOT.COM/HOMESHOW](http://HOMEDEPOT.COM/HOMESHOW) 15

# BEHR PAINT COLOR SOLUTIONS CENTER.

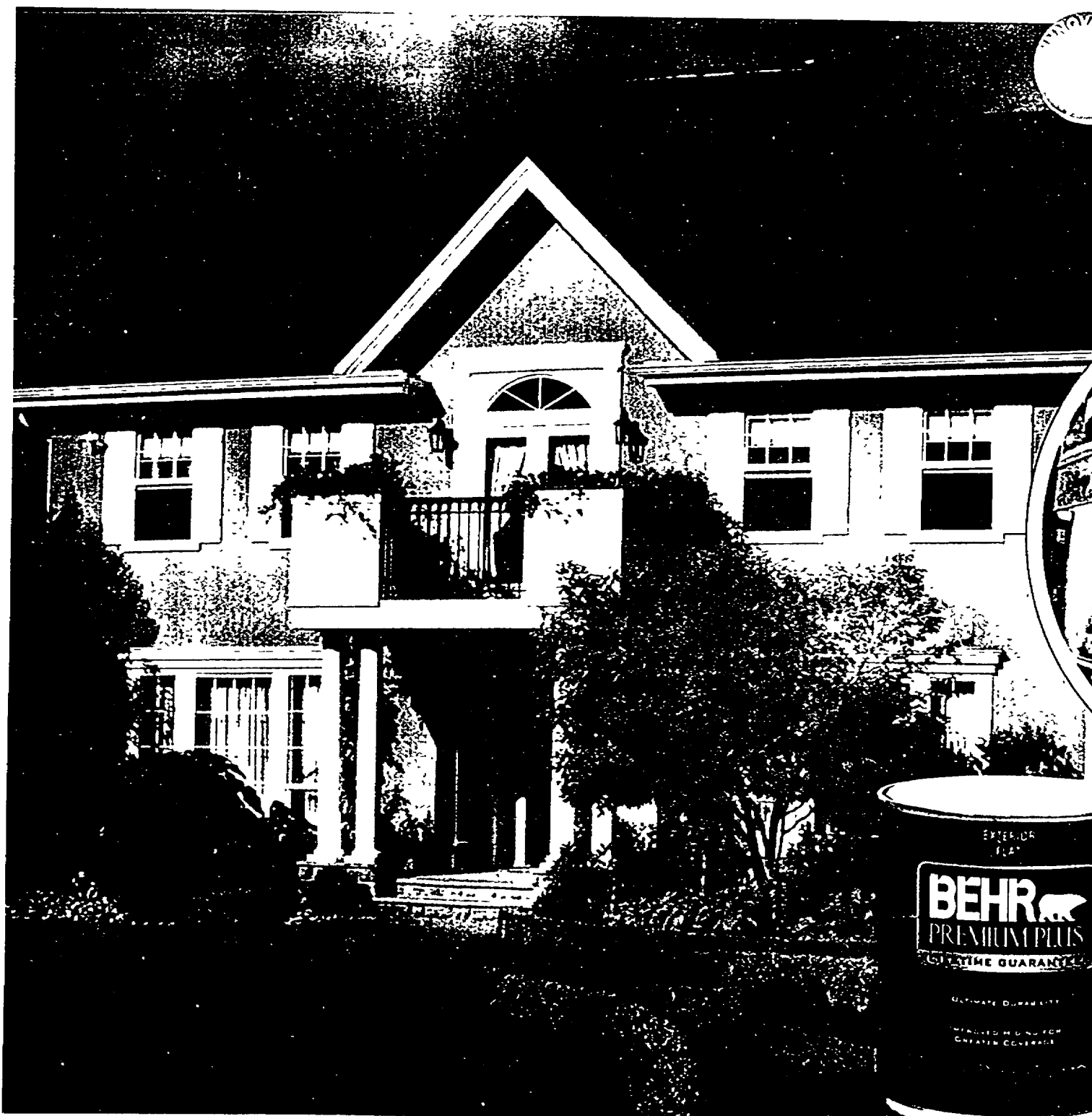

NEVER EASIER TO  
COORDINATE SHUTTERS,  
DOORS AND WALLS.

The revolutionary in store Color Solutions Center will coordinate the paint color for your project. Bring a swatch of paint or fabric into the store and BEHR's innovation will match any color to perfection.



**\$19.60** PER GALLON WHEN YOU  
BUY THE 5 GALLON

**BEHR® PREMIUM PLUS™  
EXTERIOR FLAT**

**\$98** 5-GALLON (154148)

**\$21.98** 1-GALLON (154121)



## INTERIOR AND EXTERIOR PAINTING DONE FOR YOU

**START TODAY: CALL 1-800-HOMEDEPOT**  
ENHANCE YOUR HOME WITHOUT LIFTING A FINGER. OUR NETWORK OF LICENSED PROFESSIONALS WILL TAKE CARE OF ALL THE DETAILS SO YOU DON'T HAVE TO. AND WE'LL GUARANTEE ALL WORK.!

# EXCLUSIVE WOOD CARE CENTER.



## THE FASTEST WAY TO COORDINATE YOUR EXTERIOR

Preview your colors before you paint. Just follow the easy step-by-step on-screen instructions for everything you need to complete the job like a pro

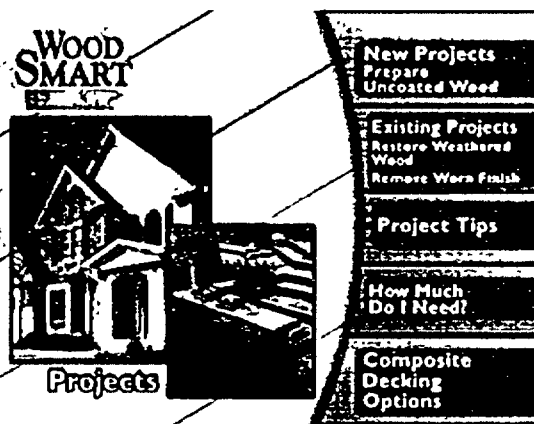

## HOME SHOW 06

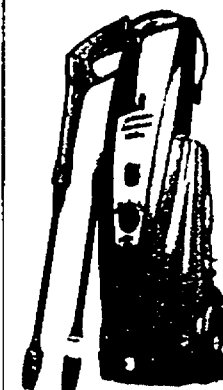

**HUSKY.**

\$169

HUSKY® ELECTRIC PRESSURE WASHER  
1800 PSI 2.0 GPM  
(242015)



Powered by **HONDA ENGINES** **Excel**

\$299

EXCEL GAS PRESSURE WASHER  
2500 PSI. 2.2 GPM 5.5 HP  
Honda engine  
(444217)

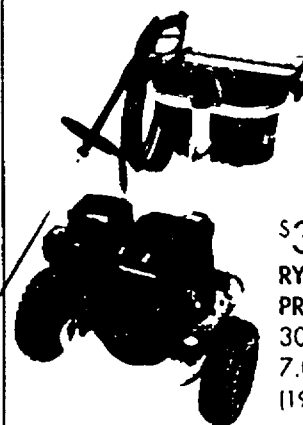

**RYOBI**

\$399 WAS \$498

RYOBI® GAS PRESSURE WASHER  
3000 PSI. 2.7 GPM.  
7.0 HP Subaru engine  
(1193753)

**BEHR**  
PAINTS AND STAINS

\$18.80 PER GALLON

WHEN YOU BUY THE 5 GALLON BEHR® DECK PLUS SEMI-TRANSPARENT WOOD STAIN. Mildew & UV ray resistant. Penetrating finish withstands foot traffic. Available in 83 colors. Ideal for decks, shakes, shingles, siding, roofs, fences and patio furniture

5-GALLON (334183) \$94

1-GALLON (334085) \$20.98



## THE HOME DEPOT TOOL RENTAL – OPEN 7 DAYS A WEEK

GET IN, GET OUT AND GET BACK TO WORK FAST WITH EVERY TOOL YOU NEED. RENT BY THE HOUR, DAY OR WEEK, ALL FOR A GUARANTEED LOW PRICE.\*

\*4 hour min. rental. Not available in all locations. See page 23 for details on our low price guarantee

SEE MORE INNOVATIONS ONLINE @ HOMEDEPOT.COM/HOMESHOW 17

# TIMELESS BEAUTY WITH TODAY'S TECHNOLOGY.

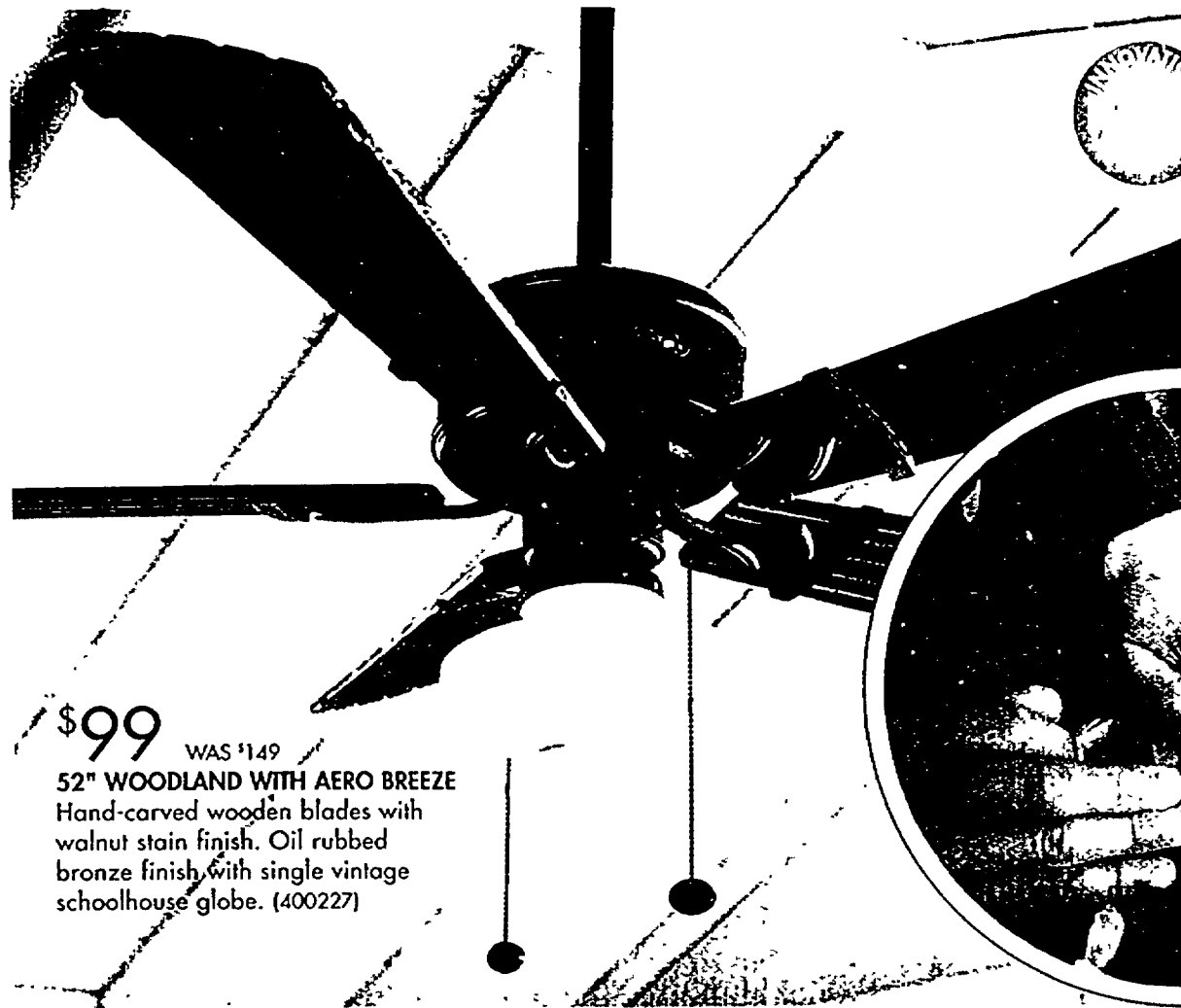

**HAND-CARVED WOOD BLADES  
THAT MOVE 40% MORE AIR**

Hampton Bay® fans combine the lost art of hand-crafted wood with a revolutionary blade design that lets you maintain your comfort and style while reducing energy costs

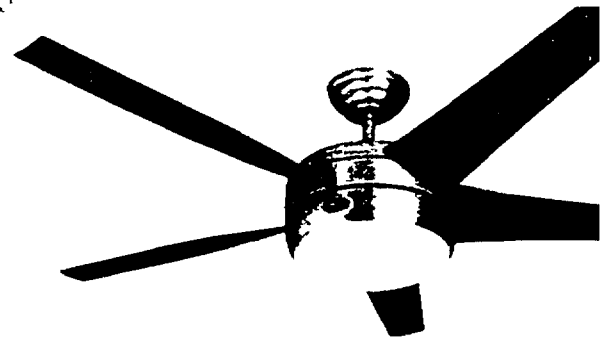

**\$139<sup>30</sup> WAS \$199**  
**HAMPTON BAY® 54" WINDWARD II™  
WITH REMOTE CONTROL**  
Brushed steel finish with black gossamer wind blades. Also, available in white. (523127)

**\$99**

WAS \$149

**52" WOODLAND WITH AERO BREEZE**  
Hand-carved wooden blades with walnut stain finish. Oil rubbed bronze finish with single vintage schoolhouse globe. (400227)

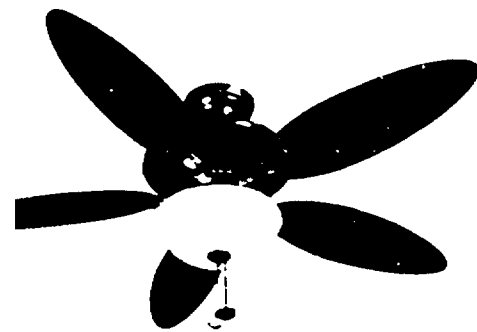

**\$139<sup>30</sup> WAS \$199**  
**HUNTER® 54" MOZAMBIQUE**  
Oil-rubbed bronze finish with alabaster bowl light kit. Decorative rope housing and teak blades. (462896)

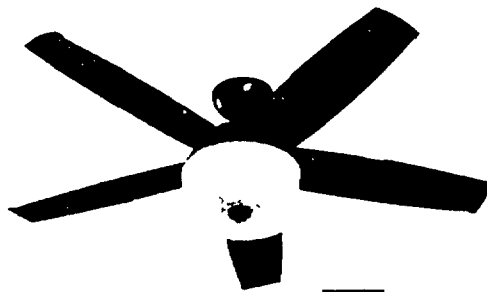

**\$99 WAS \$149**  
**HAMPTON BAY® 54" ROMANO II  
WITH REMOTE CONTROL**  
Transitional drum style fan in an oil brushed bronze finish. Single light kit with linen glass. (553295)

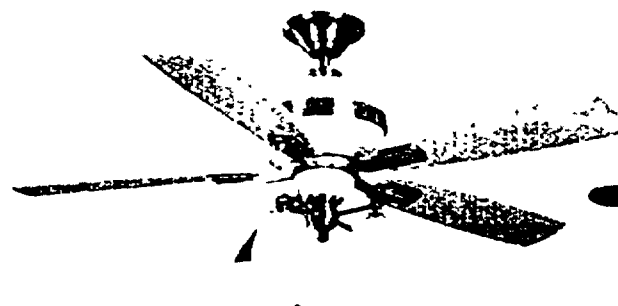

**\$69<sup>97</sup> WAS \$99**  
**HAMPTON BAY® 52" PORTLAND II**  
White and brushed nickel finish. Frosted opal glass light kit. Reversible white/maple blades. (762425)

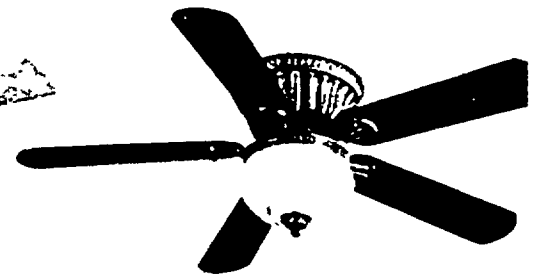

**\$55<sup>97</sup> WAS \$79**  
**HAMPTON BAY® 52" BELVEDERE  
WITH AERO BREEZE**  
Hand-painted aged gold finish with antique amber blown glass. Flush-mount design for low ceilings. (198374)

## 30% OFF SELECT IN-STOCK LIGHTING & CEILING FANS

Receive 30% off select in-stock ceiling fans and lighting at participating U.S., Puerto Rico and Virgin Islands The Home Depot Stores from September 14, 2006 - September 27, 2006. This offer is not valid on prior purchases and may not be combined with a different offer. No cash offer refused. Prices shown reflect discount. See store for details.

1,2,3,4,9,14,18,19,23,25,26,27,28,30,34,40,43,44,45,49,57,60,69,87,102,115,138,173,176,177,179,248,282,303,310,327,330,335,338,393,403,405,447,448,10,15,15U,20,20U,39,39U,65,66,68,69,93,111,112,116,191,260,272,423,459,6,8,12,21,21U,29,30,30U,31,31U,32,32U,33,33U,34,34U,35,35U,36,36U,37,37U,38,38U,39,39U,40,40U,41,41U,42,42U,43,43U,44,44U,45,45U,46,46U,47,47U,48,48U,49,49U,50,50U,51,51U,52,52U,53,53U,54,54U,55,55U,56,56U,57,57U,58,58U,59,59U,60,60U,61,61U,62,62U,63,63U,64,64U,65,65U,66,66U,67,67U,68,68U,69,69U,70,70U,71,71U,72,72U,73,73U,74,74U,75,75U,76,76U,77,77U,78,78U,79,79U,80,80U,81,81U,82,82U,83,83U,84,84U,85,85U,86,86U,87,87U,88,88U,89,89U,90,90U,91,91U,92,92U,93,93U,94,94U,95,95U,96,96U,97,97U,98,98U,99,99U,100,100U,101,101U,102,102U,103,103U,104,104U,105,105U,106,106U,107,107U,108,108U,109,109U,110,110U,111,111U,112,112U,113,113U,114,114U,115,115U,116,116U,117,117U,118,118U,119,119U,120,120U,121,121U,122,122U,123,123U,124,124U,125,125U,126,126U,127,127U,128,128U,129,129U,130,130U,131,131U,132,132U,133,133U,134,134U,135,135U,136,136U,137,137U,138,138U,139,139U,140,140U,141,141U,142,142U,143,143U,144,144U,145,145U,146,146U,147,147U,148,148U,149,149U,150,150U,151,151U,152,152U,153,153U,154,154U,155,155U,156,156U,157,157U,158,158U,159,159U,160,160U,161,161U,162,162U,163,163U,164,164U,165,165U,166,166U,167,167U,168,168U,169,169U,170,170U,171,171U,172,172U,173,173U,174,174U,175,175U,176,176U,177,177U,178,178U,179,179U,180,180U,181,181U,182,182U,183,183U,184,184U,185,185U,186,186U,187,187U,188,188U,189,189U,190,190U,191,191U,192,192U,193,193U,194,194U,195,195U,196,196U,197,197U,198,198U,199,199U,200,200U,201,201U,202,202U,203,203U,204,204U,205,205U,206,206U,207,207U,208,208U,209,209U,210,210U,211,211U,212,212U,213,213U,214,214U,215,215U,216,216U,217,217U,218,218U,219,219U,220,220U,221,221U,222,222U,223,223U,224,224U,225,225U,226,226U,227,227U,228,228U,229,229U,230,230U,231,231U,232,232U,233,233U,234,234U,235,235U,236,236U,237,237U,238,238U,239,239U,240,240U,241,241U,242,242U,243,243U,244,244U,245,245U,246,246U,247,247U,248,248U,249,249U,250,250U,251,251U,252,252U,253,253U,254,254U,255,255U,256,256U,257,257U,258,258U,259,259U,260,260U,261,261U,262,262U,263,263U,264,264U,265,265U,266,266U,267,267U,268,268U,269,269U,270,270U,271,271U,272,272U,273,273U,274,274U,275,275U,276,276U,277,277U,278,278U,279,279U,280,280U,281,281U,282,282U,283,283U,284,284U,285,285U,286,286U,287,287U,288,288U,289,289U,290,290U,291,291U,292,292U,293,293U,294,294U,295,295U,296,296U,297,297U,298,298U,299,299U,300,300U,301,301U,302,302U,303,303U,304,304U,305,305U,306,306U,307,307U,308,308U,309,309U,310,310U,311,311U,312,312U,313,313U,314,314U,315,315U,316,316U,317,317U,318,318U,319,319U,320,320U,321,321U,322,322U,323,323U,324,324U,325,325U,326,326U,327,327U,328,328U,329,329U,330,330U,331,331U,332,332U,333,333U,334,334U,335,335U,336,336U,337,337U,338,338U,339,339U,340,340U,341,341U,342,342U,343,343U,344,344U,345,345U,346,346U,347,347U,348,348U,349,349U,350,350U,351,351U,352,352U,353,353U,354,354U,355,355U,356,356U,357,357U,358,358U,359,359U,360,360U,361,361U,362,362U,363,363U,364,364U,365,365U,366,366U,367,367U,368,368U,369,369U,370,370U,371,371U,372,372U,373,373U,374,374U,375,375U,376,376U,377,377U,378,378U,379,379U,380,380U,381,381U,382,382U,383,383U,384,384U,385,385U,386,386U,387,387U,388,388U,389,389U,390,390U,391,391U,392,392U,393,393U,394,394U,395,395U,396,396U,397,397U,398,398U,399,399U,400,400U,401,401U,402,402U,403,403U,404,404U,405,405U,406,406U,407,407U,408,408U,409,409U,410,410U,411,411U,412,412U,413,413U,414,414U,415,415U,416,416U,417,417U,418,418U,419,419U,420,420U,421,421U,422,422U,423,423U,424,424U,425,425U,426,426U,427,427U,428,428U,429,429U,430,430U,431,431U,432,432U,433,433U,434,434U,435,435U,436,436U,437,437U,438,438U,439,439U,440,440U,441,441U,442,442U,443,443U,444,444U,445,445U,446,446U,447,447U,448,448U,449,449U,450,450U,451,451U,452,452U,453,453U,454,454U,455,455U,456,456U,457,457U,458,458U,459,459U,460,460U,461,461U,462,462U,463,463U,464,464U,465,465U,466,466U,467,467U,468,468U,469,469U,470,470U,471,471U,472,472U,473,473U,474,474U,475,475U,476,476U,477,477U,478,478U,479,479U,480,480U,481,481U,482,482U,483,483U,484,484U,485,485U,486,486U,487,487U,488,488U,489,489U,490,490U,491,491U,492,492U,493,493U,494,494U,495,495U,496,496U,497,497U,498,498U,499,499U,500,500U,501,501U,502,502U,503,503U,504,504U,505,505U,506,506U,507,507U,508,508U,509,509U,510,510U,511,511U,512,512U,513,513U,514,514U,515,515U,516,516U,517,517U,518,518U,519,519U,520,520U,521,521U,522,522U,523,523U,524,524U,525,525U,526,526U,527,527U,528,528U,529,529U,530,530U,531,531U,532,532U,533,533U,534,534U,535,535U,536,536U,537,537U,538,538U,539,539U,540,540U,541,541U,542,542U,543,543U,544,544U,545,545U,546,546U,547,547U,548,548U,549,549U,550,550U,551,551U,552,552U,553,553U,554,554U,555,555U,556,556U,557,557U,558,558U,559,559U,560,560U,561,561U,562,562U,563,563U,564,564U,565,565U,566,566U,567,567U,568,568U,569,569U,570,570U,571,571U,572,572U,573,573U,574,574U,575,575U,576,576U,577,577U,578,578U,579,579U,580,580U,581,581U,582,582U,583,583U,584,584U,585,585U,586,586U,587,587U,588,588U,589,589U,590,590U,591,591U,592,592U,593,593U,594,594U,595,595U,596,596U,597,597U,598,598U,599,599U,600,600U,601,601U,602,602U,603,603U,604,604U,605,605U,606,606U,607,607U,608,608U,609,609U,610,610U,611,611U,612,612U,613,613U,614,614U,615,615U,616,616U,617,617U,618,618U,619,619U,620,620U,621,621U,622,622U,623,623U,624,624U,625,625U,626,626U,627,627U,628,628U,629,629U,630,630U,631,631U,632,632U,633,633U,634,634U,635,635U,636,636U,637,637U,638,638U,639,639U,640,640U,641,641U,642,642U,643,643U,644,644U,645,645U,646,646U,647,647U,648,648U,649,649U,650,650U,651,651U,652,652U,653,653U,654,654U,655,655U,656,656U,657,657U,658,658U,659,659U,660,660U,661,661U,662,662U,663,663U,664,664U,665,665U,666,666U,667,667U,668,668U,669,669U,670,670U,671,671U,672,672U,673,673U,674,674U,675,675U,676,676U,677,677U,678,678U,679,679U,680,680U,681,681U,682,682U,683,683U,684,684U,685,685U,686,686U,687,687U,688,688U,689,689U,690,690U,691,691U,692,692U,693,693U,694,694U,695,695U,696,696U,697,697U,698,698U,699,699U,700,700U,701,701U,702,702U,703,703U,704,704U,705,705U,706,706U,707,707U,708,708U,709,709U,710,710U,711,711U,712,712U,713,713U,714,714U,715,715U,716,716U,717,717U,718,718U,719,719U,720,720U,721,721U,722,722U,723,723U,724,724U,725,725U,726,726U,727,727U,728,728U,729,729U,730,730U,731,731U,732,732U,733,733U,734,734U,735,735U,736,736U,737,737U,738,738U,739,739U,740,740U,741,741U,742,742U,743,743U,744,744U,745,745U,746,746U,747,747U,748,748U,749,749U,750,750U,751,751U,752,752U,753,753U,754,754U,755,755U,756,756U,757,757U,758,758U,759,759U,760,760U,761,761U,762,762U,763,763U,764,764U,765,765U,766,766U,767,767U,768,768U,769,769U,770,770U,771,771U,772,772U,773,773U,774,774U,775,775U,776,776U,777,777U,778,778U,779,779U,780,780U,781,781U,782,782U,783,783U,784,784U,785,785U,786,786U,787,787U,788,788U,789,789U,790,790U,791,791U,792,792U,793,793U,794,794U,795,795U,796,796U,797,797U,798,798U,799,799U,800,800U,801,801U,802,802U,803,803U,804,804U,805,805U,806,806U,807,807U,808,808U,809,809U,810,810U,811,811U,812,812U,813,813U,814,814U,815,815U,816,816U,817,817U,818,818U,819,819U,820,820U,821,821U,822,822U,823,823U,824,824U,825,825U,826,826U,827,827U,828,828U,829,829U,830,830U,831,831U,832,832U,833,833U,834,834U,835,835U,836,836U,837,837U,838,838U,839,839U,840,840U,841,841U,842,842U,843,843U,844,844U,845,845U,846,846U,847,847U,848,848U,849,849U,850,850U,851,851U,852,852U,853,853U,854,854U,855,855U,856,856U,857,857U,858,858U,859,859U,860,860U,861,861U,862,862U,863,863U,864,864U,865,865U,866,866U,867,867U,868,868U,869,869U,870,870U,871,871U,872,872U,873,873U,874,874U,875,875U,876,876U,877,877U,878,878U,879,879U,880,880U,881,881U,882,882U,883,883U,884,884U,885,885U,886,886U,887,887U,888,888U,889,889U,890,890U,891,891U,892,892U,893,893U,894,894U,895,895U,896,896U,897,897U,898,898U,899,899U,900,900U,901,901U,902,902U,903,903U,904,904U,905,905U,906,906U,907,907U,908,908U,909,909U,910,910U,911,911U,912,912U,913,913U,914,914U,915,915U,916,916U,917,917U,918,918U,919,919U,920,920U,921,921U,922,922U,923,923U,924,924U,925,925U,926,926U,927,927U,928,928U,929,929U,930,930U,931,931U,932,932U,933,933U,934,934U,935,935U,936,936U,937,937U,938,938U,939,939U,940,940U,941,941U,942,942U,943,943U,944,944U,945,945U,946,946U,947,947U,948,948U,949,949U,950,950U,951,951U,952,952U,953,953U,954,954U,955,955U,956,956U,957,957U,958,958U,959,959U,960,960U,961,961U,962,962U,963,963U,964,964U,965,965U,966,966U,967,967U,968,968U,969,969U,970,970U,971,971U,972,972U,973,973U,974,974U,975,975U,976,976U,977,977U,978,978U,979,979U,980,980U,981,981U,982,982U,983,983U,984,984U,985,985U,986,986U,987,987U,988,988U,989,989U,990,990U,991,991U,992,992U,993,993U,994,994U,995,995U,996,996U,997,997U,998,998U,999,999U,1000,1000U,1001,1001U,1002,1002U,1003,1003U,1004,1004U,1005,1005U,1006,1006U,1007,1007U,1008,1008U,1009,1009U,1010,1010U,1011,1011U,1012,1012U,1013,1013U,1014,1014U,1015,1015U,1016,1016U,1017,1017U,1018,1018U,1019,1019U,1020,1020U,1021,1021U,1022,1022U,1023,1023U,1024,1024U,1025,1025U,1026,1026U,1027,1027U,1028,1028U,1029,1029U,1030,1030U,1031,1031U,1032,1032U,1033,1033U,1034,1034U,1035,1035U,1036,1036U,1037,1037U,1038,1038U,1039,1039U,1040,1040U,1041,1041U,1042,1042U,1043,1043U,1044,1044U,1045,1045U,1046,1046U,1047,1047U,1048,1048U,1049,1049U,1050,1050U,1051,1051U,1052,1052U,1053,1053U,1054,1054U,1055,1055U,1056,1056U,1057,1057U,1058,1058U,1059,1059U,1060,1060U,1061,1061U,1062,1062U,1063,1063U,1064,1064U,1065,1065U,1066,1066U,1067,1067U,1068,1068U,1069,1069U,1070,1070U,1071,1071U,1072,1072U,1073,1073U,1074,1074U,1075,1075U,1076,1076U,1077,1077U,1078,1078U,1079,1079U,1080,1080U,1081,1081U,1082,1082U,1083,1083U,1084,1084U,1085,1085U,1086,1086U,1087,1087U,1088,1088U,1089,1089U,1090,1090U,1091,1091U,1092,1092U,1093,1093U,1094,1094U,1095,1095U,1096,1096U,1097,1097U,1098,1098U,1099,1099U,1100,1100U,1101,1101U,1102,1102U,1103,1103U,1104,1104U,1105,1105U,1106,1106U,1107,1107U,1108,1108U,1109,1109U,1110,1110U,1111,1111U,1112,1112U,1113,1113U,1114,1114U,1115,1115U,1116,1116U,1117,1117U,1118,1118U,1119,1119U,1120,1120U,1121,1121U,1122,1122U,1123,1123U,1124,1124U,1125,1125U,1126,1126U,1127,1127U,1128,1128U,1129,1129U,1130,1130U,1131,1131U,1132,1132U,1133,1133U,1134,1134U,1135,1135U,1136,1136U,1137,1137U,1138,1138U,1139,1139U,1140,1140U,1141,1141U,1142,1142U,1143,1143U,1144,1144U,1145,1145U,1146,1146U,1147,1147U,1148,1148U,1149,1149U,1150,1150U,1151,1151U,1152,1152U,1153,1153U,1154,1154U,1155,1155U,1156,1156U,1157,1157U,1158,1158U,1159,1159U,1160,1160U,1161,1161U,1162,1162U,1163,1163U,1164,1164U,1165,1165U,1166,1166U,1167,1167U,1168,1168U,1169,1169U,1

# SECURITY & CURB APPEAL MADE EASY.

HAMPTON BAY® CRANBROOK COLLECTION



ADD SECURITY WITHOUT SACRIFICING STYLE

Hampton Bay® decorative exterior lights with built-in motion sensors. Don't waste energy all day, just to come home to a lighted house at night.



HOME SHOW 06

\$109<sup>90</sup>

WAS \$157  
HAMPTON BAY®  
5-LIGHT AGED CRACKLE  
CHANDELIER (317977)

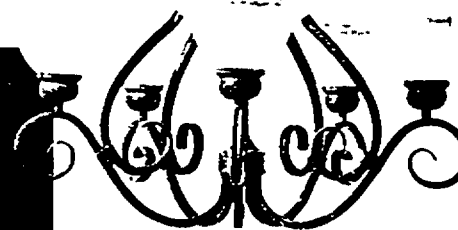

\$24<sup>47</sup> WAS \$34  
HAMPTON BAY®  
16' 3-LIGHT SATIN  
NICKEL FLUSHMOUNT  
(583526)



\$34<sup>97</sup> WAS \$49  
HAMPTON BAY®  
13' 3-LIGHT ANTIQUE  
BRASS SEMI-FLUSHMOUNT  
(287033)

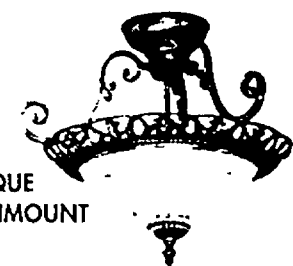

SILVER OXIDE COLLECTION



\$41<sup>97</sup>

WAS \$59  
WALL LANTERN  
(593009)

MOTION SENSOR  
WALL LANTERN (628280)  
\$55<sup>97</sup> WAS 79 (not shown)



\$48<sup>97</sup> WAS \$69  
POST LANTERN (592782)

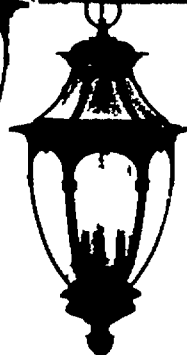

\$55<sup>97</sup> WAS \$79  
HANGING LANTERN  
(592777)

\$6<sup>93</sup> WAS \$89<sup>97</sup>  
MOTION SENSOR  
WALL LANTERN (334660)

WALL LANTERN (150241)  
\$41<sup>93</sup> WAS \$59 (not shown)

\$55<sup>93</sup> WAS \$79<sup>97</sup>  
POST LANTERN (150086)

\$55<sup>93</sup> WAS \$79<sup>97</sup>  
HANGING LANTERN  
(150114)

SPECIAL BUY

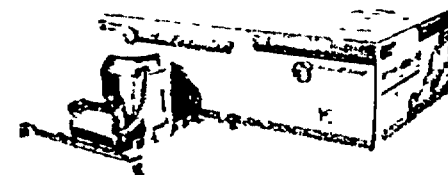

\$39<sup>50</sup> 6-PACK **Commercial Electric**

S30 SAVINGS FAST NAIL™  
AIR TIGHT CONTRACTOR PACK  
Double headed captured nail. Self-leveling  
foot Integral/easy t-bar clip Faster and  
easier installation (622146)



CEILING FANS AND INTERIOR LIGHTING INSTALLED FOR YOU START TODAY. VISIT YOUR LOCAL STORE. WE'LL GUARANTEE ALL THE WORK.\*

\*See page 23 for license numbers (where applicable). See contract for guarantee details. \*\*Receive 40% off select special order Hampton Bay ceiling fans and lighting at participating U.S. The Home Depot Stores from August 31, 2006 - October 4, 2006. This offer is not valid on prior purchases and may not be combined with any other offer. No credit if offer refused. Prices shown reflect discount. See stores for details.

40% OFF  
SELECT SPECIAL  
ORDER LIGHTING\*\*

SAVE ON SELECT LIGHTING & FANS FROM OUR HAMPTON BAY® SPECIAL ORDER CATALOG. FREE SHIPPING DIRECT TO YOUR HOME IN 5 DAYS!

# THE STAINLESS LOOK WITHOUT THE SMUDGES.

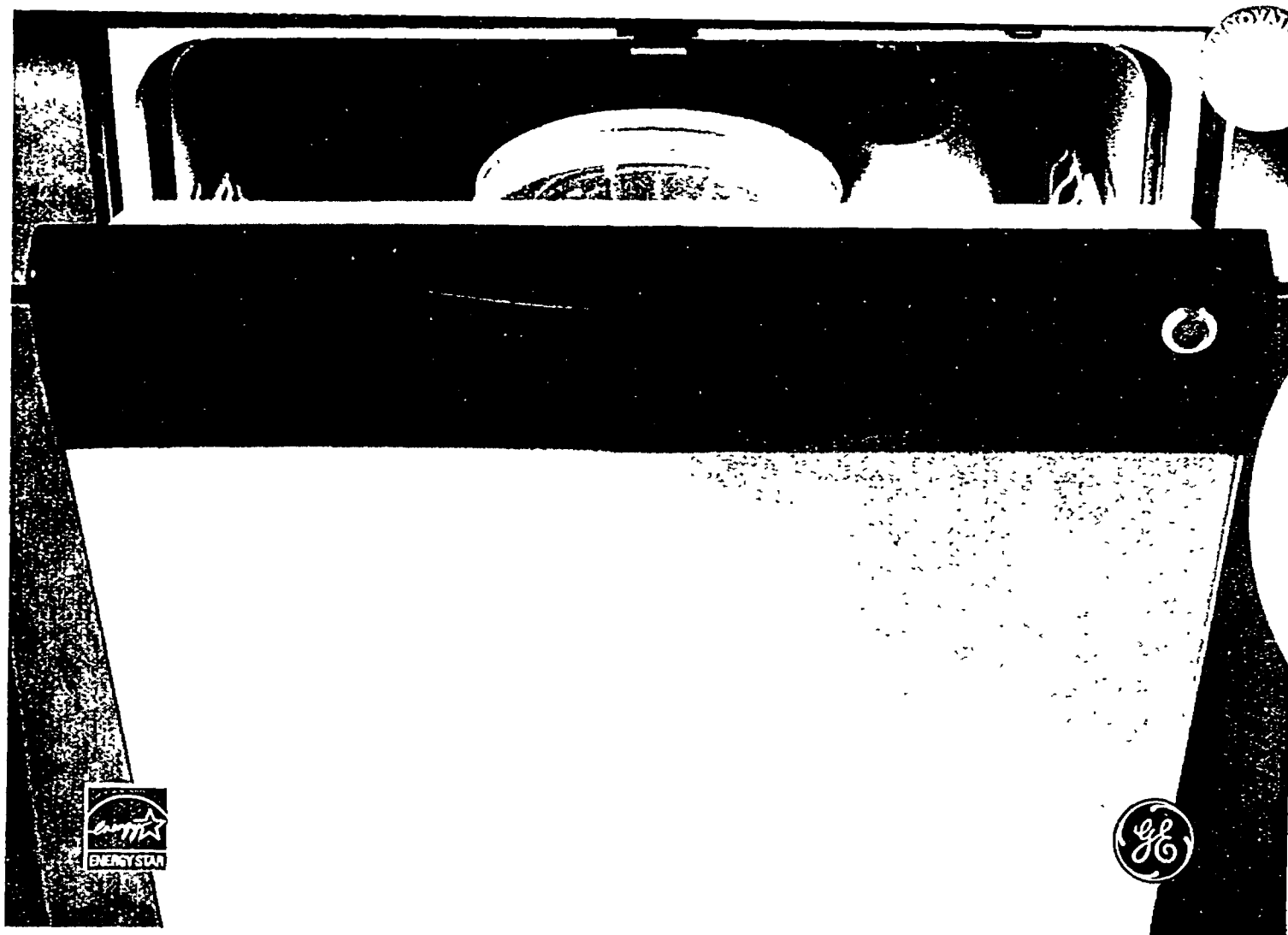

## APPLIANCES WITH THE CLEANSTEEL FINISH RESIST FINGERPRINTS

Unlike stainless, GE's\* innovative magnetic finish provides the great look of steel without the maintenance



**\$399** ONLY \$17 PER MONTH\*

**GE® CLEANSTEEL™ DISHWASHER**  
Giant tub with deluxe capacity racking.  
GHDA475MCS (Depot Direct 271521)

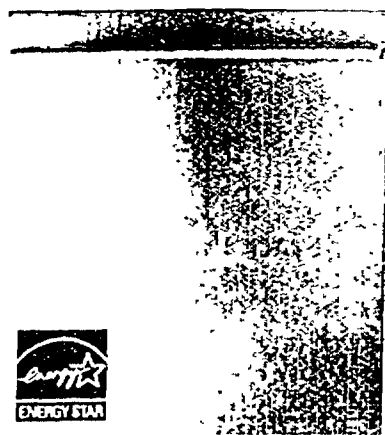

**LG**  
**LG STAINLESS STEEL FULLY INTEGRATED DISHWASHER**  
XL tall tub cleans up to 16 place settings at once  
LDF6810ST (Depot Direct 415894)

**\$849**  
ONLY \$23 PER MONTH\*



**MAYTAG Legacy Series**  
**EXCLUSIVE MAYTAG® LEGACY™ SERIES II DISHWASHER**  
Multiple, self-cleaning filtration system  
Microprocessor controls with 10 touch pads  
MDBH955AWS  
(Depot Direct 563970)

**\$549**  
ONLY \$16 PER MONTH\*

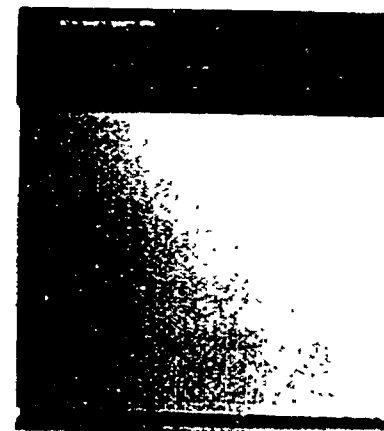

**HOTPOINT**  
**HOTPOINT® SILVER METALLIC DISHWASHER**  
Power Wash II system provides three-level wash action with powerful water jets  
HDA3440GSA (431780)  
Depot Direct 155027)

**\$299**  
ONLY \$13 PER MONTH\*

**12** NO PAYMENTS  
NO INTEREST FOR  
**MONTHS\***

ON ANY APPLIANCE PURCHASE OF \$299 OR MORE MADE ON THE HOME DEPOT CONSUMER CREDIT CARD FROM 9/7/06 - 9/17/06

**FREE GIFT CARD UP TO \$200†**  
RECEIVE A GIFT CARD TO THE HOME DEPOT BY MAIL-IN REBATE ON SELECT APPLIANCE PURCHASES OF \$299 OR MORE 9/14/06 THROUGH 10/9/06.

20 \*When purchased on The Home Depot Consumer Credit Card. Additional terms apply. See page 23 for key credit terms. †See page 22 for details.

09/14-2006  
1,2,3,4,9,14,18,19,23,25,26,27,28,30,34,34U,43,43U,45,50,57,60,69,97,102,115,136,173,176,177,178,246,282,290,303,310,327,330,335,338,392,403,405,447,448,10,15,15U,20,20U,39,39U,65,66,68,69,93,111,112,116,191,260,272,423,456,6,6U,12,21,21U,29,3  
6,47,48,49,53,57,198,229,64,42,75,75U,101,106,109,127,131,139,143,156,157,158,164,185,208,207,208,234,235,237,247,262,276,298,300,304,314,322,323,332,342,366,371,383,391,445,451,452,453,5,8,13,16,17,40,42,58,73,113,122,129,147,148,152,160,163  
1,67,171,175,211,212,230,231,233,249,302,307,308,312,329,331,347,348,349,355,361,367,421,424,433,443,444,51,54,76,77,94,190,195,204,213,244,306,316,324,400- PG 020 BASE R PHCL 1





# EXPERIENCE LG: PERFORMANCE. ART.

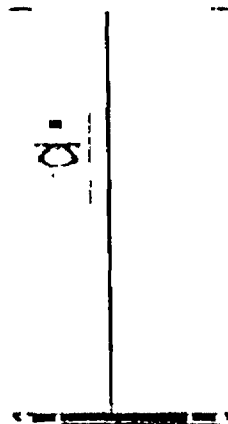

**25.0 CU. FT. SIDE-BY-SIDE REFRIGERATOR WITH DISPENSER**  
 External temperature controls with child lock. Sealed vegetable / fruit crisper. (Depot Direct 568427)  
**\$799**  
 ONLY \$23 PER MONTH\*

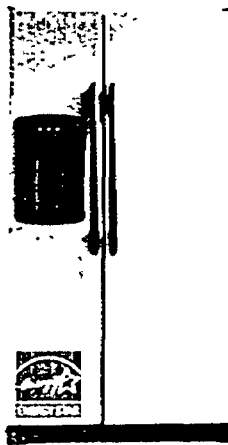

**MAYTAG MAYTAG® ULTRA STEEL 25.6 CU. FT. SIDE-BY-SIDE REFRIGERATOR**  
 Electronic cube/ crushed ice and water dispenser with a PuriClean® II retractable water/ ice filter. MSD2650KEU (Depot Direct 420991)  
**\$1099**  
 ONLY \$31 PER MONTH\*

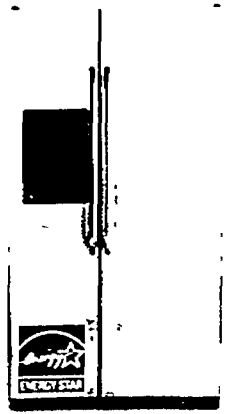

**GE® 25.4 CU. FT. SIDE-BY-SIDE REFRIGERATOR WITH DISPENSER**  
 Stainless steel exterior. External controls with temperature display. GSS25QSTSS (Depot Direct 419403)  
**\$1399**  
 ONLY \$39 PER MONTH\*



**ICE & WATER AT EYE-LEVEL WITH A FREEZER BELOW**

Now you can have it all in one stylish package. Smooth touch digital ice and water controls where you can see them, plus the convenience of a pullout-freezer at floor level.

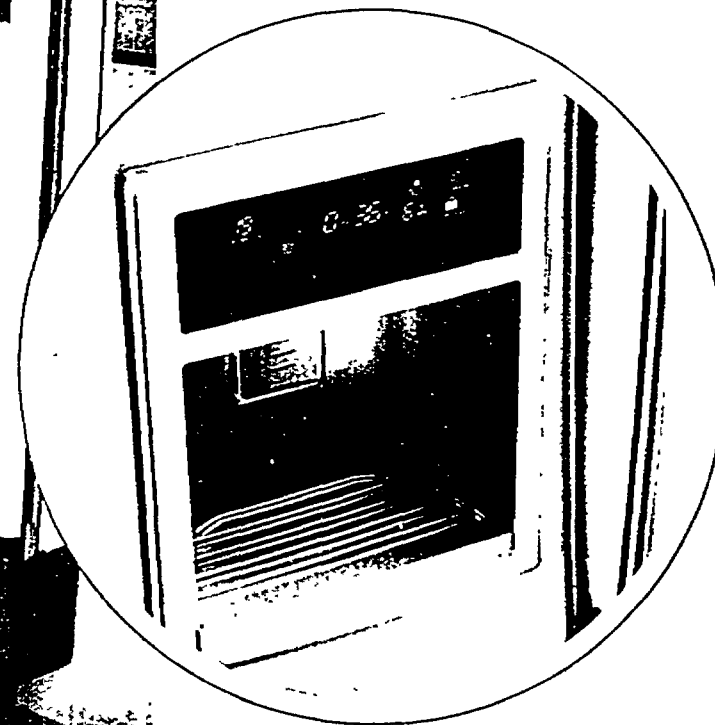

**LG**  
**\$2499** ONLY \$63 PER MONTH\*

**LG 24.7 CU. FT. FRENCH DOOR REFRIGERATOR WITH ICE AND WATER**  
 4 slide-out, spill-protector tempered glass shelves. 4 door baskets (3 clear gallon size, 1 small) and dairy corner. Wine rack, utility bin with egg tray. LFX25960ST (Depot Direct 317314)  
 Available in white, black and titanium



**12 NO PAYMENTS NO INTEREST FOR MONTHS\***

ON ANY APPLIANCE PURCHASE OF \$299 OR MORE MADE ON THE HOME DEPOT CONSUMER CREDIT CARD FROM 9/7/06 - 9/17/06.

**FREE GIFT CARD UP TO \$200<sup>††</sup>**  
 RECEIVE A GIFT CARD TO THE HOME DEPOT BY MAIL-IN REBATE ON SELECT APPLIANCE PURCHASES OF \$297 OR MORE 9/14/06 THROUGH 10/9/06.

\*When purchased on The Home Depot Consumer Credit Card. Additional terms apply. See page 23 for key credit terms. ††Buy select major appliances including select floor care, or \$477 to \$476 and get a \$50 Home Depot gift card by mail-in rebate. Buy appliances or \$477 to \$746 get a \$50 gift card, buy \$747 to \$999 get a \$75 gift card, buy \$997 to \$1496 get a \$100 gift card, buy \$1497 to \$1996 get a \$150 gift card. Or buy \$1997 and higher get a \$200 gift card. This offer is valid on single receipt purchases, not including delivery fees for or installation, between 9/14/06 - 10/9/06. †††Offer not valid at LGPO Group Center. Offer is not valid on LG Appliances. No credit if offer refused. See rebate form for details.

09/14/2006 12:34:09.14.18.19.23.25.26.27.28.30.34.34U.43.43U.45.50.57.60.89.97.102.115.138.173.176.177.178.246.282.290.303.310.327.330.335.338.392.403.405.447.448.10.20.20U.39.39U.65.66.68.68.93.111.112.116.191.2 60.272.6.8U.12.21.21U.29.36.47.48.48U.63.87.196.226.64.67.72.75.101.109.127.131.139.143.156.157.158.164.165.206.207.208.234.235.237.247.262.276.298.300.304.314.322.323.332.342.366.371.383.391.445.451. 452.453.5.8.13.16.17.40.42.58.73.113.122.129.147.148.152.160.163.167.171.175.211.212.230.231.233.249.302.307.308.312.329.331.347.348.349.355.361.367.421.424.433.443.444.51.54.76.77.94.190.195.204.213.2 44.306.316.324.400. PG 022- BASE & PRICE 1

# THE WASHER TALKS & THE DRYER LISTENS.

## HOME SHOW 06

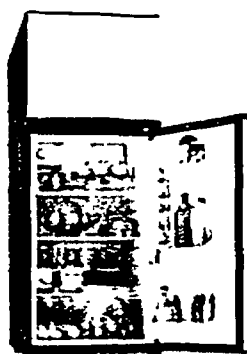

Magic Chef®  
\$349

ONLY \$13  
PER MONTH\*  
EXCLUSIVE  
MAGIC CHEF®  
10.0 CU. FT.  
REFRIGERATOR  
Stainless style  
with glass shelves  
MCBR1010GS  
(571178)



\$449

ONLY \$17  
PER MONTH\*  
GE® 18.2 CU. FT.  
TOP-FREEZER  
REFRIGERATOR  
Up-front temperature  
controls GTS18FBSWW  
(225334, Depot Direct  
222490)

Magic Chef®  
\$199

EXCLUSIVE  
MAGIC CHEF®  
7.2 CU. FT.  
CHEST FREEZER  
MCCF7WBX  
(539355)  
5.5 CU. FT.  
MCCF5WBX  
(569985) \$159



## A CLOTHES CARE SYSTEM THAT AUTOMATICALLY SELECTS THE RIGHT SETTINGS

The washer digitally communicates to the dryer and automatically determines which settings will deliver the best result for your clothes.

WASHER  
\$899

ONLY \$25 PER MONTH\*

DRYER  
\$749

ONLY \$22 PER MONTH\*

**LG 5 CYCLE LARGE CAPACITY WASHER AND DRYER**  
Electronic controls Automatic SenseClean and Automatic Sensor Dry for intelligent fabric care 3.42 cu ft IEC washer 7.0 cu ft LoDecibel Quiet System dryer. WM1815CS (Depot Direct 322673)  
DLE2515S (Depot Direct 323097)  
Optional dryer pedestals are available for purchase.

FIND THE STORE NEAREST YOU  
@ [HOMEDEPOT.COM](http://HOMEDEPOT.COM) OR  
1-800-HOMEDEPOT

BUY NOW, PAY LATER  
WITH EASY CREDIT

**\*Key Credit Terms: No Payments, No Interest Credit Offers:** (Offer not available with The Home Depot Rewards MasterCard)  
**FINANCE CHARGES** accrue from the date of purchase and all accrued **FINANCE CHARGES** will be added to your Account for the entire promotional period if qualifying purchases (including premiums for optional credit insurance) are not paid in full before the end of the promotional period or if you fail to make any required payment on your Account when due. Deferred period may vary by offer. See specific offer for details. Offer subject to credit approval. **APR** for purchases **21%** and **15.48%** for purchases of \$2,000 or more on The Home Depot Consumer Credit Card. The Default Rate **APR** for purchases of \$2,000 or more **19%**. **Minimum FINANCE CHARGE \$1.00.** **APR** for purchases **17.99%** and **12.99%** for purchases of \$2,000 or more on the EXPO Design Center Consumer Credit Card. The Default Rate **APR** for purchases of \$2,000 or more **17.99%**. **Minimum FINANCE CHARGE \$1.00.** See card agreement for details. Offer is for individuals not businesses. **Minimum Monthly Payments:** Payments shown are an estimate of your actual minimum monthly payments, and assume that you have no existing balance, make no additional purchases that you do not pay in full by the payment due date and no late or partial payments. Additional fees. Actual minimum monthly payments may vary. These payments apply only to the Home Depot Consumer Credit Card.

### TRUST OUR 10-DAY PRICE GUARANTEE

♦ If you find a lower price on an identical in-stock item from any retailer, we will match the price and beat it by 10%. Excludes clearance, counter-top, one-time, electronic, installation services and rebate offers. Excludes select flying products.

All installation services performed through The Home Depot, including plumbing services, are performed by independent contractors including licensed plumbing contractors, as applicable.

Service provided by The Home Depot authorized independent installation professionals. All service numbers held by or on behalf of Home Depot U.S.A., Inc. WA #WV036104, MN #BC-20147263, MI #2102119069, DETROIT #LIC2001-07767, IA #91302-04, OH-CLEVELAND HEIGHTS #3697, SHAKER HEIGHTS #4951, WI #940283 NE #23423 IEX/VG10%, LAFAYETTE, KY #11517

General merchandise prices may vary after 9/20/2006 if there are market variations (commodities excluded). We reserve the right to limit quantities to the amount reasonable for homeowners and our regular contractor customers. It is our policy to run truthful, accurate advertising. In the event of an error, we will make every reasonable effort to accommodate our customer. Details on any product availability available at store. ©2006 Home TLC, Inc. All rights reserved.

## FREE DELIVERY & HAUL AWAY\*\*

ON ANY APPLIANCE PURCHASE OF \$299 OR MORE.

A \$55 VALUE BY MAIL-IN REBATE.

\*\*Valid through 2/19/07 with any appliance purchase of \$299 or more, excluding taxes, warranty, delivery and installation fees. Delivered through Depot Direct and EXPO Quick Ship. Home Depot Direct and EXPO Quick Ship delivery services only. Delivery not available in some areas. Offer valid in U.S. including Alaska and Hawaii, and Puerto Rico only. Not valid in all communities. Offer only available at The Home Depot and EXPO Design Center stores. See rebate form for additional details. Max. rebate value is \$55.



## DREAM KITCHEN COME TRUE

USE YOUR MASTERCARD CARD AT THE HOME DEPOT BETWEEN  
SEPTEMBER 7 AND OCTOBER 31, 2006 AND YOUR DREAM KITCHEN COULD  
COME TRUE. VISIT [HOMEDEPOT.COM/MASTERCARD](http://HOMEDEPOT.COM/MASTERCARD) FOR MORE DETAILS

DISCOVER THE LATEST INNOVATIONS

# HOME SHOWS

THE WORLD'S LARGEST HOME SHOW

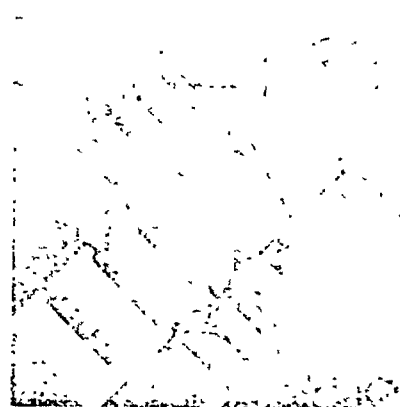

You can do it. We can help.

**\$99**

## SPECIAL BUY 18-VOLT 3-PIECE ONE+™ STARTER KIT

Includes cordless drill, 5-1/2" circular saw, sander, flashlight, 2 rechargeable battery packs, 1-hour diagnostic charger and tool bag (339208)

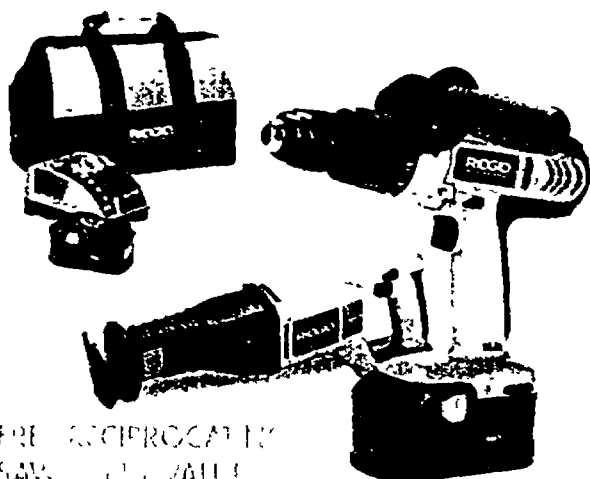

FREE RECIPROCATING  
SAW \$19 VALUE

**\$239**

RIDGID 18-VOLT CORDLESS 1/2" HAMMERDRILL  
Includes Rapid Max™ charger, Max 2.5 high  
capacity battery and tool bag (64026C)

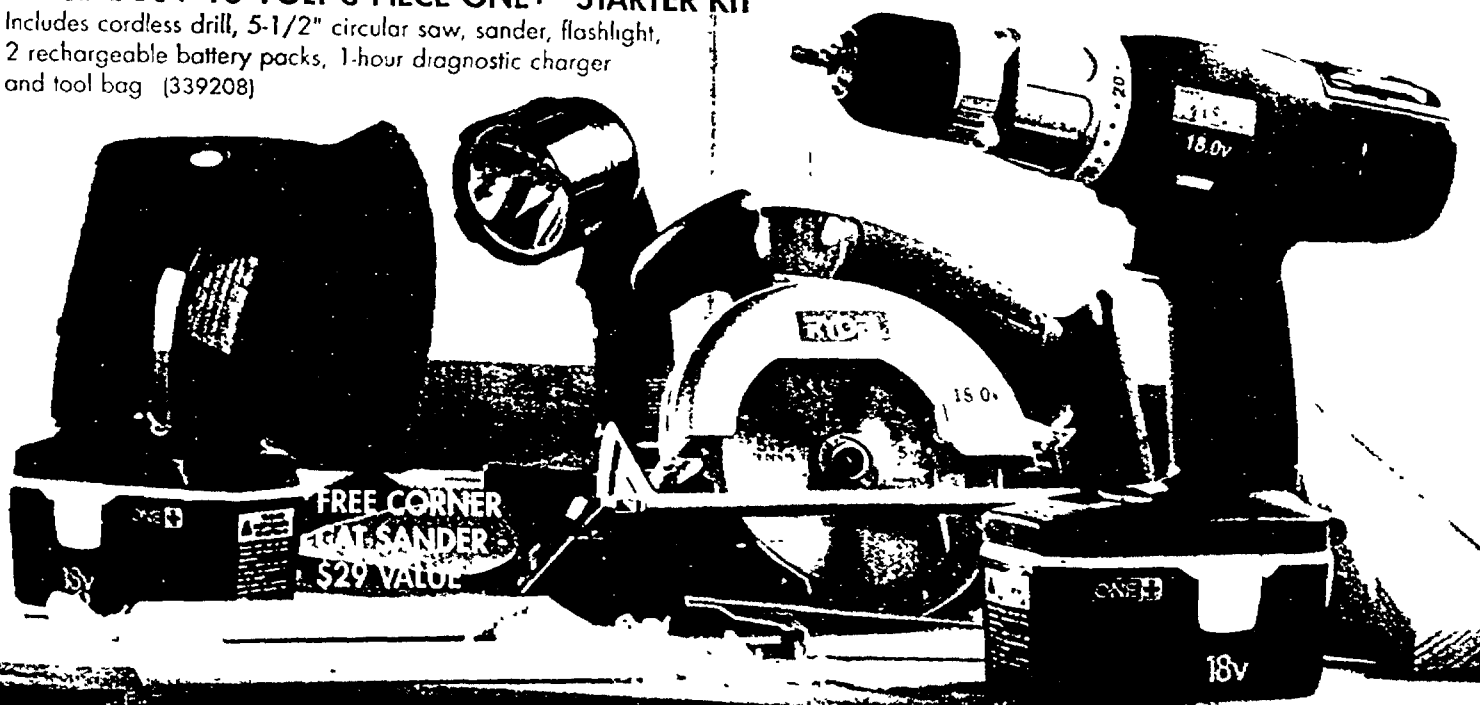

FREE CORNER  
SANDER  
\$29 VALUE



BUY 2  
GET 1 FREE  
**\$4.97**

SCOTT'S™ LAWN SOIL  
1.5 CU. FT. (228040)

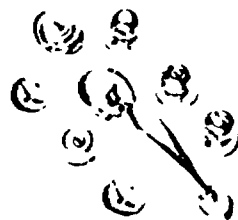

BUY 2  
GET 1 FREE  
**\$49.97**

KWIKSET™ DAKOTA HANDLESET  
Polished brass (354825)

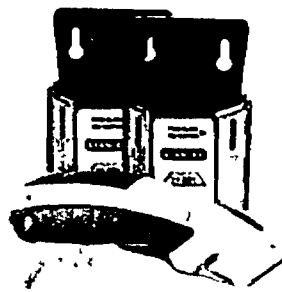

BUY 2  
GET 1 FREE  
**\$19.99**

STANLEY™ INSTANT  
CHANGE™ KNIFE (478456)



BUY 2  
GET 1 FREE  
**\$9.97**

BOSCH™ 7-1/4" 24-TOOTH  
CONSTRUCTION CARBIDE SAW  
BLADE (128494)



BUY 2  
GET 1 FREE  
**\$3.97**

STANLEY™ UTILITY PLUS GLOVES  
(167751)

09/14-2006 1.9 1.9 2.3 2.6 2.7 3.4 3.4U 4.3 4.3U 4.5 5.7 8.9 9.7 10.2 11.5 17.3 17.6 17.7 17.8 24.6 28.2 29.0 30.3 31.0 32.7 33.0 33.5 33.8 39.2 40.3 40.6 44.7 44.8 10.15 15.0 20.0 20.0 39.3 39.0 65.6 66.8 86.9 93.1 111.1 112.1 116.1 191.2 260.2 272.4 23.4 56.6 68.0 12.2 21.1 21.0 29.3 36.4 47.4 48.4 80.6 87.1 94.1 96.2 26.8 4.6 7.2 7.5 10.1 10.6 10.9 12.7 13.1 13.9 14.3 15.6 15.7 15.8 16.4 18.5 20.6 20.7 20.8 2.0 4.2 2.35 2.37 2.47 2.62 2.76 2.98 3.00 3.04 3.14 3.22 3.23 3.32 3.42 3.66 3.71 3.83 3.91 4.51 4.52 4.53 4.4 51.5 54.7 77.9 94.1 90.0 195.2 04.2 13.2 24.4 30.6 31.6 32.4 40.0 PC 024-BASE 8-PRICE 1

# OUTDOOR LIVING? HAD YOU ASKED.

## LANDSCAPE LIGHTING THAT INSTALLS IN SECONDS

No electricity needed. Safest and easiest kind of outdoor lighting to install. Ideal for remote areas and locations near water.

**Malibu® 2-Pack Solar Mission Light** (127850)

**\$49**  
In stock

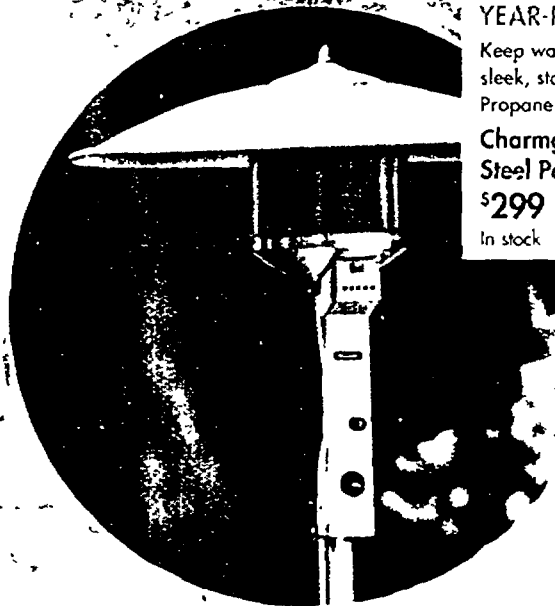

## ENJOY YOUR PATIO YEAR-ROUND

Keep warm in style with this sleek, stainless steel heater. Propane tank not included.

**Charmglow® Stainless Steel Patio Heater** (833325)

**\$299**  
In stock

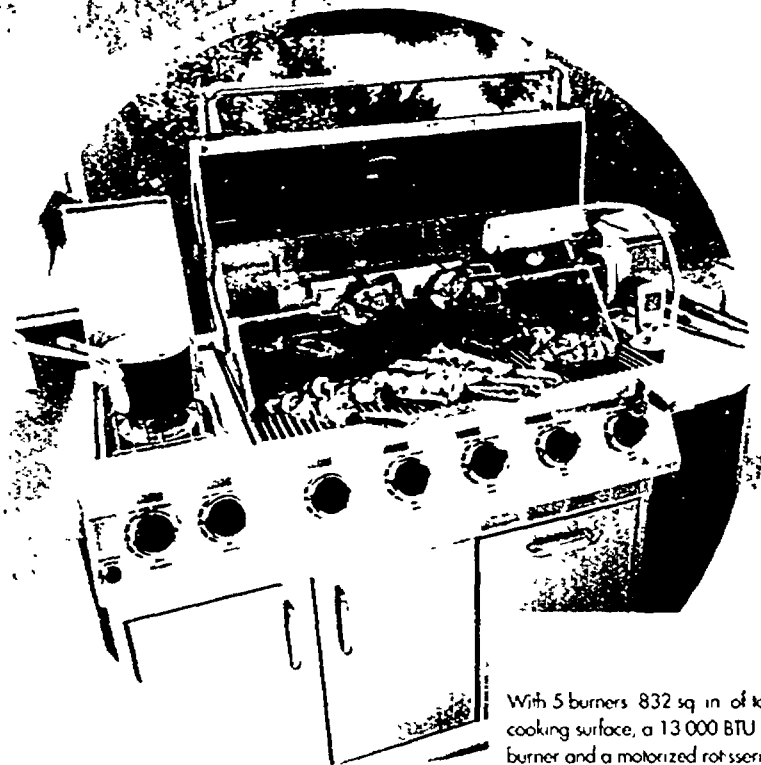

With 5 burners, 832 sq. in. of total cooking surface, a 13,000 BTU side burner and a motorized rotisserie, this grill is a chef's dream.

**Ducane® Professional 60,000 BTU Gas Grill**

(1596869)

**\$899**

In stock & at homedepot.com

## ANYTHING BUT JUST A CAMPFIRE

Ceramic logs set in a copper firebowl, surrounded by a mosaic slate table. 4 sling-back stationary rockers make sitting around the fire a true pleasure.

**Scottsdale 5-Piece Stone-Top Firepit Set**

(425413)

**\$1775**

Available in store by Special Order & at homedepot.com

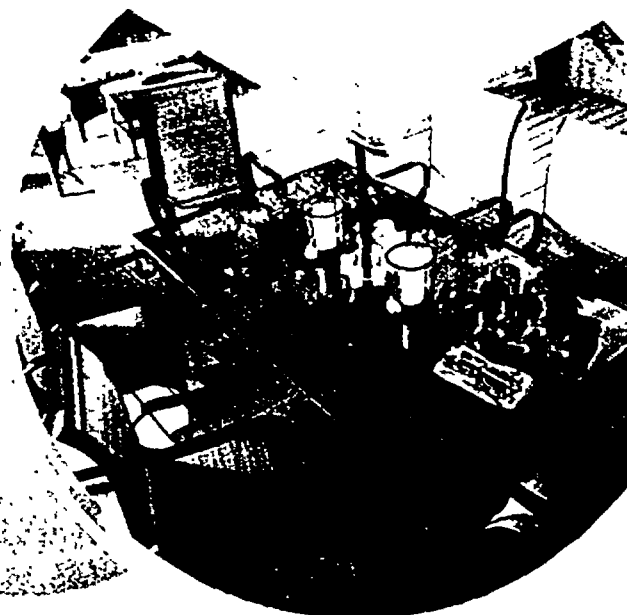

## CREATING YOUR OWN BACKYARD OASIS

The rectangular, smoke tempered inset glass tabletop has a modern design that makes the perfect back drop. Six sling back, quick dry dining chairs. Umbrella sold separately.

**Hampton Bay® Lasserre Patio Set** (443667)

**\$499**

Available in store by Special Order & at homedepot.com

# DISCOVER THE LATEST INNOVATIONS

49.48U.00.07.134.196.2  
3 024-BASE & PRICE 1

## JOIN US ALL MONTH FREE HOW-TO CLINICS

Learn the right way to do it with expert advice from our friendly staff.

**THE LATEST INTERIOR SOLUTIONS**  
THURSDAY SEPTEMBER 23 10:00 AM

**INNOVATIVE PAINT APPLICATIONS**  
SATURDAY SEPTEMBER 25 10:00 AM

**EXTERIOR SOLUTIONS FOR YOUR HOME**  
SUNDAY SEPTEMBER 27 10:00 AM

**KITCHEN & BATHROOM UPDATES**  
THURSDAY SEPTEMBER 29 10:00 AM

**CREATING A NEW ENTRANCE ROOM**  
SATURDAY SEPTEMBER 30 10:00 AM

**ENHANCING THE BURGERS YOU COOK**  
SUNDAY SEPTEMBER 31 10:00 AM

## EXCITING PRODUCTS DEMOS

Experience the latest innovation in the world. Stay on top of the latest trends and find out how to use them.

## EXPERIENCE THE HOME SHOW ONLINE

Take your virtual tour through our new online Virtual Home. Explore interactive demos, coordinated color and style choices, buy online or call with the click of a mouse.

**VISIT THE VIRTUAL HOME**  
[HOMEDEPOT.COM/HOMESHOW](http://HOMEDEPOT.COM/HOMESHOW)

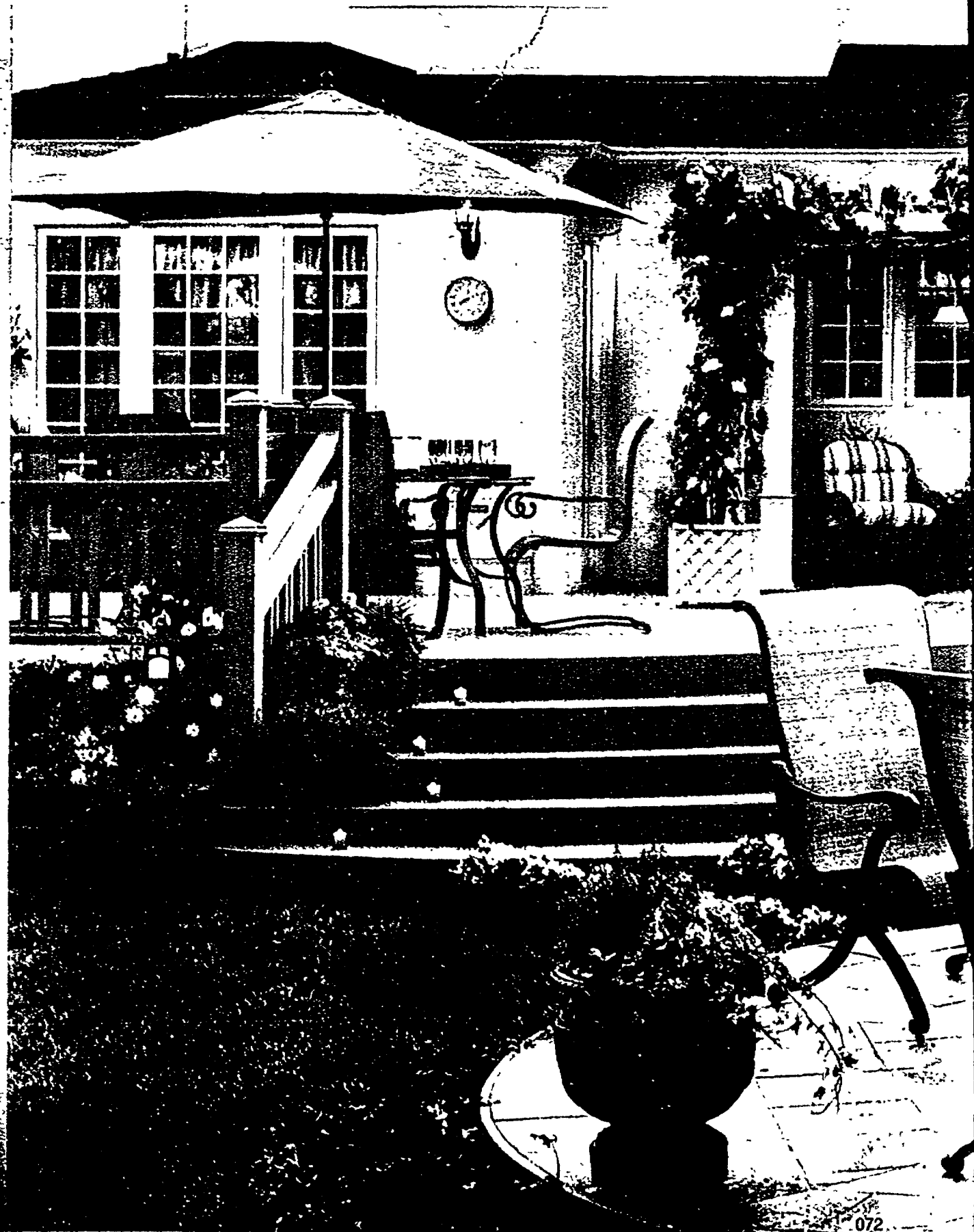

EVERY SEASON STARTS AT

# DICK'S Sporting Goods Right on Target



**Save \$120** When Purchased as a Package  
**299.98**  
 Reg. 319.99

**MagCat Bow Package**

- RH 28"-30", 50-60 lb. or 60-70 lb. draw
- Includes 3-pin sight, prong rest, quiver and string accessory kit

If purchased separately a \$419.99 value

**Save \$100** When Purchased as a Package  
**579.98**  
 Reg. 679.99

**Justice Bow Package**

- RH 28"-30", 60-70 lb. draw
- Includes TRUGLO 3-pin fiber-optic sight, OS Whisker Bisquit rest, camo quiver, vibration-dampening kit and string accessory kit

If purchased separately a \$680 value

**Save 50%** **19.98**  
 Orig. 39.99 Now 19.99

**SPECIAL PURCHASE Eliminator Arrows**

- 6-pack
- Durable camo finish
- Includes inserts

**Save 50%** **12.48**  
 Reg. 24.99

**Your Choice**

**A. Premier Broadheads**

- 3-pack • 3 vented steel blades
- 75, 100 or 125 gram

**B. Assassin Broadheads**

- 3-pack • High-carbon steel
- Power Point tip and 3-blade design • 100 gram

**Sale** **24.98**  
 Reg. 29.99

**Single-Camo Bow Case**

- Holds 12 arrows
- Foam-padded interior

Includes FREE arrow box a \$14.99 value (arrows not included)

**Save 25%** **49.98**  
 Reg. 66.99

**6-Point Buck 3D Archery Target**

- Durable foam construction
- Withstands thousands of shots

**Save \$10** **149.98**  
 Reg. 159.99

**YP Sport 450 Laser Rangefinder**

- 4-power magnification
- 450-yard range

**Save \$120** Of Orig. After Rebate  
**149.98 Sale Price**  
**-20.00 Mail-In Rebate**  
**129.98 Final Cost**  
 Orig. 249.99 Now 199.99

**Digital Cam Combo Pack**

- 1.5 megapixel, motor-activated digital scouting camera
- Includes lock bracket, combination lock, card reader and batteries

**FIELD & STREAM REALTREE**

**Save UP TO \$50**

**49.98**

**Your Choice**

**Adult Waterproof Bomber Jacket, Bib or Pants**

- 200g Thinsulate
- 400g Thinsulate
- 800g Thinsulate
- RealTree Hardwoods HD Green camo
- RealTree Hardwoods HD Blaze camo
- RealTree Hardwoods HD Green camo

Hardwoods HD Green  
 Youth Bomber Jacket, Bib or Pants \$39.98

**Save Up To 50% Off List**



Get MORE Benefits MORE! Apply for a Credit Rewards or Platinum Rewards Account Today!

**Save 25%** **29.98**  
 Reg. 39.99

**Your Choice NEW FOR 2006**

**A. Sentinel**

- 25"x20" platform
- Padded camo flip-up seat
- 300 lb. capacity
- Includes fall-arrest
- a \$19.99 value

**B. 16' Climbing Stick**

- 300 lb. capacity • Four 4' sections
- Attaches to tree securely with stabilizing straps

**Save 50%** **49.98**  
 Orig. 99.99 Now 49.99

**15' Hunter**

- Mossy Oak Break-Up padded seat
- Three 5' ladder sections
- 300 lb. capacity
- Includes full-body fall-restraint a \$19.99 value

**Save \$120** Of Orig. **129.98**  
 Orig. 249.99 Now 129.99

**Your Choice**

**A. 15' Trophy Series Magnum Dual Season**

- Oversized design • Mossy Oak Break-Up bench seat, armrests and side bags
- 300 lb. capacity
- Orig. 249.99 Now 149.99

**B. 15' Side-by-Side**

- 39"x12" foot platform • Flip-up shooting rail
- 2-person, 500 lb. capacity
- Orig. 199.99 Now 149.99

Includes full-body fall-restraint a \$19.99 value

**Save 50%** **99.98**  
 Orig. 199.99 Now 99.99

**Trophy Series Stealth Ascent**

- 27"x20" slot platform
- Adjustable, padded seat and backrest
- Includes backpack straps
- Includes full-body fall-restraint - a \$19.99 value

**Save 50%** **99.98**  
 Orig. 199.99 Now 99.99

**15' Dual Season**

- 34"x17" platform
- Adjustable seat, flip-up shooting rail and 2 camo gear bags
- Includes full-body fall-restraint - a \$19.99 value

**Save \$100** Of Orig. **149.98**  
 Orig. 249.99 Now 149.99

**Your Choice**

**A. 15' Trophy Series Condo**

- New design for 2006
- Flip-up bench-style seat
- Mossy Oak camo • 42" x 41" roof

**B. 15' Magnum Side-by-Side**

- 2-man, 500 lb. capacity
- Flip-up padded shooting rail

Includes full-body fall-restraint a \$19.99 value

**Save \$30** Of Orig. **149.98**  
 Orig. 179.99 Now 149.99

**SPECIAL PURCHASE Viper Classic**

- 20"x27.75" platform
- Camo padded seat, backrest, armrests and shooting rail
- Includes Seat-O-The-Pants safety harness a \$29.99 value

**Save \$60** Of Orig. **179.98**  
 Orig. 239.99 Now 179.99

**SPECIAL PURCHASE Cobra**

- 20"x28" platform • Weighs 18 lb
- Camo padded seat, backrest and armrests
- Includes Seat-O-The-Pants safety harness a \$29.99 value

**POWER PRICED**

**Remington 870 Express**

- Pump-action 12/20 ga • 3" chamber • 5-shot 26 7/8" vent-rib parkerized barrel

**Remington Spartan O/U**

- 12 or 20 ga • 3" chamber • Nickel receiver with bird-scene engraving

**Remington 11-87 3.5" Super Magnum**

- 12 ga • Uses 2 3/4" x 3 1/2" shells • 28" vent-rib barrel

**Save \$40** After Rebate  
**249.98 Sale Price**  
**-30.00 Mail-In Rebate**  
**219.98 Final Cost**  
 Reg. 299.99

**Save \$200** Of Orig. **399.98**  
 Orig. 599.99 Now 399.99

**Save \$250** After Rebate  
**599.98 Sale Price**  
**-50.00 Mail-In Rebate**  
**549.98 Final Cost**  
 Reg. 799.99

**Save \$40** Of Orig. **59.98**  
 Orig. 99.99 Now 59.99

**Stealth Hunter Blind**

- Scent-reducing interior with 2-person capacity
- Large viewing windows and smaller shooting portals

**Save \$50** Of Orig. **119.98**  
 Orig. 169.99 Now 119.99

**NEW FOR 2006 Illusion Blind**

- Scent-reducing interior with 2-person capacity
- Exclusive dual-camo, die-cut blur technology
- Windows with shoot-through screens

**Sale** **3.48**  
 Reg. 3.99

**Game Loads**

- 12 or 20 ga
- Box of 25

**Save 20%** **6.98**  
 Reg. 8.99

**UMC 9mm**

- Box of 50

\$5.98 per box when you buy 10 boxes or more

**Save \$130** After Rebate When Purchased as a Package  
**229.99 Now**  
**-30.00 DICK'S Mail-In Rebate**  
**199.99 Final Cost**  
 Orig. 249.99

**eTrex Legend GPS Bundle**

- Includes US topographical software, car adapter, car mount, instructional video and carry case

If purchased separately a \$330 value

**Save \$300** **499.98**  
 Reg. 799.99

**NEW FOR 2006 24-Gun Fire Safe**

- Fire protection to 1400°F
- Convertible interior
- 5 active locking bolts
- Combination lock

**Save \$50** Of Orig. **79.99**  
 Orig. 129.99

**DICK'S EXCLUSIVE Men's Panther 400**

- Waterproof leather/nylon upper
- 400g Thinsulate
- Rubber lug outsole

**Save \$30** Of Orig. **109.99**  
 Orig. 139.99

**Men's Shadow Trek 800**

- Waterproof/breathable Gore-Tex
- 800g Thinsulate
- RealTree Hardwoods HD Green camo
- Uninsulated
- Available in select southern stores

POWER PRICED

449<sup>98</sup>  
Orig. \$599.99  
Now \$499.99

**Stoeger**

**Condor O/U or Uplander S/S Matched Set**  
• 12/20 ga. • 2-barrel set  
• 3" chambers • Hardwood stock

**Save \$150**  
\$199<sup>98</sup>

**Diamond Semi**  
• 12 ga. 28" • Uses 2 3/4"-3" shells  
• Includes 5 chokes

**Diamond O/U**  
• 12/28 or 20/26 • Nickel receiver with European  
• Solid design • Deluxe walnut stock

**199<sup>98</sup>**

REMINGTONS • AMMUNITION

**Remington**

	(118 BOX CASE PRICE)	SALE	REG.
All-Purpose Shot Shells • Box of 20	2.98	3.18	3.49
Gun Club Shot Shells • Box of 25	3.98	4.28	4.99
AA or STS Loads • Box of 25	4.98	5.68	5.49
UMC .380 Auto or .38 Special • Box of 50	9.48	9.98	10.99
UMC .45 ACP or .40 S&W • Box of 50	9.98	10.98	12.99
Clay Targets • Box of 90	4.98	5.28	5.49

Case price is price per box when you buy 10 boxes or more

**Remington**

**Target Loads**  
• 12 or 20 ga  
• Box of 100

**29<sup>98</sup>**  
Orig. \$39.99  
Now \$49.99

**Ultramax Bulk Pack**  
• Choose from  
• 223 150-pack  
• 45 150-pack  
• 40 225-pack  
• 38 200-pack or  
• 9mm 250-pack

**ULTRAMAX**  
We Cover America

**ROSSI**

**Youth Matched Pair**  
• 22LR/410 ga. or 22LR/20 ga.  
• Interchangeable barrels

**Save 50%**  
\$99<sup>98</sup>

**Save**

**DICK'S EXCLUSIVE 64BXP .22LR**  
• Semi-auto 22LR • 10-round magazine  
• Laminated stock • Includes high-quality scope

**Save \$50**  
\$149<sup>98</sup>

**Save**

**DICK'S EXCLUSIVE Mark II Bolt .22LR**  
• Laminated bolt-action or laminated semi  
• Includes high-quality rifle scope

**Save \$50**  
\$149<sup>98</sup>

**Remington**

**DICK'S EXCLUSIVE 597 Scoped Combo**  
• Semi-auto 22LR • OD Green stock  
• Includes 3 9x32 scope mounted and bore-sighted

**Save \$20**  
\$149<sup>98</sup>

**Save**

**DICK'S EXCLUSIVE 93RGVXP 17HMR Combo**  
• 17 cal. bar • Heavy blind barrel • Includes variable scope

**Save \$20**  
\$229<sup>98</sup>

**ROSSI**

**DICK'S EXCLUSIVE Triple Threat**  
• 20 ga. 24.5 and 22 P • 3 barrel combo

**Save \$50**  
\$249<sup>98</sup>

**Mertis**

**30/30 Lever Action**  
• 6 shot magazine • 11.6 wood stock  
• Includes rifle scope rings and bases

**Save \$70**  
\$299<sup>98</sup>

**Remington**

**710 Scoped Combo**  
• Asorted calibers • Detachable box magazine  
• Includes Bushnell Map-Guide 3-9x21 scope

**Save \$50**  
\$349<sup>98</sup>

**DICK'S EXCLUSIVE Kodiak**  
• 50 cal. bar in line • Camo stock

**Save \$50**  
\$199<sup>98</sup>

**DICK'S EXCLUSIVE Pursuit XLT Camo Thumbhole**  
• 50 cal. bar • 28" stainless steel fluted barrel  
• Synthetic thumbhole stock • Includes scope

**Save \$130**  
\$299<sup>98</sup>

**DICK'S EXCLUSIVE Omega Camo**  
• 50 caliber with 20.9 in. camo • Thumbhole stock

**Save \$140**  
\$429<sup>98</sup>

**DICK'S EXCLUSIVE Special 500**  
• 12 ga. 28" or 20 ga. 26" • Turn head with rib barrel

**Save \$20**  
\$199<sup>98</sup>

**500 Field/Deer Combo**  
• 12 or 20 ga. • Ribbed barrel with sling  
• Includes vert. rib field barrel and 2 5x20" sport gun scope

**Save \$70**  
\$279<sup>98</sup>

**369.98 Sale Price**  
**870 Express Combo** - \$30.00 Mail-in Rebate  
• 12 or 20 ga. • Vert. rib barrel with modified choke  
• 339.98 Final Cost Reg. 375.99

**Stoeger**

**Condor O/U or Uplander S/S**  
• 12 or 20 ga. • 3" chamber and 2 chokes • Blued receiver

**Save \$100**  
\$299<sup>98</sup>

**Stoeger**

**2000 Semi**  
• 12 ga. • 3" chamber and 5 chokes  
• 26" or 28" barrel • Peabree Advantage Timber HD camo

**Save \$70**  
\$429<sup>98</sup>

**Remington**

**22LR Thunderbolts**  
• Box of 500

**9<sup>98</sup>**  
Orig. \$10.99  
Now \$13.99

**Remington**

**22 Thunderbolt**

**Remington**

**BRENEKE**

**178**  
Reg. \$19  
\$12 Ga Slugs  
• 12 ga.  
• 2 3/4"  
• Box of 5

**Remington**

**248**  
Reg. \$29  
Slugs or 00 Buck Shot  
• 12 or 20 ga.  
• Box of 5

**Save 50%**  
\$59<sup>98</sup>  
Reg. \$119.99

**Aluminum Gun Case**  
• 53" double gun case or 37" or fold-down shotgun case  
• Arise approved • 4 locking buckles

**Remington**

**998**  
Reg. \$119.99  
Now \$119.99

**3" High-Velocity Sportsman Steel Shot**  
• 12 ga.  
• Box of 25

**Save 50%**  
\$99<sup>98</sup>  
Orig. \$199.99  
Now \$119.99

**Travel Guard Wheeled Double-Rifle Case**  
• 53"x15" • Durable and impact-resistant for air-line travel  
• Heavy-duty stainless-steel lockbar

**Remington**

**998**  
Reg. \$10.99  
Now \$10.99

**Winchester or Remington High Brass Shot Shells**  
• Assorted gauges  
• 2 3/4"  
• Box of 25

**Save 50%**  
\$29<sup>98</sup>  
Orig. \$59.99  
Now \$59.99

**8x25 Pentafocus**  
• Fully-coated optics  
• "Focus free" feature stays in focus at most distances

**Save 50%**  
\$79<sup>98</sup>  
Orig. \$159.99  
Now \$99.99

**10x42 Scout**  
• Waterproof and shockproof  
• Superior multi-coated optics with wide field of view

**12x50 Scout**... 99.98  
List \$199.99 Now \$109.99

**8x25 Compact Mossy Oak Break-Up**... 59.98  
List \$99.99 Now \$59.99

**Save \$10**  
\$49<sup>98</sup>  
Orig. \$59.99  
Now \$49.99

**Your Choice World Class 3-9x40**  
Online ID# 2052644

**World Class 1.5-4.5x32**  
Online ID# 1849044

**Save 50%**  
\$99<sup>98</sup>  
Orig. \$199.99  
Now \$149.99

**Your Choice 1.5-6x32 IR**  
OR  
3-9x50 IR (shown)

**ProStaff 3-9x40 Matte**... 149.99  
(shown)  
Online ID# 1270264

**ProStaff 2-7x32**  
129.99  
Online ID# 1270263

**Save \$20**  
\$199<sup>98</sup>  
Orig. \$219.99  
Now \$199.99

**Fullfield II 3-9x40**  
• Fully-coated optics  
• Purged and nitrogen-filled  
• Ballistic Pier Reticle  
• Long-range shooting

**Save 50%**  
10.98 Sale Price  
-5.00 Mail-in Rebate  
5.98 Final Cost Reg. 11.99

**Remington Core-Lokt OR Winchester Powerpoint 30-30 Ammo**  
• 150 or 170 grain  
• Box of 20

**Remington**

**Sluggers**

**Remington**

**Express**

**Save 25%**  
10.98 Sale Price  
-3.00 Mail-in Rebate  
7.98 Final Cost Reg. 11.99

**Copper Sabots**  
• 12 or 20 ga.  
• 2 3/4"  
• Box of 5  
• Rebate valid on 2-box purchase only

**Save 25%**  
12.98 Sale Price  
-5.00 Mail-in Rebate  
7.98 Final Cost Reg. 11.99

**3" Nitro Steel Shot**  
• 12 ga.  
• Box of 25

**Save 25%**  
24.98 Sale Price  
-5.00 Mail-in Rebate  
19.98 Final Cost Reg. 26.99

**Wingmaster HD Loads**  
• 12 ga.  
• 3"  
• #2s and #4s  
• Heavier than lead  
• Rebate valid on 4-box purchase only

**Save \$10**  
\$49<sup>98</sup>  
Orig. \$59.99  
Now \$49.99

**8x21 Medallion**  
• Multi-coated optics  
• Quick central focus

**10x25 Sportstar III**... 59.98  
Orig. \$79.99 Now \$59.99

**Save \$10**  
\$99<sup>98</sup>  
Orig. \$109.99  
Now \$99.99

**10x50 Action**  
• Quick, smooth central focusing  
• Bulk 4 prisms  
• Multi-coated optics

**8x40 Action Realtree**... 89.98  
Reg. 99.99

**7x35 Action**... 69.98  
Reg. 79.99  
Online ID# 2420871

**Save \$20**  
\$99<sup>98</sup>  
Orig. \$119.99  
Now \$99.99

**10x25 Travelite V**  
• Multi-coated optics  
• Compact, rubber-coated design for easy grip

**Save \$10**  
\$69<sup>98</sup>  
Orig. \$79.99  
Now \$69.99

**Your Choice Banner 1.5-4.5x32**  
Online ID# 99702

**Banner 3-9x40 (shown)**  
Online ID# 6156

**ProStaff 3-9x40 Matte**... 149.99  
(shown)  
Online ID# 1270264

**ProStaff 2-7x32**  
129.99  
Online ID# 1270263

**Save \$20**  
\$199<sup>98</sup>  
Orig. \$219.99  
Now \$199.99

**Fullfield II 3-9x40**  
• Fully-coated optics  
• Purged and nitrogen-filled  
• Ballistic Pier Reticle  
• Long-range shooting

**FREE \$32 Landmark Binoculars** a \$99.99 value

SAFES • SCENTS

**Save \$100**  
\$999<sup>98</sup>  
ID# 2370197

**45-Gun Fire Safe**  
• Electronic lock  
• Fire protection to 1400°F  
Reg. \$1099.99

**Save \$100**  
\$799<sup>98</sup>  
ID# 2258211

**36-Gun Fire Safe**  
• Convertible interior  
• Fire protection to 1400°F  
Reg. \$899.99

**Save \$100**  
\$299<sup>98</sup>  
ID# 2258213

**16-Gun Safe**  
• Solid steel  
• 5 large locking bolts  
Orig. \$399.99 Now \$299.99

**Save \$20**  
\$79<sup>98</sup>

**10-Gun Cabinet**  
• 3 point locking system  
• Solid steel construction  
Reg. 99.99

**Save 50%**  
\$19<sup>99</sup>  
Orig. \$39.99

**Scent-Elimination Kit**  
• 3 step process  
• Includes 16 oz. clothes wash, 16 oz. hair/body soap and No Scent clothes/body spray

**Save \$100**  
\$999<sup>98</sup>  
ID# 2370197

**45-Gun Fire Safe**  
• Electronic lock  
• Fire protection to 1400°F  
Reg. \$1099.99

**Save \$100**  
\$799<sup>98</sup>  
ID# 2258211

**36-Gun Fire Safe**  
• Convertible interior  
• Fire protection to 1400°F  
Reg. \$899.99

**Save \$100**  
\$299<sup>98</sup>  
ID# 2258213

**16-Gun Safe**  
• Solid steel  
• 5 large locking bolts  
Orig. \$399.99 Now \$299.99

**Save \$20**  
\$79<sup>98</sup>

**10-Gun Cabinet**  
• 3 point locking system  
• Solid steel construction  
Reg. 99.99

**Save 50%**  
\$14<sup>98</sup>  
Orig. \$29.99

**Road Trips Scent-Control Travel Kit**  
• Includes shampoo, body soap, deodorant, razor and carrying case

**Save \$100**  
\$999<sup>98</sup>  
ID# 2370197

**45-Gun Fire Safe**  
• Electronic lock  
• Fire protection to 1400°F  
Reg. \$1099.99

**Save \$100**  
\$799<sup>98</sup>  
ID# 2258211

**36-Gun Fire Safe**  
• Convertible interior  
• Fire protection to 1400°F  
Reg. \$899.99

**Save \$100**  
\$299<sup>98</sup>  
ID# 2258213

**16-Gun Safe**  
• Solid steel  
• 5 large locking bolts  
Orig. \$399.99 Now \$299.99

**Save \$20**  
\$79<sup>98</sup>

**10-Gun Cabinet**  
• 3 point locking system  
• Solid steel construction  
Reg. 99.99

**12 oz. Scent Shield Spray**... 3.98  
Orig. \$7.99 Now \$3.99 (shown)

**12 oz. Fall Blend Cover Spray**... 4.98  
Orig. \$9.99 Now \$4.99 (shown)

**32 oz. + 12 oz. Scent Shield Combo Pack**... 7.48  
Orig. \$16.99 Now \$7.48

**32 oz. + 12 oz. Fall Blend Combo Pack**... 8.48  
Orig. \$16.99 Now \$8.48

**Save \$100**  
\$999<sup>98</sup>  
ID# 2370197

**45-Gun Fire Safe**  
• Electronic lock  
• Fire protection to 1400°F  
Reg. \$1099.99

**Save \$100**  
\$799<sup>98</sup>  
ID# 2258211

**36-Gun Fire Safe**  
• Convertible interior  
• Fire protection to 1400°F  
Reg. \$899.99

**Save \$100**  
\$299<sup>98</sup>  
ID# 2258213

**16-Gun Safe**  
• Solid steel  
• 5 large locking bolts  
Orig. \$399.99 Now \$299.99

**Save \$20**  
\$79<sup>98</sup>

**10-Gun Cabinet**  
• 3 point locking system  
• Solid steel construction  
Reg. 99.99

Online Exclusive

# VISIT OUR ONLINE LODGE

FOR NEW HUNTING TECHNOLOGY AND OUTDOOR ESSENTIALS

Bows • Arrows • Broadheads • Targets • Treestands • And Much More

Dick's Sporting Goods.com

## > BOW PACKAGES

**229<sup>99</sup>**  
**Youth Pioneer Bow Package**  
 • RH 17"-22"  
 15-29 lb. draw  
 • Includes 3-pin fiber-optic sight, QS Whisker bowcut rest, 4-arrow quiver, 3 arrows and string accessory kit



**Save \$10**  
**289<sup>98</sup>**  
 Reg. 299.99  
**NEW FOR 2006 Youth Odyssey Bow Package**  
 • RH 21"-26"  
 35-50 lb. draw  
 • Includes 3-pin fiber-optic sight, 4-arrow camo quiver, QS Whisker bowcut rest, 3 carbon arrows, string accessory kit

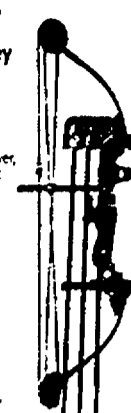

**Save \$50**  
**199<sup>98</sup>**  
 Reg. 249.99  
**TR3000 Bow Package**  
 • RH 28" 30"  
 50-60 lb. draw or 60-70 lb. draw  
 • Includes 3-pin fiber-optic sight, prong rest and 4-arrow quiver



**Save \$100** When Purchased as a Package  
**399<sup>98</sup>**  
 Reg. 499.99  
**Reflex Bow Package**  
 • RH 27" 30" 50 lb. draw or 60-70 lb. draw  
 • Includes TRUKALO 3-pin fiber-optic sight, camo quiver, stabilizer and string accessory kit

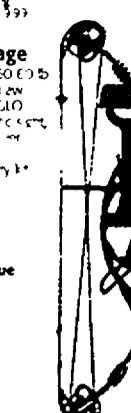

If purchased separately a \$499.99 value

**Save \$130** When Purchased as a Package  
**499<sup>98</sup>**  
 Reg. 629.99  
**NEW FOR 2006 Instinct Bow Package**  
 • RH 28"-30"  
 60-70 lb. draw  
 • Includes Trophy Ridge 3-pin fiber-optic sight, Drop Zone rest, Hurrer stabilizer, Sins Limb Savers, quiver, wrist sling and string accessory kit



If purchased separately a \$630 value

## > TREESTANDS • ACCESSORIES

**Save \$10**  
**59<sup>98</sup>**  
 Reg. 69.99  
**Big Foot**  
 • 25"x24" platform  
 • Flip-up, extra-large padded seat  
 • 300 lb. capacity



Includes full-body fall-restraint a \$19.99 value

**Save \$10**  
**79<sup>98</sup>**  
 Reg. 89.99  
**Big Foot Extreme**  
 • 24"x30" platform  
 • Weighs 20 lb.  
 • Flip-up padded seat



Includes full-body fall-restraint a \$19.99 value

**Save \$30** Off Orig.  
**89<sup>98</sup>**  
 Orig. \$119.99 Now \$89.99  
**NEW FOR 2006 Trophy Series Look Out**  
 • 29"x23" bear-top style platform  
 • 16"x10" Flip-up seat



Includes full-body fall-restraint a \$19.99 value

**Save \$10**  
**249<sup>98</sup>**  
 Reg. 259.99  
**Viper SS**  
 • 28"x20" platform  
 • RapidClimb climbing system  
 • Includes Summit skin



Includes Seat-O-The-Pants fall-restraint a \$29.99 value

**Save 25%**  
**148**  
 Reg. 199  
**Step-Up Tree Step**  
 • Tapered, self-tapping screws for easy installation  
 • Knurled surface for sure footing

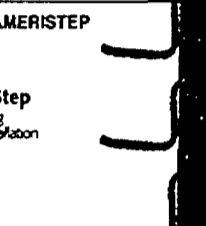

Grizzly Tree Step... 1.98 Reg. 2.99

**Save \$10**  
**59<sup>98</sup>**  
 Reg. 69.99  
**Hitch-Haul Trailer**  
 • 20"x60" solid-steel platform  
 • 500 lb. capacity  
 • Expanded metal mesh floor



**Save \$10**  
**59<sup>98</sup>**  
 Reg. 69.99  
**Treestalker Harness Vest**  
 • Easy to put on in seconds  
 • Enclosed straps  
 • Fully adjustable



## > TARGETS

**Save \$10**  
**89<sup>98</sup>**  
 Reg. 99.99  
**Layered Tuff Buck 3D Target**  
 • Can be shot from either side  
 • Durable layered foam replacement core



ID# 2417129

**Save \$10**  
**109<sup>98</sup>**  
 Reg. 119.99  
**Broadhead Buck 3D Target**  
 • One-handed arrow removal  
 • Replaceable layered-foam core works with fieldports and broadheads



ID# 2417126

**Save \$50** Off Orig.  
**149<sup>98</sup>**  
 Orig. \$199.99 Now \$149.99  
**Glendel Deer 3D Target**  
 • Broadheads or fieldports  
 • Rotate or flip face layers when shot



**THE BLOCK**

**Save \$10**  
**69<sup>98</sup>**  
 Reg. 79.99  
**Back Woods Buck 3D Target**  
 • Tech-flex foam for durability and easy arrow removal  
 • Replaceable vinyl  
 • Life size



Huge Cube... 14.98 Reg. 19.99

**Save 35%**  
**24<sup>98</sup>**  
 Reg. 39.99  
**Layered Archery Target**  
 • 20"x16"x11"  
 • Use with broadheads or field tips



26"x26"x14" Layered Target... 79.98 Orig. \$99.99 Now \$99.99

**69<sup>99</sup>**  
**The Block Portable**  
 • 18"x18"x14"  
 • Layered foam is perfect for field ports or broadheads



4x4 Portable... 99.99

**Sale**  
**17<sup>98</sup>**  
 Reg. 19.99  
**Tough Bag Target**  
 • Great for broadheads or field points



Carbon Giant Target... 34.98 Reg. 39.99  
 XL Monster Tough Bag... 24.98 Reg. 29.99

## > BROADHEADS • ACCESSORIES

**Save 25%**  
**29<sup>98</sup>**  
 Reg. 39.99  
**Whisker Bisquit Arrow Rest**  
 • Quick-shot design  
 • Feathers and vanes pass easily through the rest



**Save 20%**  
**16<sup>98</sup>**  
 Reg. 21.99  
**DICK'S EXCLUSIVE KillZone Broadheads**  
 • 3-pack  
 • Flies like a fieldpoint  
 • 100 gran



**29<sup>99</sup>**  
**Montec Broadheads**  
 • 3-pack  
 • 1-piece construction  
 • 100 gran



Tekan II Broadheads... 31.99

**Sale**  
**14<sup>98</sup>**  
 Reg. 17.99  
**Muzzy Broadheads**  
 • Razor-sharp replaceable blade system  
 • 100, 125 gran



Includes FREE practice blades a \$5.99 value

**19<sup>99</sup>**  
**NEW FOR 2006 MX4 Broadheads**  
 • 3-pack  
 • 100 gran



**Sale**  
**29<sup>98</sup>**  
 Reg. 32.99  
**Muzzy Broadheads**  
 • 6-pack  
 • Fixed blade broadheads  
 • 100, 125 gran



Includes FREE practice blades a \$5.99 value

**Sale** After Rebate  
**34.99 Now -3.00 Mail-in Rebate -10.00 Mail-in Rebate 31.99 Final Cost**  
**DICK'S EXCLUSIVE REBATE Thunder Head Broadheads**  
 • 6-pack  
 • 85 100 125 gran

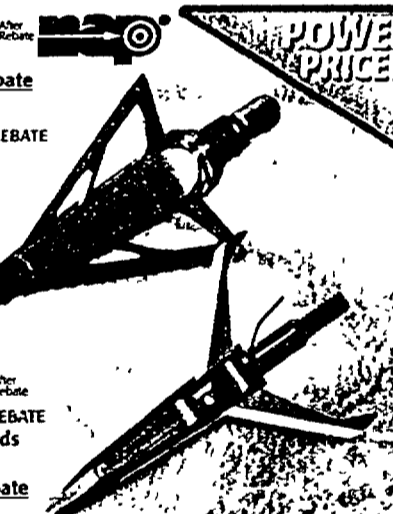

## > ARROWS • CASES • SCOUTING CAMERAS

**Save 25%**  
**14<sup>98</sup>**  
 Reg. 19.99  
**Fall Stalker Aluminum Arrows**  
 • 6-pack  
 • Cut to length  
 • Includes inserts  
 • Assorted sizes



**Sale** Off Orig.  
**29<sup>98</sup>**  
 Orig. \$34.99 Now \$29.99  
**XX75 Aluminum Arrows**  
 • 6-pack  
 • Cut to length  
 • Includes inserts

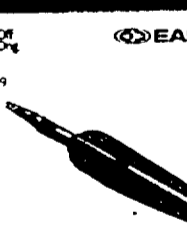

ID# 2417112

**Save 60%** Off Orig. After Rebate  
**39.98 Sale Price -10.00 Mail-in Rebate 29.98 Final Cost**  
**Stealth Cam Scouting Camera**  
 • 1/2" red motion detector  
 • 1/2" wide field of view  
 • 1/2" lens  
 • 1/2" sensor  
 • 1/2" sensor



**Save 50%** Off Orig. After Rebate  
**59.98 Sale Price -10.00 Mail-in Rebate 49.98 Final Cost**  
**0.3 Megapixel Digital Scouting Camera**

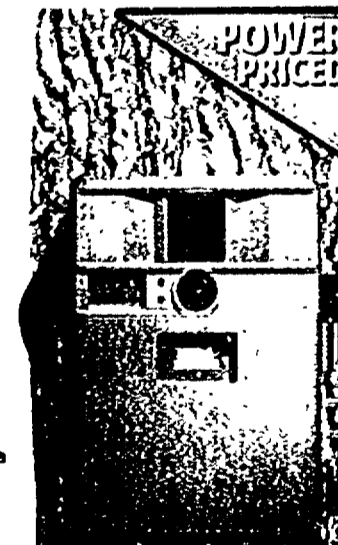

**Sale**  
**24<sup>98</sup>**  
 Reg. 29.99  
**Black Carbon Arrows**  
 • 6-pack  
 • 4/16 OOS straightness  
 • Includes inserts



**Advantage Timber HD Camo Carbon Arrows... 34.98**  
 • 6-pack Reg. 39.99

**Sale**  
**34<sup>98</sup>**  
 Reg. 39.99  
**ST Epic Carbon Arrows**  
 • 6-pack  
 • Cut to length  
 • Slim tech system



**Save 20%**  
**39<sup>98</sup>**  
 Reg. 49.99  
**Pro Max Single-Bow Case**  
 • 12 arrows  
 • 12 arrows



ID# 2406438

## > RADIOS • GPS UNITS • RANGEFINDERS

**Save 50%** Off List After Rebate  
**39.98 Sale Price -10.00 Mail-in Rebate 29.98 Final Cost**  
**8-MILE RANGE T5000GR Radio 2-Pack**  
 • Includes 2 NiCd rechargeable batteries, dual-pocket charging station and 2 ear buds

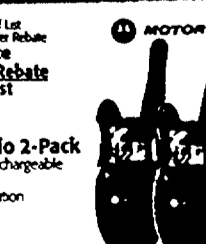

ID# 1789493

**Save \$60** After Rebate When Purchased as a Package  
**84.98 Sale Price -15.00 Mail-in Rebate 69.98 Final Cost**  
**18-Mile Range Radio Value Pack**  
 • Includes 2 NiCd rechargeable batteries, dual-pocket charging station, 2 headsets and car adapter

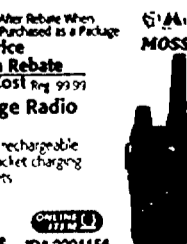

If purchased separately a \$129.99 value

ID# 2291156

**Save \$20** Off Orig.  
**99<sup>99</sup>**  
 Reg. 119.99  
**eTrex GPS Unit**  
 • 12 pins of chassis  
 • Top computer  
 • Drive time  
 • 100 points



ID# 84875

**Save \$150** After Rebate When Purchased as a Package  
**349.99 Now -50.00 Mail-in Rebate 299.99 Final Cost**  
**eTrex Legend CX Bundle**  
 • Full color display  
 • Includes US topographical software, user adapter and carry case



If purchased separately a \$450 value

**Forerunner 205 GPS Personal Training Device... 249.99** Online ID# 2187143

**Save \$40** After Rebate When Purchased as a Package  
**74.98 Sale Price -15.00 Mail-in Rebate 59.98 Final Cost**  
**12-MILE RANGE T7400 Radio Value Pack**  
 • Includes 2 NiMH rechargeable batteries, dual-pocket charging station and 2 ear buds

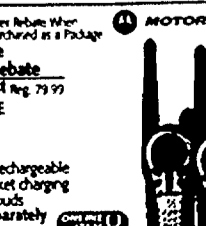

If purchased separately a \$99.99 value

ID# 2300555

**199<sup>99</sup>**  
**ProStaff Laser 440 Rangefinder**  
 • Multi-coated lens optics  
 • 440 yard range with +/- 1/2 yard accuracy  
 • Water resistant



ID# 1814894

**Save \$250** Off Orig.  
**449<sup>98</sup>**  
 Reg. 699.99  
**Street Pilot C330 Navigation System**  
 • Automatic navigation  
 • Detailed North American street data with over 5 million points of interest  
 • Includes 128MB SD card and Map Source City Select CD-ROM



ID# 1969470

STORE HOURS:

Mon thru Sat 9am to 9:30pm  
Sun 10am to 7pm

SALE EFFECTIVE

10	11	12	13	14	15	16
9	10	11	12	13	14	15

SALE EFFECTIVE



EVERY SEASON STARTS AT

**DICK'S**  
SPORTING GOODS

**39.98**

Men's LooseGear  
Camo Long-Sleeve  
Shirt

ONLINE  
ITEM ID# 2436455

Men's ColdGear  
Camo MockNeck...\$9.99

Men's ColdGear Realtree  
Camo Leggings...\$4.99  
Online ID# 1980814

Men's ColdGear  
Fleece Jacket...\$9.99

Realtree or Mossy Oak  
Break-Up Camo Hat  
\$4.99

ColdGear  
Camo Gloves  
\$8.99

REALTREE MOSSY OAK

**UNDER ARMOUR**  
PERFORMANCE

**Dress in Layers.**

Stay Dry, Warm and Scent-Free  
in Any Conditions.

> SCENT ELIMINATION

Save up to \$70  
**79.98**

Your Choice  
Scent-Lok Lite  
Jacket or Pants

Scent-eliminating  
Savanna DT  
Lightweight,  
quiet and breathable  
Mossy Oak Break-Up  
camo (shown)  
List \$119.99 Now \$99.99  
OR

No Scent Extreme  
Hunter Jacket or Pants

Waterproof/breathable  
and super quiet  
Pants feature an extra-high  
back with pockets for  
heat pads (not included)  
List \$149.99 Now \$99.99  
✓ Double ScoreCard Points

**159.99**

Your Choice  
A. Dream Season  
Jacket

Scent-eliminating  
construction  
Super-soft, extremely  
quiet Dream Fleece  
Water repeller

B. Dream Season  
Pants...\$149.99

Road Trips  
Fleece Jacket  
\$59.99

Road Trips  
Fleece Pants  
\$149.99

Non-Fleece Items  
Available in  
Select Stores  
Jacket...\$149.99  
Pants...\$139.99

SCENT BLOCKER  
FIELD & STREAM  
MOSSY OAK  
REALTREE

Save \$50  
**39.98**

No Scent  
Fleece Jacket  
or Pants

Super-quiet,  
wind-blending and  
breathable laminate  
✓ Double  
ScoreCard Points

FIELD & STREAM  
MOSSY OAK  
REALTREE

> RAINWEAR

**69.98**  
List \$139.99  
Now \$99.99

NEW FOR 2006  
2.5-Layer Packable  
Camo Rain Jacket

Waterproof/breathable (shown)

2.5-Layer Camo Pants  
\$9.98

Waterproof/breathable  
Orig \$119.99 Now \$99.99

2-Piece Camo Rainsuit  
\$9.98

Waterproof/breathable  
Orig \$159.99 Now \$99.99

Sherbrooke Plus Rain Set  
\$9.98

Waterproof/breathable  
Orig \$79.99

100% Waterproof/  
Breathable

Includes 6"x12 3/4"  
stuff pack

FIELD & STREAM  
MOSSY OAK

> CAMO

Save up to 33%  
**24.98**

Select Camo  
Hunting Apparel

Realtree camo shirts and  
pants from Winchester  
Stealth Weave shirts  
and pants from  
Mossy Oak Apparel  
Shirts and pants in  
new digital camo patterns  
Sherbrooke camo jackets  
and bibs from Prestige  
Reg. \$99.99-\$139.99

Save 40%  
**29.98**

Camo  
Sweat Jacket

Heavy-duty  
fleece  
Waffle knit  
lining  
Motion Fit  
system for  
full range  
of motion  
✓ Double  
ScoreCard  
Points

Save 25%  
**59.99**

Underbrush  
3D Leaf-Cut  
Bugmaster  
Suit

Includes  
jacket,  
pants and  
head cover  
Visor  
Pro Head  
Cover...\$14.99

Save \$10  
**59.98**

Sunrise  
2-Ply Wader

400g deated  
bootfoot  
Durable 420D  
nylon  
Molded foam  
kneepads  
Mossy Oak  
Break-Up camo

Save \$20  
**79.98**

Camo Neoprene  
Bootfoot Waders

3.5mm neoprene  
upper  
600g Thinsulate  
bootfoot  
Molded, cushioned  
knee pads  
Camo pattern  
varies by store

Save \$5  
**19.98**

Men's  
Camo Technical  
Long-Sleeve Tee

Scent inhibitor  
Stay-dry  
Synetics  
Mossy Oak  
Break-Up camo  
Short-Sleeve...\$17.98  
List \$29.99 Now \$19.99  
Online ID# 2220294

Save \$5  
**15**

A. All Work Pants

Choose from Carhartt,  
Saf-T-Bak and Wangler  
Excludes clearance

Save \$5  
**15**

B. Carhartt Bibs  
and Jackets

Excludes clearance

Save \$10  
**59.98**

Men's  
Trophy  
Hunter 1000

1000g Thinsulate  
Waterproof/breathable  
Core-Tex  
Brown or camo  
✓ Double  
ScoreCard  
Points

Save \$20  
**119.99**

Men's SSX  
Sport Stalker EXT

400g Thinsulate  
Uninsulated available  
in select Southern stores  
ONLINE  
ITEM ID# 2076092

Save \$80  
**79.99**

Men's  
Timberwolf  
Pro Hunter 600

Waterproof/breathable  
Core-Tex  
800g Thinsulate  
Vibram outsole  
Wigwam 40°  
Below  
Socks...\$9.99

Save \$100  
**79.99**

Men's  
BuckShot 600

Waterproof/breathable  
Core-Tex  
New Vibram  
outsole  
Camo available in  
select stores

Save \$10  
**79.99**

Men's 6" Waterproof  
Soft Toe

Waterproof nubuck  
upper  
400g Thinsulate

Save \$33  
**39.99**

Men's or Women's  
Cascade II

Slip-on mocs  
100g Thinsulate  
✓ Double  
ScoreCard  
Points

Save \$10  
**59.99**

Men's  
Arlida Oxford

Leather/synthetic  
upper  
Durable lug  
outsole

Save \$10  
**49.99**

Men's  
Swamp Tracker 200

Scent-free  
rubber upper  
200g Thinsulate  
Rubber outsole

Save 25%  
**59.99**

DICK'S  
EXCLUSIVE  
Men's Swamp Tracker 400

Scent-free  
rubber upper  
400g Thinsulate  
Rubber outsole

Save \$10  
**69.99**

Men's  
Harrison Work Boots

Full-grain  
leather upper  
Seed toe

Save \$10  
**89.99**

Men's Pro 6" Pit Boss

Oiled, full-grain  
leather upper  
Timberland PRO  
rubber outsole

Save \$20  
**69.99**

Men's  
White Ledge

Hiking shoe  
Premium,  
waterproof  
leather  
upper  
Dual-density  
EVA midsole

Save \$10  
**119.99**

Men's  
Chameleon Wrap XCR

Breathable  
and waterproof  
Core-Tex  
PCR

Save \$80  
**119.99**

Men's  
Timberwolf  
Pro Hunter 600

Waterproof/breathable  
Core-Tex  
800g Thinsulate  
Vibram outsole

Save \$10  
**59.99**

Men's  
Arlida Oxford

Leather/synthetic  
upper  
Durable lug  
outsole

Save \$10  
**49.99**

Men's  
Swamp Tracker 200

Scent-free  
rubber upper  
200g Thinsulate  
Rubber outsole

Save 25%  
**59.99**

DICK'S  
EXCLUSIVE  
Men's Swamp Tracker 400

Scent-free  
rubber upper  
400g Thinsulate  
Rubber outsole

Save \$10  
**69.99**

Men's  
Harrison Work Boots

Full-grain  
leather upper  
Seed toe

Save \$10  
**89.99**

Men's Pro 6" Pit Boss

Oiled, full-grain  
leather upper  
Timberland PRO  
rubber outsole

Save \$20  
**69.99**

Men's  
White Ledge

Hiking shoe  
Premium,  
waterproof  
leather  
upper  
Dual-density  
EVA midsole

Save \$10  
**119.99**

Men's  
Chameleon Wrap XCR

Breathable  
and waterproof  
Core-Tex  
PCR

Shop us online at DicksSportingGoods.com or order by phone at 1.877.846.9997

# **Tests That Can Help Save Your Life**

## **4 Tests in Less Than 1 Hour**

Stroke is America's third leading killer. It is also the #1 cause for nursing home admissions. Unfortunately, half of all stroke victims have no warning signs before a stroke occurs.

***We'll be in Your Neighborhood!***

**Where: First Baptist Church of Novi**

**When: Friday, September 22, 2006**

**Pre-registration is required. Call 1-800-710-1913**

Source Code: FMFS-002

Life Line Screening is America's leading provider of quality health screenings. These tests quickly detect arterial abnormalities which can cause disrupted blood flow. Our screenings are fast, accurate, and available at an affordable rate.

*We provide these non-invasive, completely painless screenings using Doppler ultrasound technology.*

### **1 Stroke Screening/ Carotid Artery**

This screens the carotid arteries in the neck for plaque buildup. The #1 cause of stroke is linked to carotid artery blockage.

### **2 Abdominal Aortic Aneurysm Screening**

This screens for the existence of an aneurysm in the abdominal aorta. The vast majority of people who have an aneurysm have no symptoms.

*Complete details on reverse side.*

### **3 Peripheral Arterial Disease Screening**

This screens for peripheral arterial disease (plaque buildup) in the lower extremities which is linked to coronary artery disease.

**Also... Identify your risk for osteoporosis in just 60 seconds**

 **Life Line Screening**  
Protect your health. Protect your life.®

Visit Our Web Site: [www.lifelinescreening.com](http://www.lifelinescreening.com)

**"How can I thank you for my life? I had NO previous symptoms to indicate such a problem."**

Judith Hanlon,  
Wayland, MI



A physician typically will not order an ultrasound evaluation for someone who has no symptoms of vascular disease or osteoporosis. Life Line Screening® enables you to be checked for vascular disease or osteoporosis as part of your own personal prevention plan. Over 4 million people have participated in these non-invasive and completely painless screenings. This valuable information will help you and your personal physician quickly and inexpensively manage your wellness.

- State-of-the-art equipment is used with sophisticated color flow ultrasound technology.
- A board certified physician, who is fully insured and licensed to practice, reviews and confirms all screening results.

"Vascular screening programs for cerebrovascular disease, aortic aneurysms and peripheral vascular disease have proven their value in detecting previously unrecognized problems in many individual patients that could have resulted in significant illness or even death."

*Robert J. Steele, M.D.*

*Board Certified Cardiologist, Cleveland, Ohio*

"I participated in all three screenings and felt the staff was very professional, efficient and gracious. This certainly is a valuable service which I shall continue to provide to Laurel Lake residents and to the community for as long as possible."

*Kathy Burmeister, R.N.*

*Director of Clinic Services, Hudson, Ohio*

**1 Stroke Screening/  
Carotid Artery \$45**

Visualizes the buildup of fatty plaque in the carotid arteries which leads to stroke.

**Procedure:** The technologist applies an acoustic gel on your neck over your carotid arteries. A painless instrument, a transducer, will be moved around your neck to visualize the inside of the carotid artery.

**2 Abdominal Aortic  
Aneurysm (AAA)  
Screening \$45**

Visualizes the existence of an aneurysm (enlargement) in the abdominal aorta that could lead to a ruptured aortic artery.

**Procedure:** The technologist applies an acoustic gel on your abdomen and uses a painless instrument called a transducer to visualize the aorta.

**3 Peripheral Arterial  
Disease  
Screening \$45**

Screens for peripheral arterial disease in the lower extremities. Studies suggest an abnormal ABI may indicate peripheral arterial disease as well as a high risk of coronary artery disease.

**Procedure:** Blood pressure cuffs and a Doppler ultrasound probe are placed on your arms and ankles.

**4 Osteoporosis  
Screening \$35**

Screens for abnormal bone mass density in men and women. Osteoporosis is painless and silent in its early stages.

**Procedure:** By placing your foot in an ultrasound unit, the bone density of the heel is measured with ultrasound.

**Complete Vascular Package (all 3 screenings) \$109**

**Sign up for all four screenings  
and pay only \$129! Save \$41**



Cards

If you pay by phone, we accept these credit cards and checks by phone.

Our goal is to make people aware of an undetected health problem and encourage them to seek follow-up care with their physician. You will receive your results within 21 days. Screenings in Kansas are performed by Life Line Screening of America, LLC on behalf of Life Line Screening Physicians, P.A.

**Insurance Note:** At the present time, Medicare does not cover the cost of these screening services. Life Line Screening does not file insurance claims.

# Wildflowers

BAKERY & CAFE

FRESH SALADS, SOUPS & SANDWICHES  
Dine in or convenient take out.

HOMEMADE ORGANIC BREADS  
Made fresh daily. Gluten-free available.

A VARIETY OF ORGANIC COOKIES, MUFFINS & TARTS  
Both regular and sugar-free, available fresh daily.

GLUTEN-FREE PRODUCTS AVAILABLE

(248) 374-6244

43053 7 MILE RD., NORTHVILLE, MI 48167  
In Highland Lakes Plaza, East of Northville Road.  
*Open Mon.-Fri. 8-6, Sat. 9-3*

**GRAND OPENING CELEBRATION**

Saturday, Sept. 16, 9-6 and Sunday, Sept. 17, 9-4

  
wholesome food, naturally good.